



(Please scan this QR code to view the DRHP)



**DRAFT RED HERRING PROSPECTUS**

Dated April 25, 2022

(This DRHP will be updated upon filing with the RoC)

(Please read Section 32 of the Companies Act)

**100% Book Built Offer**

**UNIPARTS INDIA LIMITED**

**CORPORATE IDENTITY NUMBER: U74899DL1994PLC061753**

REGISTERED OFFICE	CORPORATE OFFICE	CONTACT PERSON	TELEPHONE AND EMAIL	WEBSITE
Gripwel House, Block – 5, Sector C 6 & 7, Vasant Kunj, New Delhi 110070, India	1 <sup>st</sup> Floor, B208, A1 & A2, Phase-II, Noida 201 305, Uttar Pradesh, India	Jatin Mahajan, Company Secretary and Compliance Officer	+ 91 120 458 1400 compliance.officer@unipartsgroup.com	www.unipartsgroup.com

**OUR PROMOTERS: GURDEEP SONI AND PARAMJIT SINGH SONI**

**DETAILS OF OFFER TO PUBLIC**

Type	Offer for Sale size	Total Offer size	Eligibility and Reservations
Offer for Sale	Up to 15,731,942 Equity Shares aggregating up to ₹ [●] million	Up to 15,731,942 Equity Shares aggregating up to ₹ [●] million	The Offer is being made pursuant to Regulation 6(1) of the SEBI ICDR Regulations. For details of share reservation among QIBs, NIIs and RIIs, see “Offer Structure” on page 414.

**DETAILS OF THE SELLING SHAREHOLDERS, OFFER FOR SALE AND WEIGHTED AVERAGE COST OF ACQUISITION**

Name of SS	Type	Number of Equity Shares Offered	WACoA (In ₹)	Name of SS	Type	Number of Equity Shares Offered	WACoA (In ₹)
The Karan Soni 2018 CG-NG Nevada Trust	PG SS	Up to 1,700,000 Equity Shares (₹ [●] million)	Nil*	Andrew Warren Code	Individual SS	Up to 177,378 Equity Shares (₹ [●] million)	105.74
The Meher Soni 2018 CG-NG Nevada Trust	PG SS	Up to 1,700,000 Equity Shares (₹ [●] million)	Nil*	James Norman Hallene	Individual SS	Up to 177,378 Equity Shares (₹ [●] million)	105.74
Pamela Soni	PG SS	Up to 2,250,000 Equity Shares (₹ [●] million)	6.27	Kevin John Code	Individual SS	Up to 177,378 Equity Shares (₹ [●] million)	105.74
Ashoka Investment Holdings Limited	Investor SS	Up to 7,180,642 Equity Shares (₹ [●] million)	88.45	Dennis Francis DeDecker	Individual SS	Up to 57,420 Equity Shares (₹ [●] million)	105.74
Ambadevi Mauritius Holding Limited	Investor SS	Up to 2,154,192 Equity Shares (₹ [●] million)	88.45	Melvin Keith Gibbs	Individual SS	Up to 41,730 Equity Shares (₹ [●] million)	105.74

\*Represents transfer by way of gift and no consideration was paid.

For the complete list of Selling Shareholders, please see “The Offer” on page 76.

**RISKS IN RELATION TO THE FIRST OFFER**

This being the first public issue of our Company, there has been no formal market for the Equity Shares of our Company. The face value of our Equity Shares is ₹ 10 each and the Floor Price and Cap Price are [●] times and [●] times of the face value of the Equity Shares, respectively. The Floor Price, Cap Price and the Offer Price (as determined and justified by our Company and the Investor Selling Shareholders in consultation with the BRLMs, in accordance with SEBI ICDR Regulations, and as stated in “Basis of Offer Price” on page 105) should not be taken to be indicative of the market price of the Equity Shares after the Equity Shares are listed. No assurance can be given regarding an active and/ or sustained trading in the Equity Shares or regarding the price at which the Equity Shares will be traded after listing.

**GENERAL RISK**

Investments in equity and equity-related securities involve a degree of risk and investors should not invest any funds in the Offer unless they can afford to take the risk of losing their entire investment. Investors are advised to read the risk factors carefully before taking an investment decision in the Offer. For taking an investment decision, investors must rely on their own examination of our Company and the Offer including the risks involved. The Equity Shares offered in the Offer have not been recommended or approved by the SEBI, nor does the SEBI guarantee the accuracy or adequacy of the contents of this DRHP. Specific attention of the investors is invited to “Risk Factors” on page 27.

**ISSUER’S AND SELLING SHAREHOLDERS’ ABSOLUTE RESPONSIBILITY**

Our Company, having made all reasonable inquiries, accepts responsibility for and confirms that this DRHP contains all information with regard to our Company and the Offer, which is material in the context of the Offer, that the information contained in this DRHP is true and correct in all material aspects and is not misleading in any material respect, that the opinions and intentions expressed herein are honestly held and that there are no other facts, the omission of which makes this DRHP as a whole or any of such information or the expression of any such opinions or intentions, misleading in any material respect. Further, each Selling Shareholder, severally and not jointly, accepts responsibility for and confirms only statements and undertakings expressly made by such Selling Shareholder in this DRHP solely in relation to itself and its respective portion of the Offered Shares and confirms that such statements are true and correct in all material respects and are not misleading in any material respect. Each Selling Shareholder, severally and not jointly, does not assume any responsibility for any other statements, including without limitation, any and all of the statements made by or in relation to the Company or its business or any other Selling Shareholders or any other person, in this DRHP.

**LISTING**

The Equity Shares offered through the Red Herring Prospectus are proposed to be listed on the Stock Exchanges being BSE Limited and National Stock Exchange of India Limited. For the purposes of the Offer, the Designated Stock Exchange shall be [●].

**BOOK RUNNING LEAD MANAGERS**

 <b>Axis Capital Limited</b>	 <b>DAM Capital Advisors Limited</b> <i>(Formerly IDFC Securities Limited)</i>	 <b>JM Financial Limited</b>
<b>Contact Person :</b> Ankit Bhatia/ Pratik Pednekar <b>Telephone :</b> +91 22 4325 2183 <b>E-mail :</b> uil.ipo@axiscap.in	<b>Contact Person :</b> Chandresh Sharma <b>Telephone :</b> +91 22 4202 2500 <b>E-mail :</b> uniparts.ipo@damcapital.in	<b>Contact Person :</b> Prachee Dhuri <b>Telephone :</b> +91 22 6630 3030/ +91 22 6630 3262 <b>E-mail :</b> uniparts.ipo@jmfml.com

**REGISTRAR TO THE OFFER**

Name of the Registrar	Contact Person	Telephone and E-mail
Link Intime India Private Limited	Shanti Gopalkrishnan	+91 22 4918 6000, uniparts.ipo@linkintime.co.in

**BID/ OFFER PROGRAMME**

<b>ANCHOR INVESTOR BIDDING DATE*</b>	[●]	<b>BID/OFFER OPENS ON*</b>	[●]	<b>BID/OFFER CLOSES ON**</b>	[●]
--------------------------------------	-----	----------------------------	-----	------------------------------	-----

\*Our Company and the Investor SS, in consultation with the BRLMs, may consider participation by Anchor Investors, in accordance with the SEBI ICDR Regulations. The Anchor Investor Bidding Date shall be one Working Day prior to the Bid/ Offer Opening Date.

\*\*Our Company and the Investor SS, in consultation with the BRLMs, may decide to close the Bid/ Offer Period for QIBs one Working Day prior to the Bid/ Offer Closing Date, in accordance with the SEBI ICDR Regulations.



## UNIPARTS INDIA LIMITED

Our Company was incorporated as "Uniparts India Limited" under the Companies Act, 1956 at Delhi, pursuant to a certificate of incorporation dated September 26, 1994 issued by the Registrar of Companies, Delhi and Haryana at Delhi ("RoC"). Our Company received a certificate of commencement of business on September 7, 1998 from the RoC. For details of change in the Registered Office, see "History and Certain Corporate Matters – Changes in the Registered Office" on page 180.

**Registered Office:** Gripwel House, Block – 5, Sector C 6 & 7, Vasant Kunj, New Delhi 110 070, India; **Tel:** +91 11 2613 7979

**Corporate Office:** 1<sup>st</sup> Floor, B208, A1 & A2, Phase-II, Noida 201 305, Uttar Pradesh, India; **Tel:** +91 120 458 1400

**Contact Person:** Jatin Mahajan, Company Secretary and Compliance Officer; **Tel:** + 91 120 458 1400

**E-mail:** compliance.officer@unipartsgroup.com; **Website:** www.unipartsgroup.com; **Corporate Identity Number:** U74899DL1994PLC061753

### OUR PROMOTERS: GURDEEP SONI AND PARAMJIT SINGH SONI

INITIAL PUBLIC OFFERING OF UP TO 15,731,942 EQUITY SHARES OF FACE VALUE OF ₹10 EACH ("EQUITY SHARES") OF UNIPARTS INDIA LIMITED ("OUR COMPANY" OR THE "ISSUER") FOR CASH AT A PRICE OF ₹ [●] PER EQUITY SHARE ("OFFER PRICE") AGGREGATING UP TO ₹ [●] MILLION, COMPRISING AN OFFER FOR SALE OF UP TO 15,731,942 EQUITY SHARES AGGREGATING UP TO ₹ [●] MILLION, COMPRISING 1,700,000 EQUITY SHARES BY THE KARAN SONI 2018 CG-NG NEVADA TRUST AGGREGATING UP TO ₹ [●] MILLION, 1,700,000 EQUITY SHARES BY THE MEHER SONI 2018 CG-NG NEVADA TRUST AGGREGATING UP TO ₹ [●] MILLION AND 2,250,000 EQUITY SHARES BY PAMELA SONI AGGREGATING UP TO ₹ [●] MILLION (COLLECTIVELY THE "PROMOTER GROUP SELLING SHAREHOLDERS"), 7,180,642 EQUITY SHARES BY ASHOKA INVESTMENT HOLDINGS LIMITED ("ASHOKA") AGGREGATING UP TO ₹ [●] MILLION AND 2,154,192 EQUITY SHARES BY AMBADEVI MAURITIUS HOLDING LIMITED ("AMBADEVI") AGGREGATING UP TO ₹ [●] MILLION, ("ASHOKA" AND "AMBADEVI" ARE TOGETHER REFERRED TO AS THE "INVESTOR SELLING SHAREHOLDERS") AND 177,378 EQUITY SHARES BY ANDREW WARREN CODE AGGREGATING UP TO ₹ [●] MILLION, 177,378 EQUITY SHARES BY JAMES NORMAN HALLENE AGGREGATING UP TO ₹ [●] MILLION, 177,378 EQUITY SHARES BY KEVIN JOHN CODE AGGREGATING UP TO ₹ [●] MILLION, 57,420 EQUITY SHARES BY DENNIS FRANCIS DEDECKER AGGREGATING UP TO ₹ [●] MILLION, 41,730 EQUITY SHARES BY MELVIN KEITH GIBBS AGGREGATING UP TO ₹ [●] MILLION, 24,706 EQUITY SHARES BY WALTER JAMES GRUBER AGGREGATING UP TO ₹ [●] MILLION, 21,556 EQUITY SHARES BY WENDY REICHAARD HAMMEN AGGREGATING UP TO ₹ [●] MILLION, 20,870 EQUITY SHARES BY MARK LOUIS DAWSON AGGREGATING UP TO ₹ [●] MILLION, 16,366 EQUITY SHARES BY BRADLEY LORENZ MILLER AGGREGATING UP TO ₹ [●] MILLION, 10,440 EQUITY SHARES BY MARY LOUISE ARP AGGREGATING UP TO ₹ [●] MILLION, 8,340 EQUITY SHARES BY DIANA LYNN CRAIG AGGREGATING UP TO ₹ [●] MILLION, 7,710 EQUITY SHARES BY MARC CHRISTOPHER DORAU AGGREGATING UP TO ₹ [●] MILLION, 5,010 EQUITY SHARES BY CRAIG A JOHNSON AGGREGATING UP TO ₹ [●] MILLION AND 826 EQUITY SHARES BY MISTY MARIE GARCIA AGGREGATING UP TO ₹ [●] MILLION (TOGETHER, THE "INDIVIDUAL SELLING SHAREHOLDERS", AND TOGETHER WITH THE PROMOTER GROUP SELLING SHAREHOLDERS AND THE INVESTOR SELLING SHAREHOLDERS ARE COLLECTIVELY, THE "SELLING SHAREHOLDERS") (THE "OFFER FOR SALE" OR THE "OFFER"). THE OFFER WILL CONSTITUTE 34.86% OF OUR POST-OFFER PAID-UP EQUITY SHARE CAPITAL.

THE PRICE BAND AND THE MINIMUM BID LOT SIZE WILL BE DECIDED BY OUR COMPANY AND THE INVESTOR SELLING SHAREHOLDERS IN CONSULTATION WITH THE BRLMS AND WILL BE ADVERTISED IN ALL EDITIONS OF [●] (A WIDELY CIRCULATED ENGLISH NATIONAL DAILY NEWSPAPER) AND ALL EDITIONS OF [●] (A WIDELY CIRCULATED HINDI NATIONAL DAILY NEWSPAPER, HINDI ALSO BEING THE REGIONAL LANGUAGE OF NEW DELHI WHERE OUR REGISTERED OFFICE IS LOCATED), AT LEAST TWO WORKING DAYS PRIOR TO THE BID/OFFER OPENING DATE AND SHALL BE MADE AVAILABLE TO THE BSE LIMITED ("BSE") AND NATIONAL STOCK EXCHANGE OF INDIA LIMITED ("NSE"), AND TOGETHER WITH BSE, THE "STOCK EXCHANGES") FOR UPLOADING ON THEIR RESPECTIVE WEBSITES IN ACCORDANCE WITH THE SECURITIES AND EXCHANGE BOARD OF INDIA (ISSUE OF CAPITAL AND DISCLOSURE REQUIREMENTS) REGULATIONS, 2018, AS AMENDED (THE "SEBI ICDR REGULATIONS").

In case of any revision in the Price Band, the Bid/ Offer Period shall be extended for at least three additional Working Days after such revision of the Price Band, subject to the total Bid/Offer Period not exceeding 10 Working Days. In cases of *force majeure*, banking strike or similar circumstances, our Company and the Investor Selling Shareholders in consultation with the BRLMs, for reasons to be recorded in writing, extend the Bid/ Offer Period for a minimum of three Working Days, subject to the Bid/ Offer Period not exceeding 10 Working Days. Any revision in the Price Band, and the revised Bid/ Offer Period, if applicable, shall be widely disseminated by notification to the Stock Exchanges by issuing a press release and also by indicating the change on the websites of the BRLMs and at the terminals of the Members of the Syndicate and by intimation to Designated Intermediaries and Sponsor Bank.

The Offer is being made in terms of Rule 19(2)(b) of the Securities Contracts (Regulation) Rules, 1957, as amended (the "SCRR"), read with Regulation 31 of the SEBI ICDR Regulations. The Offer is being made through the Book Building Process in accordance with Regulation 6(1) of the SEBI ICDR Regulations wherein not more than 50% of the Offer shall be available for allocation on a proportionate basis to Qualified Institutional Buyers ("QIBs") (the "QIB Portion"), provided that our Company and the Investor Selling Shareholders in consultation with the BRLMs may allocate up to 60% of the QIB Portion to Anchor Investors and the basis of such allocation will be on a discretionary basis by the Company and the Investor Selling Shareholders, in consultation with the BRLMs, in accordance with the SEBI ICDR Regulations (the "Anchor Investor Portion"), of which one-third shall be reserved for domestic Mutual Funds, subject to valid Bids being received from the domestic Mutual Funds at or above the price at which allocation is made to Anchor Investors ("Anchor Investor Allocation Price"). Further, 5% of the QIB Portion (excluding the Anchor Investor Portion) shall be available for allocation on a proportionate basis only to Mutual Funds, subject to valid Bids being received at or above the Offer Price, and the remainder of the QIB Portion shall be available for allocation on a proportionate basis to all QIBs (other than Anchor Investors), including Mutual Funds, subject to valid Bids being received at or above the Offer Price. Further, not less than 15% of the Offer shall be available for allocation on a proportionate basis to Non-Institutional Investors ("Non-Institutional Category") of which one-third of the Non-Institutional Category shall be available for allocation to Bidders with an application size of more than ₹ 200,000 and up to ₹ 1,000,000 and two-thirds of the Non-Institutional Category shall be available for allocation to Bidders with an application size of more than ₹ 1,000,000 and under-subscription in either of these two sub-categories of Non-Institutional Category may be allocated to Bidders in the other sub-category of Non-Institutional Category in accordance with the SEBI ICDR Regulations, subject to valid Bids being received at or above the Offer Price. Further, not less than 35% of the Offer shall be available for allocation to Retail Individual Investors ("Retail Category"), in accordance with the SEBI ICDR Regulations, subject to valid Bids being received from them at or above the Offer Price. All Bidders (except Anchor Investors) shall mandatorily participate in this Offer only through the Application Supported by Blocked Amount ("ASBA") process, and shall provide details of their respective bank account (including UPIID (defined hereinafter) in case of UPI Bidders (defined hereinafter)) in which the Bid Amount will be blocked by the Self Certified Syndicate Banks ("SCSBs") or the Sponsor Bank, as the case may be. Anchor Investors are not permitted to participate in the Anchor Investor Portion through the ASBA process. For details, see "Offer Procedure" on page 417.

### RISKS IN RELATION TO FIRST OFFER

This being the first public issue of our Company, there has been no formal market for the Equity Shares. The face value of the Equity Shares is ₹10. The Offer Price/Floor Price/Cap Price, as determined and justified by our Company and the Investor Selling Shareholders, in consultation with the BRLMs, in accordance with the SEBI ICDR Regulations and as stated in "Basis of Offer Price" on page 105 should not be taken to be indicative of the market price of the Equity Shares after such Equity Shares are listed. No assurance can be given regarding an active and/or sustained trading in the Equity Shares nor regarding the price at which the Equity Shares will be traded after listing.

### GENERAL RISKS

Investments in equity and equity-related securities involve a degree of risk and investors should not invest any funds in this Offer unless they can afford to take the risk of losing their entire investment. Investors are advised to read the risk factors carefully before taking an investment decision in this Offer. For taking an investment decision, investors must rely on their own examination of the Issuer and the Offer, including the risks involved. The Equity Shares have not been recommended or approved by the Securities and Exchange Board of India ("SEBI"), nor does SEBI guarantee the accuracy or adequacy of the contents of this Draft Red Herring Prospectus. Specific attention of the investors is invited to "Risk Factors" on page 27.

### COMPANY AND SELLING SHAREHOLDERS' ABSOLUTE RESPONSIBILITY

Our Company, having made all reasonable inquiries, accepts responsibility for and confirms that this Draft Red Herring Prospectus contains all information with regard to our Company and the Offer, which is material in the context of the Offer, that the information contained in this Draft Red Herring Prospectus is true and correct in all material aspects and is not misleading in any material respect, that the opinions and intentions expressed herein are honestly held and that there are no other facts, the omission of which makes this Draft Red Herring Prospectus as a whole or any of such information or the expression of any such opinions or intentions, misleading in any material respect. Each Selling Shareholder, severally and not jointly, accepts responsibility for and confirms only statements and undertakings expressly made by such Selling Shareholder in this Draft Red Herring Prospectus solely in relation to itself and its respective portion of the Offered Shares and confirms that such statements are true and correct in all material respects and are not misleading in any material respect. None of the Selling Shareholders assumes any responsibility for any other statement in this Draft Red Herring Prospectus, including, *inter alia*, any of the statements made by or relating to our Company or our Company's business or any other Selling Shareholder or any other person.

### LISTING

The Equity Shares offered through the Red Herring Prospectus are proposed to be listed on the Stock Exchanges. Our Company has received in-principle approvals from BSE and NSE for listing of the Equity Shares pursuant to their letters dated [●] and [●], respectively. For the purposes of the Offer, [●] shall be the Designated Stock Exchange. A signed copy of the Red Herring Prospectus and the Prospectus shall be filed with the RoC in accordance with Section 26(4) of the Companies Act, 2013. For details of the material contracts and documents available for inspection from the date of the Red Herring Prospectus up to the Bid/Offer Closing Date, see "Material Contracts and Documents for Inspection" on page 444.

### BOOK RUNNING LEAD MANAGERS

### REGISTRAR TO THE OFFER

<b>Axis Capital Limited</b> 1 <sup>st</sup> Floor, Axis House, C-2 Wadia International Centre, PB Marg, Worli, Mumbai 400 025, Maharashtra, India <b>Tel:</b> +91 22 4325 2183 <b>E-mail:</b> uil ipo@axiscap.in <b>Website:</b> www.axiscapital.co.in <b>Investor Grievance E-mail:</b> complaints@axiscap.in <b>Contact Person:</b> Ankit Bhatia/Pratik Pednekar <b>SEBI Registration No.:</b> INM000012029	<b>DAM Capital Advisors Limited</b> (Formerly IDFC Securities Limited) One BKC, Tower C, 15 <sup>th</sup> Floor, Unit no. 1511, Bandra Kurla Complex, Bandra (East), Mumbai 400 051 Maharashtra, India <b>Tel:</b> +91 22 4202 2500 <b>E-mail:</b> uniparts.ipo@damcapital.in <b>Investor Grievance E-mail:</b> complaint@damcapital.in <b>Website:</b> www.damcapital.in <b>Contact Person:</b> Chandresh Sharma <b>SEBI Registration No.:</b> MB/INM000011336	<b>JM Financial Limited</b> 7 <sup>th</sup> Floor, Chery, Appasaheb Marathe Marg Prabhadevi, Mumbai 400 025 Maharashtra, India <b>Tel:</b> +91 22 6630 3030/ +91 22 6630 3262 <b>E-mail:</b> uniparts.ipo@jmfl.com <b>Investor Grievance E-Mail:</b> grievance.ibd@jmfl.com <b>Website:</b> www.jmfl.com <b>Contact person:</b> Prachee Dhuri <b>SEBI Registration No.:</b> INM000010361	<b>Link Intime India Private Limited</b> C-101, 1 <sup>st</sup> Floor, 247 Park, L.B.S. Marg, Vikhroli West, Mumbai 400 083 Maharashtra, India <b>Tel:</b> + 22 4918 6200 <b>E-mail:</b> uniparts.ipo@linkintime.co.in <b>Investor grievance e-mail:</b> uniparts.ipo@linkintime.co.in <b>Website:</b> www.linkintime.co.in <b>Contact person:</b> Shanti Gopalkrishnan <b>SEBI Registration No.:</b> INR000004058

### BID/OFFER PROGRAMME

ANCHOR INVESTOR BIDDING DATE*	[●]	BID/OFFER OPENS ON*	[●]	BID/OFFER CLOSES ON**	[●]
-------------------------------	-----	---------------------	-----	-----------------------	-----

\* Our Company and the Investor Selling Shareholders may, in consultation with the BRLMs, consider participation by Anchor Investors. The Anchor Investors shall Bid during the Anchor Investor Bidding Date, i.e., one Working Day prior to the Bid/Offer Opening Date.

\*\* Our Company and the Investor Selling Shareholders may, in consultation with the BRLMs, consider closing the Bid/Offer Period for QIBs one day prior to the Bid/Offer Closing Date, in accordance with the SEBI ICDR Regulations.

## TABLE OF CONTENTS

<b>SECTION I – GENERAL .....</b>	<b>2</b>
<b>DEFINITIONS AND ABBREVIATIONS .....</b>	<b>2</b>
<b>CERTAIN CONVENTIONS, USE OF FINANCIAL INFORMATION AND MARKET DATA AND CURRENCY OF PRESENTATION .....</b>	<b>14</b>
<b>FORWARD-LOOKING STATEMENTS.....</b>	<b>17</b>
<b>SUMMARY OF THE OFFER DOCUMENT .....</b>	<b>18</b>
<b>SECTION II - RISK FACTORS .....</b>	<b>27</b>
<b>SECTION III – INTRODUCTION .....</b>	<b>67</b>
<b>SUMMARY FINANCIAL INFORMATION .....</b>	<b>67</b>
<b>THE OFFER.....</b>	<b>76</b>
<b>GENERAL INFORMATION .....</b>	<b>78</b>
<b>CAPITAL STRUCTURE .....</b>	<b>87</b>
<b>OBJECTS OF THE OFFER .....</b>	<b>103</b>
<b>BASIS OF OFFER PRICE.....</b>	<b>105</b>
<b>STATEMENT OF POSSIBLE SPECIAL TAX BENEFITS .....</b>	<b>108</b>
<b>SECTION IV: ABOUT OUR COMPANY .....</b>	<b>111</b>
<b>INDUSTRY OVERVIEW .....</b>	<b>111</b>
<b>OUR BUSINESS .....</b>	<b>149</b>
<b>KEY REGULATIONS AND POLICIES IN INDIA .....</b>	<b>176</b>
<b>HISTORY AND CERTAIN CORPORATE MATTERS .....</b>	<b>180</b>
<b>OUR MANAGEMENT.....</b>	<b>189</b>
<b>PROMOTER AND PROMOTER GROUP.....</b>	<b>206</b>
<b>OUR GROUP COMPANIES .....</b>	<b>210</b>
<b>DIVIDEND POLICY .....</b>	<b>211</b>
<b>SECTION V – FINANCIAL STATEMENTS .....</b>	<b>212</b>
<b>RESTATED FINANCIAL STATEMENTS .....</b>	<b>212</b>
<b>OTHER FINANCIAL INFORMATION .....</b>	<b>350</b>
<b>CAPITALISATION STATEMENT.....</b>	<b>351</b>
<b>FINANCIAL INDEBTEDNESS.....</b>	<b>352</b>
<b>MANAGEMENT’S DISCUSSION AND ANALYSIS OF FINANCIAL CONDITION AND RESULTS OF OPERATIONS.....</b>	<b>355</b>
<b>SECTION VI – LEGAL AND OTHER INFORMATION.....</b>	<b>389</b>
<b>OUTSTANDING LITIGATION AND OTHER MATERIAL DEVELOPMENTS .....</b>	<b>389</b>
<b>GOVERNMENT AND OTHER APPROVALS.....</b>	<b>393</b>
<b>OTHER REGULATORY AND STATUTORY DISCLOSURES .....</b>	<b>395</b>
<b>SECTION VII – OFFER RELATED INFORMATION .....</b>	<b>408</b>
<b>TERMS OF THE OFFER.....</b>	<b>408</b>
<b>OFFER STRUCTURE .....</b>	<b>414</b>
<b>OFFER PROCEDURE.....</b>	<b>417</b>
<b>RESTRICTIONS ON FOREIGN OWNERSHIP OF INDIAN SECURITIES .....</b>	<b>435</b>
<b>SECTION VIII - MAIN PROVISIONS OF THE ARTICLES OF ASSOCIATION.....</b>	<b>436</b>
<b>SECTION IX – OTHER INFORMATION .....</b>	<b>444</b>
<b>MATERIAL CONTRACTS AND DOCUMENTS FOR INSPECTION .....</b>	<b>444</b>
<b>DECLARATION BY THE COMPANY .....</b>	<b>447</b>

## SECTION I – GENERAL

### DEFINITIONS AND ABBREVIATIONS

*This Draft Red Herring Prospectus uses certain definitions and abbreviations which, unless the context otherwise indicates or implies, shall have the meaning as provided below. References to any legislation, act, regulation, rule, guideline, policy, circular, notification or clarification shall be to such legislation, act, regulation, rule, guideline, policy, circular, notification or clarification as amended and any reference to a statutory provision shall include any subordinate legislation made from time to time under that provision.*

*Unless the context otherwise indicates, all references to “the Company” and “our Company”, are references to Uniparts India Limited, a company incorporated under the Companies Act, 1956, and having its registered office at Gripwel House, Block – 5, Sector C 6 & 7, Vasant Kunj, New Delhi 110 070, India. Furthermore, unless the context otherwise indicates, all references to the terms, “we”, “us” and “our” are to our Company and our Subsidiaries (as defined below) on a consolidated basis.*

*The words and expressions used in this Draft Red Herring Prospectus but not defined herein, shall have, to the extent applicable, the meanings ascribed to such terms under the Companies Act, the SEBI ICDR Regulations, the SCRA, the Depositories Act or the rules and regulations made thereunder.*

*Notwithstanding the foregoing, terms in “Statement of Possible Special Tax Benefits”, “Industry Overview”, “Key Regulations and Policies in India”, “Financial Statements”, “Outstanding Litigation and Other Material Developments” and “Main Provisions of the Articles of Association”, on pages 108, 111, 176, 212, 389 and 436 will have the meaning ascribed to such terms in those respective sections.*

#### Company Related Terms

Term	Description
Ambadevi	Ambadevi Mauritius Holding Limited
Articles of Association or AoA	Articles of Association of our Company, as amended
Ashoka	Ashoka Investment Holdings Limited
Audit Committee	The audit committee of our Board, as described in “ <i>Our Management</i> ” beginning on page 196
Auditors or Statutory Auditors	Statutory auditors of our Company, namely, Rakesh Banwari & Co., Chartered Accountants
Board or Board of Directors	Board of directors of our Company or a duly constituted committee thereof
Chairman and Managing Director	The chairman and managing director of the Board of our Company, being Gurdeep Soni
Chief Financial Officer	Chief financial officer of our Company, being Munish Sapra
Company Secretary and Compliance Officer	Company secretary and compliance officer of our Company, being Jatin Mahajan
Corporate Office	The corporate office of our Company located at 1 <sup>st</sup> Floor, B208, A1 & A2, Phase-II, Noida 201 305, Uttar Pradesh, India
Corporate Social Responsibility Committee	The corporate social responsibility committee of our Board, as described in “ <i>Our Management</i> ” beginning on page 200
Director(s)	Director(s) on the Board
Equity Shares	Equity shares of our Company of face value of ₹10 each
ESOP	Employee Stock Option Plan
ESOP 2007	Uniparts Employee Stock Option Plan – 2007, as amended from time to time
Executive Directors	Executive Directors of our Company
Executive Director and Vice Chairman	The executive director and vice chairman of our Company, being Paramjit Singh Soni
GCPL	The wholly-owned subsidiary of our Company, namely Gripwel Conag Private Limited
GFPL	The wholly-owned subsidiary of our Company, namely Gripwel Fasteners Private Limited
Individual Selling Shareholders or Individual SS	Collectively, Andrew Warren Code, James Norman Hallene, Kevin John Code, Dennis Francis DeDecker, Melvin Keith Gibbs, Walter James Gruber, Wendy Reichard Hammen, Mark Louis Dawson, Bradley Lorenz Miller, Mary Louise Arp, Diana Lynn Craig, Marc Christopher Dorau, Craig A Johnson and Misty Marie Garcia
Investor Selling Shareholders or Investor SS	Together, Ashoka and Ambadevi
Independent Directors	Independent directors on our Board, and eligible to be appointed as independent

Term	Description
	directors under the provisions of the Companies Act, 2013 and the SEBI Listing Regulations. For details of the Independent Directors, see “ <i>Our Management</i> ” beginning on page 189
Investment Agreement	Investment Agreement dated September 13, 2007, entered into by and amongst our Promoters, Ambadevi, Ashoka and our Company. For details, see “ <i>History and Certain Corporate Matters - Key terms of subsisting shareholders’ agreements</i> ” on page 187
IPO Committee	The IPO committee of our Board
Kavee	Uniparts Kavee B.V., our erstwhile joint venture with Kramp
Key Managerial Personnel or KMP	Key managerial personnel of our Company in terms of Regulation 2(1)(bb) of the SEBI ICDR Regulations as disclosed in “ <i>Our Management</i> ” beginning on page 204
Kramp	Kramp Groep B.V., our erstwhile joint venture partner
Material Subsidiaries	Gripwel Fasteners Private Limited, Uniparts India GmbH (Germany), Uniparts USA Limited and Uniparts Olsen Inc.
Memorandum of Association or MoA	Memorandum of Association of our Company, as amended
Nomination and Remuneration Committee	The nomination and remuneration committee of our Board, as described in “ <i>Our Management</i> ” beginning on page 199
Nominee Director	Nominee Director of our Company
Olsen Investors	Collectively, Kevin John Code, Dennis Francis DeDecker, Andrew Warren Code, James Norman Hallene, Mark Louis Dawson, Melvin Keith Gibbs, Marc Christopher Dorau, Bradley Lorenz Miller, Walter James Gruber, Mary Louise Arp, Diana Lynn Craig, Wendy Reichard Hammen, Craig A Johnson and Misty Marie Garcia
Promoter Group	The persons and entities constituting the promoter group of our Company in terms of Regulation 2(1)(pp) of the SEBI ICDR Regulations, as disclosed in “ <i>Our Promoter and Promoter Group</i> ” beginning on page 206
Promoter Group Selling Shareholders or PG SS	Collectively, the Karan Soni 2018 CG-NG Nevada Trust (through Peak Trust Company-NV), the Meher Soni 2018 CG-NG Nevada Trust (through Peak Trust Company-NV) and Pamela Soni
Promoters	The promoters of our Company, namely, Gurdeep Soni and Paramjit Singh Soni
Registered Office	The registered office of our Company located at Gripwel House, Block – 5, Sector C 6 & 7, Vasant Kunj, New Delhi 110 070, India
Registrar of Companies or RoC	Registrar of Companies, Delhi and Haryana at Delhi
Restated Financial Statements	Restated consolidated financial statements of our Company and its subsidiaries for the nine months ended December 31, 2021 and the years ended March 31, 2021, 2020 and 2019 (prepared in accordance with Ind AS read with Section 133 of the Companies Act, 2013) which comprises the restated Ind AS consolidated statement of assets and liabilities for the nine months ended December 31, 2021 and the years ended March 31, 2021, 2020 and 2019, the restated Ind AS consolidated statement of profit and loss (including other comprehensive income) for the nine months ended December 31, 2021 and the years ended March 31, 2021, 2020 and 2019, the restated summary statement of changes in equity and the restated Ind AS consolidated statement of cash flows and notes thereto for the nine months ended December 31, 2021 and the years ended March 31, 2021, 2020 and 2019 and the summary statement of significant accounting policies, and other explanatory information
Risk Management Committee	The risk management committee of our Board, as described in “ <i>Our Management</i> ” beginning on page 202
Selling Shareholders or SS	Together, the Promoter Group Selling Shareholders, the Investor Selling Shareholders and the Individual Selling Shareholders
SHA	Shareholders’ agreement dated September 25, 2007, entered into by and amongst our Promoters, Ambadevi, Ashoka and our Company, as amended by letter agreements dated September 7, 2010 and February 18, 2013 read along with the deed of accession dated May 31, 2012 by which Karan Soni became a party to the said shareholders’ agreement dated September 25, 2007 and two separate deeds of accession, each dated July 4, 2012, by which Meher Soni became a party to the said shareholders’ agreement dated September 25, 2007, five separate deeds of accession, each dated December 27, 2018, by which Peak Trust Company – NV, Shrikant Nadkarni and Sarabjit Soni became parties to the said shareholders’ agreement dated September 25, 2007, a supplemental deed dated January 30, 2014 to the said shareholder’s agreement dated September 25, 2007 amongst our Promoters, Ambadevi, Ashoka, Karan Soni, Meher Soni and our Company and another supplemental deed dated December 27, 2018 to the said shareholder’s agreement dated September 25, 2007 amongst our Promoters, Ambadevi, Ashoka, Karan Soni, Meher Soni and our Company followed by a letter agreement dated October 10, 2019, an amendment and supplemental deed dated December 7, 2020 entered into by and amongst our Promoters, Ambadevi, Ashoka,

Term	Description
	Karan Soni, Meher Soni, Sarabjit Soni, Shrikant Nadkarni, Peak Trust Company – NV, Angad Soni, Arjun Soni, Pamela Soni, Tanya Kohli and our Company, and the amendment and termination agreement dated April 19, 2022 entered into among the parties to the SHA. For details, see “ <i>History and Certain Corporate Matters - Key terms of subsisting shareholders’ agreements</i> ” on page 187
Shareholder(s)	Equity shareholders of our Company, from time to time
Stakeholders’ Committee	Relationship The stakeholders’ relationship committee of our Board, as described in “ <i>Our Management</i> ” beginning on page 200
Subsidiaries	Subsidiaries of our Company, namely, GFPL, UUL, UIG, GCPL, UEBV and UOI
UEBV	The wholly-owned subsidiary of our Company, namely, Uniparts Europe B.V.
UIG	The wholly-owned subsidiary of our Company, namely, Uniparts India GmbH
Uniparts ESOP Trust	An employee stock option trust to administer ESOP 2007
Uniparts Group	The Company along with its Subsidiaries
UOI	The wholly-owned subsidiary of UUL, namely, Uniparts Olsen Inc.
UUL	The wholly-owned subsidiary of our Company, namely, Uniparts USA Limited

## Offer Related Terms

Term	Description
Acknowledgement Slip	The slip or document issued by the relevant Designated Intermediary(ies) to the Bidder as proof of registration of the Bid cum Application Form.
Allot/ Allotment/ Allotted	Allotment of Equity Shares pursuant to the transfer of the Offered Shares by the Selling Shareholders pursuant to the Offer for Sale to the successful Bidders.
Allotment Advice	The note or advice or intimation of Allotment sent to each successful Bidders who has been or is to be Allotted the Equity Shares after approval of the Basis of Allotment by the Designated Stock Exchange.
Allottee	A successful Bidder to whom an Allotment is made.
Anchor Investor Allocation Price	The price at which Equity Shares will be allocated to Anchor Investors according to the terms of the Red Herring Prospectus and the Prospectus, which will be decided by our Company and the Investor Selling Shareholders in consultation with the BRLMs.
Anchor Investor Application Form	The form used by an Anchor Investor to make a Bid in the Anchor Investor Portion and which will be considered as an application for Allotment in terms of the Red Herring Prospectus and the Prospectus.
Anchor Investor Bidding Date	The date, one Working Day prior to the Bid/ Offer Opening Date, on which Bids by Anchor Investors shall be submitted, prior to and after which BRLMs will not accept any Bids from Anchor Investors, and allocation to Anchor Investors shall be completed.
Anchor Investor Offer Price	The final price at which the Equity Shares will be Allotted to Anchor Investors in terms of the Red Herring Prospectus and the Prospectus, which price will be equal to or higher than the Offer Price but not higher than the Cap Price. The Anchor Investor Offer Price will be decided by our Company and the Investor Selling Shareholders in consultation with the BRLMs.
Anchor Investor Pay-in Date	With respect to Anchor Investor(s), it shall be the Anchor Investor Bidding Date, and in the event the Anchor Investor Allocation Price is lower than the Offer Price, not later than two Working Days after the Bid/ Offer Closing Date.
Anchor Investor Portion	Up to 60% of the QIB Portion which may be allocated by our Company and the Investor Selling Shareholders in consultation with the BRLMs, to Anchor Investors and the basis of such allocation will be on a discretionary basis by the Company and the Investor Selling Shareholders, in consultation with the BRLMs, in accordance with the SEBI ICDR Regulations. One-third of the Anchor Investor Portion shall be reserved for domestic Mutual Funds, subject to valid Bids being received from domestic Mutual Funds at or above the Anchor Investor Allocation Price.
Anchor Investor(s)	A Qualified Institutional Buyer, applying under the Anchor Investor Portion in accordance with SEBI ICDR Regulations and the Red Herring Prospectus, and who has Bid for an amount of at least ₹100 million.
ASBA Account	A bank account maintained with an SCSB by an ASBA Bidder, as specified in the ASBA Form submitted by ASBA Bidders for blocking the Bid Amount mentioned in the relevant ASBA Form and includes the account of a UPI Bidder which is blocked upon acceptance of a UPI Mandate Request made by the UPI Bidder using the UPI Mechanism.
ASBA Bid	A Bid made by an ASBA Bidder.
ASBA Bidders	All Bidders except Anchor Investors
ASBA Form	An application form, whether physical or electronic, used by ASBA Bidders to submit Bids, which will be considered as the application for Allotment in terms of the Red Herring Prospectus and the Prospectus.

<b>Term</b>	<b>Description</b>
ASBA or Application Supported by Blocked Amount	An application, whether physical or electronic, used by ASBA Bidders, to make a Bid and authorising an SCSB to block the Bid Amount in the relevant ASBA Account and will include applications made by UPI Bidders using the UPI Mechanism where the Bid Amount will be blocked upon acceptance of UPI Mandate Request by the UPI Bidders using the UPI Mechanism.
Axis	Axis Capital Limited
Banker(s) to the Offer	Collectively, the Escrow Collection Bank, the Refund Bank, the Public Offer Account Bank and the Sponsor Banks.
Basis of Allotment	Basis on which Equity Shares will be Allotted to successful Bidders under the Offer, described in “ <i>Offer Procedure</i> ” on page 417.
Bid Amount	The highest value of optional Bids indicated in the Bid cum Application Form, and payable by the Bidder or blocked in the ASBA Account of the ASBA Bidder, as the case may be, upon submission of the Bid in the Offer, as applicable. In the case of Retail Individual Investors Bidding at the Cut off Price, the Cap Price multiplied by the number of Equity Shares Bid for by such Retail Individual Investors and mentioned in the Bid cum Application Form.
Bid cum Application Form	The Anchor Investor Application Form or the ASBA Form, as the context requires.
Bid Lot	[●] Equity Shares and in multiples of [●] Equity Shares thereafter.
Bid(s)	An indication by an ASBA Bidder to make an offer during the Bid/Offer Period pursuant to submission of the ASBA Form, or on the Anchor Investor Bidding Date by an Anchor Investor, pursuant to the submission of the Anchor Investor Application Form, to subscribe to or purchase Equity Shares at a price within the Price Band, including all revisions and modifications thereto, to the extent permissible under the SEBI ICDR Regulations, in terms of the Red Herring Prospectus and the Bid cum Application Form. The term ‘Bidding’ shall be construed accordingly.
Bid/ Offer Closing Date	Except in relation to any Bids received from the Anchor Investors, the date after which the Designated Intermediaries will not accept any Bids, which shall be notified in all editions of [●] (a widely circulated English national daily newspaper), all editions of [●] (a widely circulated Hindi national daily newspaper, Hindi also being the regional language of New Delhi, where our Registered Office is located), and in case of any revision, the extended Bid/Offer Closing Date shall also be widely disseminated by notification to the Stock Exchanges by issuing a press release and also by indicating the change on the website of the BRLMs and at the terminals of the Members of the Syndicate and by intimation to Designated Intermediaries and Sponsor Bank, as required under the SEBI ICDR Regulations. Our Company and the Investor Selling Shareholders in consultation with the BRLMs, may consider closing the Bid/Offer Period for QIBs one Working Day prior to the Bid/Offer Closing Date, in accordance with the SEBI ICDR Regulations.
Bid/ Offer Opening Date	Except in relation to any Bids received from the Anchor Investors, the date on which the Designated Intermediaries shall start accepting Bids, which shall be notified in all editions of [●] (a widely circulated English national daily newspaper) and all editions of [●] (a widely circulated Hindi national daily newspaper, Hindi also being the regional language of New Delhi, where our Registered Office is located), and in case of any revision, the extended Bid/ Offer Opening Date also be widely disseminated by notification to the Stock Exchanges by issuing a press release and also by indicating the change on the website of the BRLMs and at the terminals of the Members of the Syndicate and by intimation to Designated Intermediaries and Sponsor Banks, as required under the SEBI ICDR Regulations.
Bid/ Offer Period	Except in relation to Anchor Investors, the period between the Bid/ Offer Opening Date and the Bid/ Offer Closing Date, inclusive of both days, during which Bidders (excluding Anchor Investors) can submit their Bids, including any revisions thereof in accordance with the SEBI ICDR Regulations and the terms of the Red Herring Prospectus. Our Company and the Investor Selling Shareholders, in consultation with the BRLMs, may consider closing the Bid/ Offer Period for QIBs one Working Day prior to the Bid/ Offer Closing Date, in accordance with the SEBI ICDR Regulations.
Bidder or Applicant	Any prospective investor who makes a Bid pursuant to the terms of the Red Herring Prospectus and the Bid cum Application Form and unless otherwise stated or implied, includes an ASBA Bidder and an Anchor Investor.
Bidding Centres	Centres at which the Designated Intermediaries shall accept the Bid cum Application Forms, <i>i.e.</i> , Designated SCSB Branches for SCSBs, Specified Locations for Members of the Syndicate, Broker Centres for Registered Brokers, Designated RTA Locations for RTAs and Designated CDP Locations for CDPs.
Book Building Process	Book building process, as provided in Part A of Schedule XIII of the SEBI ICDR Regulations, in terms of which the Offer is being made.
Book Running Lead Managers or	The book running lead managers to the Offer, being Axis, DAM Capital and JM

<b>Term</b>	<b>Description</b>
BRLMs	Financial.
Broker Centres	Broker centres notified by the Stock Exchanges where ASBA Bidders can submit the ASBA Forms to a Registered Broker. The details of such Broker Centres, along with the names and contact details of the Registered Brokers are available on the respective websites of the Stock Exchanges at <a href="http://www.bseindia.com">www.bseindia.com</a> and <a href="http://www.nseindia.com">www.nseindia.com</a> .
CAN or Confirmation of Allocation Note	Notice or intimation of allocation of the Equity Shares sent to Anchor Investors, who have been allocated the Equity Shares, on or after the Anchor Investor Bidding Date.
Cap Price	The higher end of the Price Band, above which the Offer Price and Anchor Investor Offer Price will not be finalised and above which no Bids will be accepted.
Cash Escrow and Sponsor Bank Agreement	The agreement to be entered into amongst our Company, the Selling Shareholders, the Syndicate Members, the Registrar to the Offer, the BRLMs, and the Banker(s) to the Offer for, among other things, collection of the Bid Amounts from the Anchor Investors, transfer of funds to the Public Offer Account, and where applicable, remitting refunds, if any, to such Bidders, on the terms and conditions thereof.
CDP or Collecting Depository Participant	A depository participant as defined under the Depositories Act, 1996, registered with SEBI and who is eligible to procure Bids at the Designated CDP Locations in terms of circular no. CIR/CFD/POLICYCELL/11/2015 dated November 10, 2015 issued by SEBI as per the lists available on the websites of the BSE and the NSE.
Client ID	Client identification number maintained with one of the Depositories in relation to the demat account.
CRISIL	CRISIL Limited
CRISIL Report	Report on 'Global market assessment of 3PL and PMP products in Agriculture and Construction Equipment' dated April, 2022 prepared by CRISIL Research, a division of CRISIL Limited, commissioned and paid for by our Company, a copy of which will be available on the website of our Company at <a href="http://www.unipartsgroup.com/ipo-industry-reports.asp?links=inv52">www.unipartsgroup.com/ipo-industry-reports.asp?links=inv52</a> from the date of the Red Herring Prospectus until the Bid/Offer Closing Date.
Cut-Off Price	Offer Price, which shall be any price within the Price Band, finalised by our Company and the Investor Selling Shareholders in consultation with the BRLMs. Only Retail Individual Investors are entitled to Bid at the Cut-off Price. QIBs (including Anchor Investors) and Non-Institutional Investors are not entitled to Bid at the Cut-off Price.
DAM Capital	DAM Capital Advisors Limited ( <i>Formerly IDFC Securities Limited</i> )
Demographic Details	The details of the Bidders including the Bidder's address, name of the Bidder's father/husband, investor status, occupation, bank account details and UPI ID, as applicable.
Designated CDP Locations	Such locations of the CDPs where Bidders can submit the ASBA Forms. The details of such Designated CDP Locations, along with names and contact details of the Collecting Depository Participants eligible to accept ASBA Forms are available on the respective websites of the Stock Exchanges ( <a href="http://www.bseindia.com">www.bseindia.com</a> and <a href="http://www.nseindia.com">www.nseindia.com</a> , respectively,) as updated from time to time.
Designated Date	The date on which the funds from the Escrow Account are transferred to the Public Offer Account or the Refund Account, as appropriate, and the relevant amounts blocked in the ASBA Accounts are transferred to the Public Offer Account(s) and/or are unblocked, as applicable, in terms of the Red Herring Prospectus and the Prospectus, after finalization of the Basis of Allotment in consultation with the Designated Stock Exchange, following which the Equity Shares will be Allotted in the Offer.
Designated Intermediary(ies)	In relation to ASBA Forms submitted by RIIs by authorising an SCSB to block the Bid Amount in the ASBA Account, Designated Intermediaries shall mean SCSBs.  In relation to ASBA Forms submitted by UPI Bidders where the Bid Amount will be blocked upon acceptance of UPI Mandate Request by such UPI Bidder using the UPI Mechanism, Designated Intermediaries shall mean Syndicate, sub-Syndicate/agents, Registered Brokers, CDPs, SCSBs and RTAs.  In relation to ASBA Forms submitted by QIBs and Non-Institutional Investors (not using the UPI Mechanism), Designated Intermediaries shall mean Syndicate, sub-Syndicate/ agents, SCSBs, Registered Brokers, the CDPs and RTAs.
Designated RTA Locations	Such locations of the RTAs where ASBA Bidders can submit the ASBA Forms to RTAs. The details of such Designated RTA Locations, along with names and contact details of the RTAs eligible to accept ASBA Forms are available on the respective websites of the Stock Exchanges ( <a href="http://www.bseindia.com">www.bseindia.com</a> and <a href="http://www.nseindia.com">www.nseindia.com</a> , respectively,) as updated from time to time.
Designated SCSB Branches	Such branches of the SCSBs which shall collect the ASBA Forms used by the Bidders,



Term	Description
	a list of which is available on the website of SEBI at <a href="http://www.sebi.gov.in/sebiweb/other/OtherAction.do?doRecognisedFpi=yes&amp;intmId=35">http://www.sebi.gov.in/sebiweb/other/OtherAction.do?doRecognisedFpi=yes&amp;intmId=35</a> , updated from time to time, or at such other website as may be prescribed by SEBI from time to time.
Designated Stock Exchange	[●]
Draft Red Herring Prospectus or DRHP	This draft red herring prospectus dated April 25, 2022 issued in accordance with the SEBI ICDR Regulations, which does not contain complete particulars of the price at which the Equity Shares will be Allotted and the size of the Offer, including any addenda or corrigenda thereto.
Eligible FPI	FPIs(s) that are eligible to participate in this Offer in terms of applicable laws, other than individuals, corporate bodies and family offices.
Eligible NRI	NRI(s) from jurisdictions outside India where it is not unlawful to make an offer or invitation under the Offer and in relation to whom the Bid Cum Application Form and the Red Herring Prospectus will constitute an invitation to purchase the Equity Shares.
Escrow Account(s)	Account(s) opened with the Escrow Collection Bank and in whose favour Anchor Investors will transfer the money through direct credit/NEFT/RTGS/NACH in respect of the Bid Amount while submitting a Bid.
Escrow Collection Bank	Bank which is a clearing member and registered with SEBI as a banker to an issue under the Securities and Exchange Board of India (Bankers to an Issue) Regulations, 1994, and with whom the Escrow Account(s) will be opened, in this case being [●].
First or sole Bidder	The Bidder whose name shall be mentioned in the Bid cum Application Form or the Revision Form and in case of joint Bids, whose name shall also appear as the first holder of the beneficiary account held in joint names.
Floor Price	The lower end of the Price Band, subject to any revision thereto, at or above which the Offer Price and the Anchor Investor Offer Price will be finalised and below which no Bids will be accepted.
Fraudulent Borrower	Fraudulent borrower as defined under Regulation 2(1)(III) of the SEBI ICDR Regulations.
General Information Document or GID	The General Information Document for investing in public offers, prepared and issued in accordance with the circular (SEBI/HO/CFD/DIL1/CIR/P/2020/37) dated March 17, 2020 issued by SEBI and the UPI Circulars, as amended from time to time. The General Information Document shall be available on the websites of the Stock Exchanges and the BRLMs.
JM Financial	JM Financial Limited
Materiality Policy	Policy for identification of material group companies, material outstanding civil litigation proceedings of our Company, Subsidiaries, our Promoters and our Directors and material creditors of the Company, pursuant to the disclosure requirements under SEBI ICDR Regulations, as adopted by the Board through its resolution dated March 22, 2022.
Mutual Fund Portion	The portion of the Offer being 5% of the Net QIB Portion consisting of 157,319 Equity Shares which shall be available for allocation to Mutual Funds only on a proportionate basis, subject to valid Bids being received at or above the Offer Price.
Mutual Funds	Mutual funds registered with SEBI under the Securities and Exchange Board of India (Mutual Funds) Regulations, 1996.
NBFC-SI	A systemically important non-banking financial company as defined under Regulation 2(1)(iii) of the SEBI ICDR Regulations.
Net Proceeds	Proceeds of the Offer less Offer expenses.
Net QIB Portion	The portion of the QIB Portion less the number of Equity Shares Allotted to the Anchor Investors.
Non-Institutional Bidders or Non-Institutional Investors or NIIs	Bidders that are not QIBs or RIIs and who have Bid for Equity Shares for an amount more than ₹200,000 (but not including NRIs other than Eligible NRIs).
Non-Institutional Category	The portion of the Offer being not less than 15% of the Offer consisting of 2,359,792 Equity Shares, available for allocation to Non-Institutional Investors, of which one-third shall be available for allocation to Bidders with an application size of more than ₹ 200,000 and up to ₹ 1,000,000 and two-thirds shall be available for allocation to Bidders with an application size of more than ₹ 1,000,000, provided that the unsubscribed portion in either of such sub-categories may be allocated to applicants in the other sub-category of Non-Institutional Investors subject to valid Bids being received at or above the Offer Price.
Non-Resident	Person resident outside India, as defined under FEMA and includes non-resident Indians, FVCIs and FPIs.
Offer	The initial public offer of Equity Shares comprising the Offer for Sale.
Offer Agreement	The agreement dated April 25, 2022 among our Company, the Selling Shareholders and the BRLMs, pursuant to which certain arrangements are agreed to in relation to the Offer.

Term	Description
Offer for Sale	The Offer for Sale comprising of up to 1,700,000 Equity Shares by the Karan Soni 2018 CG-NG Nevada Trust aggregating up to ₹ [●] million, up to 1,700,000 Equity Shares by the Meher Soni 2018 CG-NG Nevada Trust aggregating up to ₹ [●] million and up to 2,250,000 Equity Shares by Pamela Soni aggregating up to ₹ [●] million, up to 2,154,192 Equity Shares by Ambadevi aggregating up to ₹ [●] million and up to 7,180,642 Equity Shares by Ashoka aggregating up to ₹ [●] million, up to 177,378 Equity Shares by Andrew Warren Code aggregating up to ₹ [●] million, up to 177,378 Equity Shares by James Norman Hallene aggregating up to ₹ [●] million, up to 177,378 Equity Shares by Kevin John Code aggregating up to ₹ [●] million, up to 57,420 Equity Shares by Dennis Francis DeDecker aggregating up to ₹ [●] million, up to 41,730 Equity Shares by Melvin Keith Gibbs aggregating up to ₹ [●] million, up to 24,706 Equity Shares by Walter James Gruber aggregating up to ₹ [●] million, up to 21,556 Equity Shares by Wendy Reichard Hammen aggregating up to ₹ [●] million, up to 20,870 Equity Shares by Mark Louis Dawson aggregating up to ₹ [●] million, up to 16,366 Equity Shares by Bradley Lorenz Miller aggregating up to ₹ [●] million, up to 10,440 Equity Shares by Mary Louise Arp aggregating up to ₹ [●] million, up to 8,340 Equity Shares by Diana Lynn Craig aggregating up to ₹ [●] million, up to 7,710 Equity Shares by Marc Christopher Dorau aggregating up to ₹ [●] million, up to 5,010 Equity Shares by Craig A Johnson aggregating up to ₹ [●] million and up to 826 Equity Shares by Misty Marie Garcia aggregating up to ₹ [●] million. For further information, see “ <i>The Offer</i> ” on page 76.
Offer Price	The final price at which Equity Shares will be Allotted to successful ASBA Bidders in terms of the Red Herring Prospectus which will be decided by our Company and the Investor Selling Shareholders in consultation with the BRLMs on the Pricing Date, in accordance with the Book-Building Process and in terms of the Red Herring Prospectus. Equity Shares will be Allotted to Anchor Investors at the Anchor Investor Offer Price, which will be decided by our Company and the Investor Selling Shareholders in consultation with the BRLMs on the Pricing Date, in accordance with the Book-Building Process and in terms of the Red Herring Prospectus.
Offer Proceeds	Our Company will not receive any proceeds from the Offer.
Offered Shares	Up to 15,731,942 Equity Shares aggregating to ₹ [●] million being offered for sale by the Selling Shareholders in the Offer.
Price Band	The price band ranging from the Floor Price of ₹ [●] per Equity Share to the Cap Price of ₹ [●] per Equity Share, including any revisions thereof. The Price Band and minimum Bid Lot, as decided by our Company and the Investor Selling Shareholders, in consultation with the BRLMs will be advertised in all editions of [●] (a widely circulated English national daily newspaper) and all editions of [●] (a widely circulated Hindi national daily newspaper, Hindi also being the regional language of New Delhi, where our Registered Office is located), at least two Working Days prior to the Bid/ Offer Opening Date with the relevant financial ratios calculated at the Floor Price and at the Cap Price, and shall be made available to the Stock Exchanges for the purpose of uploading on their respective websites.
Pricing Date	The date on which our Company and the Investor Selling Shareholders in consultation with the BRLMs, will finalise the Offer Price.
Prospectus	The Prospectus to be filed with the RoC on or after the Pricing Date in accordance with Section 26 of the Companies Act, 2013, and the SEBI ICDR Regulations containing, <i>inter alia</i> , the Offer Price, the size of the Offer and certain other information, including any addenda or corrigenda thereto.
Public Offer Account	The bank account opened with the Public Offer Account Bank under Section 40(3) of the Companies Act, 2013, to receive monies from the Escrow Account and from the ASBA Accounts on the Designated Date.
Public Offer Account Bank	Bank which is a clearing member and registered with SEBI as a banker to an issue, and with whom the Public Offer Account(s) will be opened.
QIB Bid/ Offer Closing Date	In the event our Company and the Investor Selling Shareholders in consultation with the BRLMs, decide to close Bidding by QIBs one day prior to the Bid/Offer Closing Date, the date one day prior to the Bid/Offer Closing Date; otherwise it shall be the same as the Bid/Offer Closing Date.
QIB Bidders	QIBs who Bid in the Offer.
QIB Portion	The portion of the Offer being not more than 50% of the Offer or 7,865,970 Equity Shares, available for allocation to QIBs (including Anchor Investors) on a proportionate basis (in which allocation to Anchor Investors shall be on a discretionary basis, as determined by our Company and the Investor Selling Shareholders in consultation with the BRLMs), subject to valid Bids being received at or above the Offer Price.
QIBs or Qualified Institutional Buyers	Qualified institutional buyers as defined under Regulation 2(1)(ss) of the SEBI ICDR Regulations.

<b>Term</b>	<b>Description</b>
Red Herring Prospectus or RHP	The Red Herring Prospectus to be issued in accordance with Section 32 of the Companies Act, 2013, and the provisions of the SEBI ICDR Regulations, which will not have complete particulars of the price at which the Equity Shares will be offered and the size of the Offer, including any addenda or corrigenda thereto. The Red Herring Prospectus will be filed with the RoC at least three days before the Bid/ Offer Opening Date and will become the Prospectus upon filing with the RoC after the Pricing Date.
Refund Account	The account opened with the Refund Bank(s), from which refunds, if any, of the whole or part of the Bid Amount to Anchor Investors shall be made.
Refund Bank	The Banker to the Offer with whom the Refund Account(s) will be opened, in this case being [●].
Registered Brokers	Stock brokers registered with SEBI under the Securities and Exchange Board of India (Stock Brokers) Regulations, 1992 and the stock exchanges having nationwide terminals, other than the Members of the Syndicate and eligible to procure Bids in terms of Circular No. CIR/CFD/14/2012 dated October 4, 2012, issued by SEBI.
Registrar Agreement	The agreement dated April 25, 2022 entered into between our Company, the Selling Shareholders and the Registrar to the Offer, in relation to the responsibilities and obligations of the Registrar to the Offer pertaining to the Offer.
Registrar to the Offer or Registrar	Link Intime India Private Limited.
Resident Indian	A person resident in India, as defined under FEMA.
Retail Individual Bidder(s) or Retail Individual Investor(s) or RII(s) or RIB(s)	Individual Bidders, who have Bid for the Equity Shares for an amount which is not more than ₹200,000 in any of the bidding options in the Offer (including HUFs applying through their Karta and Eligible NRI Bidders) and does not include NRIs (other than Eligible NRIs).
Retail Portion or Retail Category	The portion of the Offer being not less than 35% of the Offer consisting of 5,506,180 Equity Shares, available for allocation to Retail Individual Bidders as per the SEBI ICDR Regulations, subject to valid Bids being received at or above the Offer Price.
Revision Form	Form used by the Bidders to modify the quantity of the Equity Shares or the Bid Amount in any of their Bid cum Application Forms or any previous Revision Form(s), as applicable.  QIB Bidders and Non-Institutional Investors are not allowed to withdraw or lower their Bids (in terms of quantity of Equity Shares or the Bid Amount) at any stage. Retail Individual Bidders can revise their Bids during the Bid/ Offer Period and withdraw their Bids until the Bid/ Offer Closing Date.
RTAs or Registrar and Share Transfer Agents	The registrar and share transfer agents registered with SEBI and eligible to procure Bids at the Designated RTA Locations as per the list available on the websites of BSE and NSE, and the UPI Circulars.
Self Certified Syndicate Bank(s) or SCSB(s)	The banks registered with SEBI, offering services in relation to ASBA (other than through UPI Mechanism), a list of which is available on the website of SEBI at <a href="http://www.sebi.gov.in/sebiweb/other/OtherAction.do?doRecognisedFpi=yes&amp;intmId=34">www.sebi.gov.in/sebiweb/other/OtherAction.do?doRecognisedFpi=yes&amp;intmId=34</a> or <a href="http://www.sebi.gov.in/sebiweb/other/OtherAction.do?doRecognisedFpi=yes&amp;intmId=35">www.sebi.gov.in/sebiweb/other/OtherAction.do?doRecognisedFpi=yes&amp;intmId=35</a> , as applicable, or such other website as updated from time to time, and (ii) The banks registered with SEBI, enabled for UPI Mechanism, a list of which is available on the website of SEBI at <a href="http://www.sebi.gov.in/sebiweb/other/OtherAction.do?doRecognisedFpi=yes&amp;intmId=40">www.sebi.gov.in/sebiweb/other/OtherAction.do?doRecognisedFpi=yes&amp;intmId=40</a>  Applications through UPI in the Offer can be made only through the SCSBs mobile applications (apps) whose name appears on SEBI website. A list of SCSBs and mobile application, which, are live for applying in public issues using UPI Mechanism is appearing in the “list of mobile applications for using UPI in public issues” displayed on SEBI website at <a href="http://www.sebi.gov.in/sebiweb/other/OtherAction.do?doRecognisedFpi=yes&amp;intmId=43">www.sebi.gov.in/sebiweb/other/OtherAction.do?doRecognisedFpi=yes&amp;intmId=43</a> . The said list shall be updated on SEBI website.
Share Escrow Agent	The share escrow agent to be appointed pursuant to the Share Escrow Agreement.
Share Escrow Agreement	The agreement to be entered into between our Company, the Selling Shareholders and the Share Escrow Agent in connection with the transfer of the Offered Shares by the Selling Shareholders and credit of such Equity Shares to the demat account of the Allottees in accordance with the Basis of Allotment.
Specified Locations	Bidding centres where the Syndicate shall accept ASBA Forms from Bidders.
Sponsor Bank(s)	[●], being Bankers to the Offer, appointed by the Company to act as a conduit between the Stock Exchanges and the NPCI in order to push the mandate collect requests and / or payment instructions of UPI Bidders using the UPI Mechanism and carry out other responsibilities, in terms of the UPI Circulars.
Sub-Syndicate Members	The sub-syndicate members, if any, appointed by the BRLMs and the Syndicate

<b>Term</b>	<b>Description</b>
	Members, to collect ASBA Forms and Revision Forms.
Syndicate Agreement	The agreement to be entered into between our Company, the Registrar to the Offer, the Selling Shareholders, the BRLMs and the Syndicate Members in relation to the procurement of Bid cum Application Forms by the Syndicate.
Syndicate Members	Syndicate members as defined under Regulation 2(1)(hhh) of the SEBI ICDR Regulations.
Syndicate or Members of the Syndicate	The BRLMs and the Syndicate Members.
Underwriters	[•]
Underwriting Agreement	The agreement to be entered into between the Underwriters, our Company and the Selling Shareholders, entered into on or after the Pricing Date but prior to filing of the Prospectus with the RoC.
UPI	Unified Payments Interface which is an instant payment mechanism, developed by NPCI.
UPI Bidders	Collectively, individual investors applying as Retail Individual Investors in the Retail Portion, and individuals applying as Non-Institutional Investors with a Bid Amount of up to ₹ 500,000 in the Non-Institutional Portion.  Pursuant to SEBI circular no. SEBI/HO/CFD/DIL2/P/CIR/P/2022/45 dated April 5, 2022, all individual investors applying in public issues where the application amount is up to ₹ 500,000 shall use UPI and shall provide their UPI ID in the bid-cum-application form submitted with: (i) a syndicate member, (ii) a stock broker registered with a recognized stock exchange (whose name is mentioned on the website of the stock exchange as eligible for such activity), (iii) a depository participant (whose name is mentioned on the website of the stock exchange as eligible for such activity), and (iv) a registrar to an issue and share transfer agent (whose name is mentioned on the website of the stock exchange as eligible for such activity).
UPI Circulars	SEBI circular number SEBI/HO/CFD/DIL2/CIR/P/2018/138 dated November 1, 2018, SEBI circular number SEBI/HO/CFD/DIL2/CIR/P/2019/50 dated April 3, 2019, SEBI circular number SEBI/HO/CFD/DIL2/CIR/P/2019/76 dated June 28, 2019, SEBI circular number SEBI/HO/CFD/DIL2/CIR/P/2019/85 dated July 26, 2019, SEBI circular number SEBI/HO/CFD/DCR2/CIR/P/2019/133 dated November 8, 2019, SEBI circular number SEBI/HO/CFD/DIL2/CIR/P/2020 dated March 30, 2020, SEBI circular number SEBI/HO/CFD/DIL2/CIR/P/2021/2480/1/M dated March 16, 2021, SEBI circular number SEBI/HO/CFD/DIL1/CIR/P/2021/47 dated March 31, 2021, SEBI circular number SEBI/HO/CFD/DIL2/P/CIR/2021/570 dated June 2, 2021, SEBI circular no. SEBI/HO/CFD/DIL2/P/CIR/P/2022/45 dated April 5, 2022, SEBI circular no. SEBI/HO/CFD/DIL2/CIR/P/2022/51 dated April 20, 2022 and any subsequent circulars or notifications issued by SEBI in this regard.
UPI ID	ID created on Unified Payment Interface (UPI) for single-window mobile payment system developed by the National Payments Corporation of India (NPCI).
UPI Mandate Request	A request (intimating the UPI Bidder by way of a notification on the UPI application, by way of a SMS directing the UPI Bidder to such UPI application) to the UPI Bidder initiated by the Sponsor Bank to authorise blocking of funds on the UPI application equivalent to Bid Amount and subsequent debit of funds in case of Allotment.
UPI Mechanism	The bidding mechanism that shall be used by a UPI Bidder to make an ASBA Bid in the Offer in accordance with the UPI Circulars.
UPI PIN	Password to authenticate UPI transaction.
Wilful Defaulter	Wilful defaulter as defined under Regulation 2(1)(lll) of the SEBI ICDR Regulations.
Working Day	All days on which commercial banks in Mumbai are open for business; provided, however, with reference to (a) announcement of Price Band; and (b) Bid/ Offer Period, the expression “Working Day” shall mean all days on which commercial banks in Mumbai are open for business, excluding all Saturdays, Sundays or public holidays; and (c) with reference to the time period between the Bid/ Offer Closing Date and the listing of the Equity Shares on the Stock Exchanges, the expression ‘Working Day’ shall mean all trading days of Stock Exchanges, excluding Sundays and bank holidays, in terms of the circulars issued by SEBI.

#### Technical/ Industry Related Terms/ Abbreviations

<b>Term</b>	<b>Description</b>
3PL	3-Point Linkage systems
4WD	4 Wheel Drive
Bobcat	Doosan Bobcat North America

<b>Term</b>	<b>Description</b>
CFM	Construction, forestry and mining
Claas Tractors	Claas Agricultural Machinery Private Limited
CNC	Computer numerical control
Direct Exports	Export sales from Indian locations directly to overseas customers
ED	Electrophoretic deposition
EDPMS	Export Data Processing Monitoring System
EEPC	Engineering Export Promotion Council
EPCG	Export Promotion Capital Goods
ERP	Enterprise resource planning
FIFO	First-in-first-out
GCF	Gas Carburizing Furnace
HP	Horsepower
International Sales	Sales in regions outside India
ISO	International Organization for Standardization
John Deere	Deere & Company
Kobleco	Kobelco Construction Equipment India Private Limited
Kubota	Kubota Manufacturing of America Corporation
Local Deliveries	Sales from our manufacturing facilities in their respective domestic markets
MEIS	Merchandise Exports from India Scheme
OEM(s)	Original equipment manufacturer(s)
OHVs	Off-highway vehicles
PMP	Precision machined parts
PTO	Power take off
RoAE	Return on Average Equity
Rpm	Revolutions per minute
ROCE	Return on Capital Employed
SEZ	Special Economic Zone
SKU	Stock-keeping unit
TAFE	Tractors and Farm Equipment Limited
TSC	Tractor Supply Company
VMC	Vertical machining center
Warehouse Sales	Sales from warehousing facilities in their respective domestic markets
Yanmar	Yanmar Global Expert Co., Ltd

### Conventional and General Terms or Abbreviations

<b>Term</b>	<b>Description</b>
₹ or Rs. or INR or Rupees	Indian Rupees.
AGM	Annual General Meeting.
AIF	An alternative investment fund as defined in and registered with SEBI under the SEBI AIF Regulations.
AS or Accounting Standards	Accounting standards as prescribed by Section 133 of the Companies Act, 2013 read with Rule 7 of the Companies (Accounts) Rules, 2014.
BSE	BSE Limited.
Category I AIF	AIFs registered as “Category I Alternative Investment Funds” under the SEBI AIF Regulations.
Category I FPI	FPIs registered as “Category I foreign portfolio investors” under the SEBI FPI Regulations.
Category II AIF	AIFs registered as “Category II Alternative Investment Funds” under the SEBI AIF Regulations.
Category II FPI	FPIs registered as “Category II foreign portfolio investors” under the SEBI FPI Regulations.
Category III AIF	AIFs registered as “Category III Alternative Investment Funds” under the SEBI AIF Regulations.
CDSL	Central Depository Services (India) Limited.
CIN	Corporate Identity Number.
CIT	Commissioner of Income Tax.
Companies Act	Companies Act, 1956 and Companies Act, 2013, as applicable.
Companies Act, 1956	The erstwhile Companies Act, 1956 along with the relevant rules made thereunder.
Companies Act, 2013	Companies Act, 2013, along with the relevant rules, regulations, clarifications, circulars and notifications issued thereunder, as amended to the extent currently in force.
CSR	Corporate Social Responsibility.

<b>Term</b>	<b>Description</b>
Depositories	Together, NSDL and CDSL.
Depositories Act	The Depositories Act, 1996, read with regulations framed thereunder.
DIN	Director Identification Number.
DP ID	Depository Participant's Identity Number.
DP or Depository Participant	A depository participant as defined under the Depositories Act.
DPIIT	Department for Promotion of Industry and Internal Trade, Ministry of Commerce and Industry, Government of India (formerly known as Department of Industrial Policy and Promotion).
EBITDA	Earnings before interest, taxes, depreciation and amortisation.
EGM	Extraordinary General Meeting.
EPS	Earnings Per Share.
FAQs	Frequently asked questions.
FCNR	Foreign currency non-resident account.
FDI	Foreign Direct Investment.
FDI Circular	The consolidated FDI Policy, issued by the Department of Promotion of Industry and Internal Trade, Ministry of Commerce and Industry, Government of India, and any modifications thereto or substitutions thereof, effective from October 15, 2020.
FIR	First information report
FEMA	Foreign Exchange Management Act, 1999, read with rules and regulations thereunder.
FEMA Rules	Foreign Exchange Management (Non-debt Instruments) Rules, 2019
Financial Year or Fiscal or Fiscal Year or FY	The period of 12 months commencing on April 1 of the immediately preceding calendar year and ending on March 31 of that particular calendar year.
FPI(s)	Foreign portfolio investors as defined under the SEBI FPI Regulations.
FVCI	Foreign venture capital investors as defined and registered under the SEBI FVCI Regulations.
Fugitive Economic Offender	A fugitive economic offender as defined under the Fugitive Economic Offenders Act, 2018
GDP	Gross domestic product.
GoI or Government or Central Government	The Government of India.
GST	Goods and services tax.
Hazardous Waste Rules	Hazardous and Other Wastes (Management and Transboundary Movement) Rules, 2016.
HUF	Hindu undivided family.
ICAI	The Institute of Chartered Accountants of India.
IFRS	International Financial Reporting Standards of the International Accounting Standards Board.
Income Tax Act	Income Tax Act, 1961.
Ind AS	Indian Accounting Standards prescribed under section 133 of the Companies Act, 2013, as notified under Companies (Indian Accounting Standard) Rules, 2015.
India	Republic of India.
Indian GAAP	Accounting standards notified under section 133 of the Companies Act, 2013, read with Companies (Accounting Standards) Rules, 2006 and the Companies (Accounts) Rules, 2014.
Insider Trading Regulations	Securities and Exchange Board of India (Prohibition of Insider Trading) Regulations, 2015
IPO	Initial public offering.
IRDAI	Insurance Regulatory and Development Authority of India.
IST	Indian Standard Time.
IT Act	The Information Technology Act, 2000.
MCA	Ministry of Corporate Affairs, Government of India.
N.A. or NA	Not applicable.
NACH	National Automated Clearing House.
National Investment Fund	National Investment Fund set up by resolution F. No. 2/3/2005-DD-II dated November 23, 2005 of the GoI, published in the Gazette of India.
NAV	Net asset value (per Equity Share) means total equity, as restated divided by number of Equity Shares outstanding at the end of the year/ period.
NEFT	National Electronic Fund Transfer.
NPCI	National Payments Corporation of India.
NRE	Non-Resident External.
NRE Account	Non-Resident External account.
NRI	A person resident outside India, who is a citizen of India or an overseas citizen of India cardholder within the meaning of section 7(A) of the Citizenship Act, 1955.
NRO	Non-Resident Ordinary.

<b>Term</b>	<b>Description</b>
NSDL	National Securities Depository Limited.
NSE	National Stock Exchange of India Limited.
OCB or Overseas Corporate Body	A company, partnership, society or other corporate body owned directly or indirectly to the extent of at least 60% by NRIs including overseas trusts, in which not less than 60% of beneficial interest is irrevocably held by NRIs directly or indirectly and which was in existence on October 3, 2003 and immediately before such date was eligible to undertake transactions pursuant to general permission granted to OCBs under FEMA. OCBs are not allowed to invest in the Offer.
p.a.	Per annum.
P/E Ratio	Price/earnings ratio.
PAN	Permanent account number.
PAT	Profit after tax.
RBI	Reserve Bank of India.
Regulation S	Regulation S under the U.S. Securities Act.
RoNW	Return on Net Worth.
RTGS	Real time gross settlement.
Rule 144A	Rule 144A under the U.S. Securities Act.
SCRA	Securities Contracts (Regulation) Act, 1956.
SCRR	Securities Contracts (Regulation) Rules, 1957.
SEBI	Securities and Exchange Board of India constituted under the SEBI Act, 1992.
SEBI Act	Securities and Exchange Board of India Act, 1992.
SEBI AIF Regulations	Securities and Exchange Board of India (Alternative Investment Funds) Regulations, 2012.
SEBI FPI Regulations	Securities and Exchange Board of India (Foreign Portfolio Investors) Regulations, 2019.
SEBI FVCI Regulations	Securities and Exchange Board of India (Foreign Venture Capital Investors) Regulations, 2000.
SEBI ICDR Regulations	Securities and Exchange Board of India (Issue of Capital and Disclosure Requirements) Regulations, 2018.
SEBI Listing Regulations	Securities and Exchange Board of India (Listing Obligations and Disclosure Requirements) Regulations, 2015.
SEBI SBEB & SE Regulations	Securities and Exchange Board of India (Share Based Employee Benefits and Sweat Equity) Regulations, 2021.
SEBI VCF Regulations	Securities and Exchange Board of India (Venture Capital Fund) Regulations, 1996.
State Government	The government of a state in India.
Stock Exchanges	Collectively, the BSE and NSE.
STT	Securities transaction tax.
Takeover Regulations	Securities and Exchange Board of India (Substantial Acquisition of Shares and Takeovers) Regulations, 2011.
Trademarks Act	Trade Marks Act, 1999.
TAN	Tax deduction account number.
TDS	Tax deducted at source.
U.S. GAAP	Generally accepted accounting principles of the United States of America.
U.S. Securities Act	U.S. Securities Act of 1933, as amended.
US or USA or United States	United States of America.
USD or US\$	United States Dollars.
VAT	Value added tax.
VCFs	Venture capital funds as defined in and registered with SEBI under SEBI VCF Regulations.
WACoA	Weighted average cost of acquisition.
Year or Calendar Year	The 12 month period ending December 31.

## CERTAIN CONVENTIONS, USE OF FINANCIAL INFORMATION AND MARKET DATA AND CURRENCY OF PRESENTATION

### Certain Conventions

All references in this Draft Red Herring Prospectus to ‘India’ are to the Republic of India and its territories and possessions and all references herein to the ‘Government’, ‘Indian Government’, ‘GoI’, ‘Central Government’ or the ‘State Government’ are to the Government of India, central or state, as applicable.

### Page Numbers

Unless otherwise stated, all references to page numbers in this Draft Red Herring Prospectus are to page numbers of this Draft Red Herring Prospectus.

### Currency and Units of Presentation

All references to “*Rupee(s)*”, “*Rs.*” or “*₹*” or “*INR*” are to Indian Rupees, the official currency of the Republic of India. All references to “*US\$*” or “*U.S. Dollars*” or “*USD*” are to United States Dollars, the official currency of the United States of America. All references to “*EUR*” or “*€*” are to Euro, the official currency of the European Union.

### Exchange Rates

This Draft Red Herring Prospectus contains conversions of certain other currency amounts into Rupees that have been presented solely to comply with the requirements of SEBI ICDR Regulations. Unless otherwise stated, the exchange rates referred to for the purpose of conversion of foreign currency amounts into Rupee amounts, are as follows:

Currency	Exchange rate as on			
	December 31, 2021	March 31, 2021	March 31, 2020	March 31, 2019*
USD	74.30	73.50	75.39	69.17
Euro	84.05	86.10	83.05	77.70

Source: FBIL Reference Rate as available on <https://www.fbil.org.in/>

\* If the exchange rate is not available on a particular date due to a public holiday, exchange rates of the previous working day have been disclosed.

Such conversion should not be considered as a representation that such currency amounts have been, could have been or can be converted into Rupees at any particular rate, the rates stated above or at all.

### Time

All references to time in this Draft Red Herring Prospectus are to IST.

### Financial and Other Data

Unless stated or the context requires otherwise, the financial information in this Draft Red Herring Prospectus is derived from our Restated Financial Statements.

The Restated Financial Statements of our Company, comprise the summary statement of assets and liabilities for the nine months period ended December 31, 2021 and for the years ended March 31, 2021, March 31, 2020 and March 31, 2019, the restated summary statements of profit and loss (including other comprehensive income), the restated summary statement of changes in equity and the restated summary statement of cash flows for the nine months period ended December 31, 2021 and for the years ended March 31, 2021, March 31, 2020 and March 31, 2019, together with the summary statement of significant accounting policies, and other explanatory information, each by the Company in accordance with the requirements of Section 26 of Part I of Chapter III of the Companies Act, 2013, relevant provisions of the SEBI ICDR Regulations, and the Guidance Note on Reports on Company Prospectuses (Revised 2019) issued by the ICAI, as amended from time to time.

For further information on our Company’s financial information, see “*Financial Statements*” and “*Management’s Discussion and Analysis of Financial Condition and Results of Operations*” on pages 212 and 355, respectively.



Our Company's fiscal year commences on April 1 of each year and ends on March 31 of the next year. Accordingly, all references to a particular fiscal year (referred to herein as "**Fiscal**", "**Fiscal Year**" or "**FY**") are to the 12-month period ended March 31 of that particular year, unless otherwise specified.

All the figures in this Draft Red Herring Prospectus have been presented in million or in whole numbers where the numbers have been too small to present in million unless stated otherwise. One million represents 1,000,000 and one billion represents 1,000,000,000. Certain figures contained in this Draft Red Herring Prospectus, including financial information, have been subject to rounding adjustments. Any discrepancies in any table between the totals and the sum of the amounts listed are due to rounding off. All figures in decimals have been rounded off to the two decimal points. In certain instances, (i) the sum or percentage change of such numbers may not conform exactly to the total figure given, and (ii) the sum of the figures in a column or row in certain tables may not conform exactly to the total figure given for that column or row. However, figures sourced from third-party industry sources may be expressed in denominations other than million or may be rounded off to other than two decimal points in the respective sources, and such figures have been expressed in this Draft Red Herring Prospectus in such denominations or rounded-off to such number of decimal points as provided in such respective sources.

Unless the context otherwise indicates, any percentage amounts, as set forth in "**Risk Factors**", "**Our Business**" and "**Management's Discussion and Analysis of Financial Condition and Results of Operations**" on pages 27, 149 and 355, respectively, and elsewhere in this Draft Red Herring Prospectus have been calculated on the basis of amounts derived from the Restated Financial Statements.

### **Non-Generally Accepted Accounting Principles Financial Measures**

Certain non-generally accepted accounting principle ("**Non-GAAP**") measures, such as EBITDA ("**Non-GAAP Measures**") presented in this Draft Red Herring Prospectus are a supplemental measure of our performance and liquidity that are not required by, or presented in accordance with Ind AS. Further, these Non-GAAP Measures are not a measurement of our financial performance or liquidity under Ind AS and should not be considered in isolation or construed as an alternative to cash flows, profit/(loss) for the year/period or any other measure of financial performance or as an indicator of our operating performance, liquidity, profitability or cash flows generated by operating, investing or financing activities derived in accordance with Ind AS. In addition, these Non-GAAP Measures are not a standardised term, hence a direct comparison of similarly titled Non-GAAP Measures between companies may not be possible. Other companies may calculate the Non-GAAP Measures differently from us, limiting its usefulness as a comparative measure. Although the Non-GAAP Measures are not a measure of performance calculated in accordance with applicable accounting standards, our Company's management believes that they are useful to an investor in evaluating us because they are widely used measures to evaluate a company's operating performance.

### **Industry and Market Data**

The industry and market data set forth in this Draft Red Herring Prospectus have been obtained or derived from publicly available information as well as industry publications and sources. The data used in these sources may have been re-classified by us for the purposes of presentation. Data from these sources may also not be comparable. Industry sources and publications are also prepared based on information as of specific dates and may no longer be current or reflect current trends. Industry sources and publications may also base their information on estimates and assumptions that may prove to be incorrect.

In accordance with the SEBI ICDR Regulations, "**Basis of Offer Price**" on page 105 includes information relating to our listed peers. Accordingly, no investment decision should be made solely on the basis of such information.

The extent to which industry and market data set forth in this Draft Red Herring Prospectus is meaningful depends on the reader's familiarity with and understanding of the methodologies used in compiling such data. There are no standard data gathering methodologies in the industry in which we conduct our business, and methodologies and assumptions may vary widely among different industry sources. Accordingly, no investment decision should be made solely on the basis of such information. Such data involves risks, uncertainties and numerous assumptions and is subject to change based on various factors, including those disclosed in "**Risk Factors**" on page 27.

For the purpose of confirming our understanding of the industry in connection with the Offer, we have commissioned and paid for a report titled "*Global market assessment of 3PL and PMP products in Agriculture and Construction Equipment*" dated April, 2022 prepared by CRISIL Research, a division of CRISIL Limited, who was appointed on December 15, 2021. CRISIL has required us to include the following disclaimer in

connection with the CRISIL Report:

*“CRISIL Research, a division of CRISIL Limited (CRISIL) has taken due care and caution in preparing this report (Report) based on the Information obtained by CRISIL from sources which it considers reliable (Data). This Report is not a recommendation to invest / disinvest in any entity covered in the Report and no part of this Report should be construed as an expert advice or investment advice or any form of investment banking within the meaning of any law or regulation. Without limiting the generality of the foregoing, nothing in the Report is to be construed as CRISIL providing or intending to provide any services in jurisdictions where CRISIL does not have the necessary permission and/or registration to carry out its business activities in this regard. Uniparts India Limited will be responsible for ensuring compliances and consequences of non-compliances for use of the Report or part thereof outside India. CRISIL Research operates independently of, and does not have access to information obtained by CRISIL Ratings Limited / CRISIL Risk and Infrastructure Solutions Ltd (CRIS), which may, in their regular operations, obtain information of a confidential nature. The views expressed in this Report are that of CRISIL Research and not of CRISIL Ratings Limited / CRIS. No part of this Report may be published/reproduced in any form without CRISIL’s prior written approval.”*

The CRISIL Report is available at <https://www.unipartsgroup.com/ipo-industry-reports.asp?links=inv52>.

## FORWARD-LOOKING STATEMENTS

This Draft Red Herring Prospectus contains certain “forward-looking statements”. All statements regarding our expected financial condition and results of operations, business, plans and prospects are forward looking statements, which include statements with respect to our business strategy, our revenue and profitability, our goals and other matters discussed in this Draft Red Herring Prospectus regarding matters that are not historical facts. These forward-looking statements generally can be identified by words or phrases such as “aim”, “anticipate”, “believe”, “goal”, “expect”, “estimate”, “intend”, “likely to”, “objective”, “plan”, “project”, “propose”, “should”, “will”, “will continue”, “seek to”, “will pursue” or other words or phrases of similar import. Similarly, statements that describe our expected financial conditions, results of operations, strategies, objectives, prospects, plans or goals are also forward-looking statements. All forward-looking statements whether made by us or any third parties in this Draft Red Herring Prospectus are based on our current plans, estimates, presumptions and expectations and are subject to risks, uncertainties and assumptions about us that could cause actual results to differ materially from those contemplated by the relevant forward-looking statement.

Actual results may differ materially from those suggested by the forward-looking statements due to risks or uncertainties associated with the expectations with respect to, but not limited to, regulatory changes pertaining to the industry in which our Company has businesses and our ability to respond to them, our ability to successfully implement our strategy, our growth and expansion, technological changes, our exposure to market risks, general economic and political conditions in India and globally which have an impact on our business activities or investments, the monetary and fiscal policies of India, inflation, deflation, unanticipated turbulence in interest rates, foreign exchange rates, equity prices or other rates or prices, the performance of the financial markets in India and globally, changes in laws, incidence of any natural calamities and/or acts of violence, regulations and taxes and changes in competition in our industry. Important factors that could cause actual results to differ materially from our expectations include, but are not limited to, the following:

- Dependence on a limited number of customers for a significant portion of our revenues.
- Inability to accurately forecast demand for our products.
- Availability and cost of raw materials and labour.
- Exposure to foreign currency exchange rate fluctuations.
- Cyclical effects in the global and domestic economy, specifically in the agriculture and CFM sectors.
- Dependence on our Subsidiaries, Uniparts USA Limited and Uniparts Olsen Inc.
- Certain open bills in the Export Data Processing and Monitoring System of the Reserve Bank of India.
- Compounded delayed filing of certain records with the Reserve Bank of India in the past.

For a further discussion of factors that could cause our actual results to differ from our expectations, see “**Risk Factors**”, “**Our Business**” and “**Management’s Discussion and Analysis of Financial Condition and Results of Operations**” on pages 27, 149 and 355, respectively. By their nature, certain market risk disclosures are only estimates and could be materially different from what actually occurs in the future. As a result, actual gains or losses could materially differ from those that have been estimated.

Forward-looking statements reflect our views as of the date of this Draft Red Herring Prospectus and are not a guarantee of future performance. These statements are based on our management’s beliefs and assumptions, which in turn are based on the currently available information. Although we believe the assumptions upon which these forward-looking statements are based are reasonable, any of these assumptions could prove to be inaccurate, and the forward-looking statements based on these assumptions could be incorrect. None of our Company, Directors, the Selling Shareholders, and the BRLMs or their respective affiliates have any obligation to update or otherwise revise any statements reflecting circumstances arising after the date hereof or to reflect the occurrence of underlying events, even if the underlying assumptions do not come to fruition. There can be no assurance to Bidders that the expectations reflected in these forward-looking statements will prove to be correct. Given these uncertainties, Bidders are cautioned not to place undue reliance on such forward-looking statements and not to regard such statements to be a guarantee of our future performance.

In accordance with requirements of SEBI and as prescribed under applicable law, our Company and the BRLMs severally and not jointly, will ensure that Bidders in India are informed of material developments until the time of grant of listing and trading permission by the Stock Exchanges for the Equity Shares pursuant to the Offer.

## SUMMARY OF THE OFFER DOCUMENT

This section is a general summary of certain disclosures included in this Draft Red Herring Prospectus and is not exhaustive, nor does it purport to contain a summary of all the disclosures in this Draft Red Herring Prospectus or all details relevant to prospective investors. This summary should be read in conjunction with, and is qualified in its entirety by, the more detailed information appearing elsewhere in this Draft Red Herring Prospectus, including the sections titled “Risk Factors”, “Objects of the Offer”, “Our Business”, “Industry Overview”, “Capital Structure”, “The Offer” and “Outstanding Litigation and Material Developments” on pages 27, 103, 149, 111, 87, 76 and 389 respectively of this Draft Red Herring Prospectus.

### Summary of Business

We are a global manufacturer of engineered systems and solutions and are one of the leading suppliers of systems and components for the off-highway market in the agriculture and construction, forestry and mining and aftermarket sectors on account of our presence across over 25 countries (Source: CRISIL Report). We are a concept-to-supply player for precision products for off-highway vehicles with presence across the value chain. Our product portfolio includes core product verticals of 3-point linkage systems and precision machined parts as well as adjacent product verticals of power take off, fabrications and hydraulic cylinders or components thereof.

### Summary of Industry

The world market for 3-point linkages was estimated at USD 305 million – USD 320 million in 2020 and is expected to grow at nearly 6% - 8% between 2020 and 2025, buoyed by growth in tractor production volumes in North America, India and Europe, steady growth in China and Japan. The global market of PMP for articulated joints was an estimated USD 520 million in 2020. The demand for such products is expected to grow at a healthy 7% - 9% CAGR in the 5-year period between 2020 – 2025. (Source: CRISIL Report)

### Promoters

Our Promoters are Gurdeep Soni and Paramjit Singh Soni.

### Offer Size

Offer of up to 15,731,942 Equity Shares for cash at a price of ₹[●] per Equity Share aggregating up to ₹[●] million by the Selling Shareholders. The Offer would constitute 34.86% of the post-Offer paid-up Equity Share capital of our Company. For further details, see “The Offer” beginning on page 76.

### Objects of the Offer

The objects of the Offer are to (i) carry out the Offer for Sale of up to 15,731,942 Equity Shares by the Selling Shareholders aggregating up to ₹[●] million; and (ii) achieve the benefits of listing the Equity Shares on the Stock Exchanges. For further details, see “Objects of the Offer” on page 103.

### Aggregate Pre-Offer Shareholding of Promoters, members of the Promoter Group and Selling Shareholders

The aggregate pre-Offer shareholding of the Promoters, members of the Promoter Group and the Selling Shareholders as a percentage of pre-Offer paid-up Equity Share Capital of our Company, as on the date of this Draft Red Herring Prospectus is set out below:

Name of shareholder	Pre-Offer	
	No. of Equity Shares held	% of Equity Share capital
<b>Promoters</b>		
Gurdeep Soni	8,995,090	19.93%
Paramjit Singh Soni	200,000	0.44%
<b>Promoter Group</b>		
The Paramjit Soni 2018 CG-NG Nevada Trust	6,395,090	14.17%
The Karan Soni 2018 CG-NG Nevada Trust	5,200,000	11.52%
The Meher Soni 2018 CG-NG Nevada Trust	5,200,000	11.52%
Pamela Soni	3,000,000	6.65%

Name of shareholder	Pre-Offer	
	No. of Equity Shares held	% of Equity Share capital
Angad Soni	2,000,000	4.43%
Arjun Soni	2,000,000	4.43%
Tanya Kohli	1,000,000	2.22%
Jaswinder Singh Bhogal	102,948	0.23%
<b>Promoter Group Selling Shareholders</b>		
The Karan Soni 2018 CG-NG Nevada Trust	5,200,000	11.52%
The Meher Soni 2018 CG-NG Nevada Trust	5,200,000	11.52%
Pamela Soni	3,000,000	6.65%
<b>Investor Selling Shareholders</b>		
Ashoka Investment Holdings Limited	7,180,642	15.91%
Ambadevi Mauritius Holding Limited	2,154,192	4.77%
<b>Individual Selling Shareholders</b>		
Andrew Warren Code	177,378	0.39%
James Norman Hallene	177,378	0.39%
Kevin John Code	177,378	0.39%
Dennis Francis DeDecker	57,420	0.13%
Melvin Keith Gibbs	41,730	0.09%
Walter James Gruber	24,706	0.05%
Wendy Reichard Hammen	21,556	0.05%
Mark Louis Dawson	20,870	0.05%
Bradley Lorenz Miller	16,366	0.04%
Mary Louise Arp	10,440	0.02%
Diana Lynn Craig	8,340	0.02%
Marc Christopher Dorau	7,710	0.02%
Craig A Johnson	5,010	0.01%
Misty Marie Garcia	826	0.00%

### Summary of selected financial information derived from our Restated Financial Statements

(in ₹ million except per share data)

Particulars	As at and for the nine months ended December 31, 2021	As at and for the Fiscal ended March 31, 2021	As at and for the Fiscal ended March 31, 2020	As at and for the Fiscal ended March 31, 2019
Share capital	446.20	446.20	446.20	446.20
Net Worth	6,659.62	5,593.81	4,641.65	4,219.81
Revenue from operations	8,808.92	9,031.42	9,072.20	10,605.66
Profit after tax	1,223.36	923.86	626.42	695.97
Earnings per share (Basic)	27.73	20.95	14.20	15.78
Earnings per share (Diluted)	27.11	20.47	13.88	15.42
Net asset value per equity share	147.55	123.94	102.84	93.50
Total borrowings	1,409.58	1,277.77	2,564.97	3,456.28

Notes:

Basic earnings per share = Net profit after tax / Weighted average number of equity shares outstanding during the period/year.

Diluted earnings per share = Net profit after tax / Weighted average number of potential equity shares outstanding during the period/year.

Net asset value per share = Net worth as restated / Number of Equity Shares as at period/ year end.

Borrowings consist of current and non-current (including current maturities of long term borrowings) borrowings as per the Restated Financial Statements.

### Qualifications of the Auditors which have not been given effect to in the Restated Financial Statements

There are no qualifications of the Auditors in the examination report that have not been given effect to in the Restated Financial Statements.

### Summary of Outstanding Litigation and Material Developments

A summary of outstanding litigation proceedings involving our Company, our Subsidiaries, our Promoters and our Directors, as disclosed in this Draft Red Herring Prospectus, is provided below:

Particulars	Criminal Proceedings	Tax Proceedings	Actions by statutory or regulatory authorities	Disciplinary actions including penalty imposed by SEBI or stock exchanges against our Promoters	Material civil litigation	Aggregate amount involved* (₹ in million)
<b>Company</b>						
By our Company	2	-	-	-	1	67.91
Against our Company	-	28	1	-	-	102.23
<b>Directors</b>						
By our Directors	-	-	-	-	-	-
Against our Directors	-	5	-	-	-	1.82
<b>Promoters</b>						
By our Promoters	-	-	-	-	-	-
Against our Promoters	-	3	-	-	-	1.82
<b>Subsidiaries</b>						
By our Subsidiary	-	-	-	-	-	-
Against our Subsidiary	-	2	-	-	-	0.20

\*Amount to the extent quantifiable.

There are no group companies of our Company, as on the date of this Draft Red Herring Prospectus. For further details of the outstanding litigation proceedings, see “*Outstanding Litigation and Material Developments*” on page 389.

## Risk Factors

Specific attention of the investors is invited to the section “*Risk Factors*” on page 27. Investors are advised to read the risk factors carefully before taking an investment decision in the Offer.

## Summary of Contingent Liabilities

A summary of our contingent liabilities as on December 31, 2021 as indicated in our Restated Financial Statements is as follows:

Particulars	(in ₹ million) As of December 31, 2021
<b>(i) Contingent liabilities:</b>	
<b>(a) Claims against the Company not acknowledged as debt:</b>	
Sales Tax Matters	2.51
Service Tax Matters	-
Excise Matters	0.21
Custom Matters	-
GST Matters	0.36
Others	-
Labour Matters	Not ascertainable
<b>(b) Income Tax Demands</b>	<b>59.74</b>
<b>(c) Sales Tax Liability against pending forms</b>	<b>-</b>
<b>(d) Others</b>	<b>-</b>
<b>a) Guarantees given on behalf of the Company by the banks:</b>	
Sales Tax Matters	0.03
Pollution Control Board	0.05
Excise Matters	-
Custom Matters	-
Gas Connections	2.68
<b>b) Other money for which the Company is contingently liable:</b>	
SBLC (Stand By Letter of Credit) for Wholly Owned Subsidiaries	-
<b>(ii) Capital Commitments</b>	<b>-</b>
Estimated amount of contracts remaining to be executed on Capital Accounts and not provided for (Net of Advances)	36.88

For details, see “*Financial Statements – Annexure V - Note 30*” on page 289.

### Summary of Related Party Transactions

The following is the summary of transactions with related parties for the nine months ended December 31, 2021 and for Fiscals 2021, 2020 and 2019, as per the requirements under Ind AS read with the SEBI ICDR Regulations:

S. No	Particulars	Relationship	For the period ended December 31, 2021	For the year ended March 31, 2021	For the year ended March 31, 2020	For the year ended March 31, 2019
1	<b>Rent Paid</b>					
	Soni Holdings	Enterprises over which Key Managerial Personnel and their relatives exercise significant influence	1.49	1.99	1.84	1.87
	<b>Total</b>		<b>1.49</b>	<b>1.99</b>	<b>1.84</b>	<b>1.87</b>
2	<b>Sitting fees</b>					
	Alok Nagory	Independent Director	0.16	0.34	0.05	0.20
	Madhukar Rangnath Umarji	Independent Director	-	-	0.16	0.39
	Sharat Krishan Mathur	Independent Director	0.33	0.55	0.18	0.61
	Shradha Suri	Independent Director	0.15	0.15	0.05	0.15
	Parmeet Singh Kalra	Independent Director	0.06	0.08	0.02	0.08
	<b>Total</b>		<b>0.70</b>	<b>1.12</b>	<b>0.46</b>	<b>1.43</b>
3	<b>Dividend Paid</b>					
	Angad Soni	Relative of Key Managerial Personnel	6.60	-	0.06	0.05
	Gurdeep Soni	Key Managerial Personnel	29.68	-	17.95	14.96
	Pamela Soni	Relative of Key Managerial Personnel	9.90	-	2.38	1.98
	Arjun Soni	Relative of Key Managerial Personnel	6.60	-	0.01	0.01
	Paramjit Singh Soni	Key Managerial Personnel	0.66	-	1.20	6.60
	Meher Soni	Relative of Key Managerial Personnel	-	-	1.80	5.20
	Karan Soni	Relative of Key Managerial Personnel	-	-	1.44	5.20
	Rini Kalra	Head M&A / Funding	-	-	0.01	0.01
	Tanya Kohli	Relative of Key Managerial Personnel	3.30	-	-	-
	The Paramjit Soni 2018 CG-NG Nevada Trust	-	21.10	-	6.71	-
	The Karan Soni 2018 CG-NG Nevada Trust	-	17.16	-	4.80	-
	The Meher Soni 2018 CG-NG Nevada Trust	-	17.16	-	4.44	-
	Uniparts ESOP Trust	-	3.36	-	1.23	1.03
	<b>Total</b>		<b>115.52</b>	<b>-</b>	<b>42.03</b>	<b>35.04</b>
4	<b>Commission</b>					
	Madhukar Rangnath Umarji	Independent Director	-	-	0.30	0.60
	<b>Total</b>		<b>-</b>	<b>-</b>	<b>0.30</b>	<b>0.60</b>

S. No	Particulars	Relationship	For the period ended December 31, 2021	For the year ended March 31, 2021	For the year ended March 31, 2020	For the year ended March 31, 2019
5	<b>Salary and Allowances</b>					
	Angad Soni	Relative of Key Managerial Personnel	-	-	-	2.16
	<b>Total</b>		<b>-</b>	<b>-</b>	<b>-</b>	<b>2.16</b>
6	<b>Key Managerial Person Remuneration**</b>					
	Sanjiv Kashyap	Chief Financial Officer	-	-	1.27	10.15
	Sudhakar Simhachala Kolli	Group Chief Operating Officer	17.88	17.74	16.79	17.97
	Mukesh Kumar	Company Secretary	-	5.73	6.06	5.42
	Munish Sapra	Chief Financial Officer	10.22	11.83	10.29	2.43
	Rini Kalra	Head M&A / Funding	-	-	6.60	12.70
	Gurdeep Soni	Key Managerial Personnel	19.37	17.34	23.13	18.90
	Paramjit Singh Soni	Key Managerial Personnel	29.24	29.23	37.22	36.71
	Herbert Klaus Coenen	Director	18.68	21.25	20.19	16.99
	Ashish Srivastava	Company Secretary	1.91	-	-	-
	Divya Aggarwal	Company Secretary	-	0.11	1.25	1.24
	Deepika Sharma	Company Secretary	0.05	0.92	-	-
	<b>Total</b>		<b>97.35</b>	<b>104.15</b>	<b>122.80</b>	<b>122.51</b>
7	<b>ESOP Expenses to Key Managerial Person***</b>					
	Mukesh Kumar	Company Secretary	-	0.08	0.10	0.03
	Sudhakar Simhachala Kolli	Group Chief Operating Officer	0.63	1.61	1.91	0.67
	Rini Kalra	Head M&A / Funding	-	-	1.91	0.67
	<b>Total</b>		<b>0.63</b>	<b>1.69</b>	<b>3.92</b>	<b>1.37</b>

\*\* Excludes contribution to employee retirement/post retirement and other employee benefits which are based on actuarial valuation done on an overall Company basis.

\*\*\* Based on ESOP valuation on the date of grant, the fair value of grant is charged to statement of profit and loss on the basis of vesting period.

S.No.	Particulars	Relationship	For the period ended December 31, 2021	For the year ended March 31, 2021	For the year ended March 31, 2020	For the year ended March 31, 2019
1	<b>Purchase of Goods/Samples/Packing and Services</b>					
	Gripwel Fasteners Pvt. Ltd.	Subsidiary		21.30	23.96	17.24
	Uniparts India GmbH	Subsidiary		18.14	22.90	18.41
	<b>Total</b>			<b>39.44</b>	<b>46.86</b>	<b>35.65</b>
2	<b>Sale of Goods/Service</b>					
	Gripwel Fasteners Pvt. Ltd.	Subsidiary		773.39	741.72	597.39
	Uniparts India GmbH	Subsidiary		679.96	643.14	522.52
	Uniparts Olsen Inc.	Step-Down Subsidiary		854.77	667.59	810.74
	Uniparts USA Limited	Subsidiary		941.06	695.76	719.89
						899.73



S.No.	Particulars	Relationship	For the period ended December 31, 2021	For the year ended March 31, 2021	For the year ended March 31, 2020	For the year ended March, 31 2019
	<b>Total</b>		<b>3,249.18</b>	<b>2,748.21</b>	<b>2,650.54</b>	<b>3,272.26</b>
3	<b>Sale of Fixed Asset</b>					
	Gripwel Fasteners Pvt. Ltd.	Subsidiary	-	3.42	-	9.03
	<b>Total</b>		<b>-</b>	<b>3.42</b>	<b>-</b>	<b>9.03</b>
4	<b>Job Work income</b>					
	Gripwel Fasteners Pvt. Ltd.	Subsidiary	5.50	2.80	0.84	1.51
	<b>Total</b>		<b>5.50</b>	<b>2.80</b>	<b>0.84</b>	<b>1.51</b>
5	<b>Lease Rent on Machine Received</b>					
	Gripwel Fasteners Pvt. Ltd.	Subsidiary	0.03	0.04	0.04	5.96
	<b>Total</b>		<b>0.03</b>	<b>0.04</b>	<b>0.04</b>	<b>5.96</b>
6	<b>Air Freight Expenses</b>					
	Uniparts India GmbH	Subsidiary	0.57	-	-	-
	<b>Total</b>		<b>0.57</b>	<b>-</b>	<b>-</b>	<b>-</b>
7	<b>Current Account Receipts</b>					
	Gripwel Fasteners Pvt. Ltd.	Subsidiary	10.68	7.62	6.69	12.45
	<b>Total</b>		<b>10.68</b>	<b>7.62</b>	<b>6.69</b>	<b>12.45</b>
8	<b>Current Account Payments</b>					
	Gripwel Fasteners Pvt. Ltd.	Subsidiary	10.68	7.62	6.69	12.45
	<b>Total</b>		<b>10.68</b>	<b>7.62</b>	<b>6.69</b>	<b>12.45</b>
9	<b>Other Income</b>					
	Uniparts Olsen Inc.	Step-Down Subsidiary	-	0.21	0.62	0.11
	Uniparts USA Limited	Subsidiary	-	-	0.02	0.02
	Uniparts India GmbH	Subsidiary	20.09	30.16	0.74	1.65
	Gripwel Fasteners Pvt. Ltd.	Subsidiary	0.19	0.19	0.26	-
	<b>Total</b>		<b>20.28</b>	<b>30.56</b>	<b>1.64</b>	<b>1.78</b>
10	<b>Guarantees and Collaterals Given to</b>					
	Gripwel Fasteners Pvt. Ltd.	Subsidiary	225.00	225.00	225.00	225.00
	<b>Total</b>		<b>225.00</b>	<b>225.00</b>	<b>225.00</b>	<b>225.00</b>
11	<b>Guarantees and Collaterals Given by</b>					
	Gripwel Fasteners Pvt. Ltd.	Subsidiary	100.00	200.00	200.00	200.00
	<b>Total</b>		<b>100.00</b>	<b>200.00</b>	<b>200.00</b>	<b>200.00</b>
12	<b>Dividend Income</b>					

S.No.	Particulars	Relationship	For the period ended December 31, 2021	For the year ended March 31, 2021	For the year ended March 31, 2020	For the year ended March 31 2019
	Gripwel Fasteners Pvt. Ltd	Subsidiary	50.11	100.80	51.84	37.44
	<b>Total</b>		<b>50.11</b>	<b>100.80</b>	<b>51.84</b>	<b>37.44</b>

For details of the related party transactions in accordance with Ind AS 24, see “*Financial Statements – Annexure V - Note 38 - Related Party Disclosure*” on page 306.

### Financing Arrangements

There have been no financing arrangements whereby our Promoters, members of the Promoter Group, our Directors and their relatives have financed the purchase by any other person of securities of our Company during a period of six months immediately preceding the date of this Draft Red Herring Prospectus.

### Weighted average price at which specified securities were acquired by our Promoters and the Selling Shareholders in the one year preceding the date of this Draft Red Herring Prospectus

The weighted average price at which our Promoters and the Selling Shareholders acquired the equity shares or preference shares in the one year immediately preceding the date of this Draft Red Herring Prospectus are as follows:

(a) Promoters

Promoters	Number of Equity Shares acquired in the one year preceding the date of this Draft Red Herring Prospectus	Weighted average price per Equity Share (in ₹)*
Gurdeep Soni	Nil	Nil
Paramjit Singh Soni	Nil	Nil

\*As certified by Rakesh Banwari & Co., Chartered Accountants, our Statutory Auditors, by way of their certificate dated April 25, 2022.

(b) Selling Shareholders

Selling Shareholders	Number of Equity Shares acquired in the one year preceding the date of this Draft Red Herring Prospectus	Weighted average price per Equity Share (in ₹)*
<b>Promoter Group Selling Shareholders</b>		
The Karan Soni 2018 CG-NG Nevada Trust	Nil	Nil
The Meher Soni 2018 CG-NG Nevada Trust	Nil	Nil
Pamela Soni	Nil	Nil
<b>Investor Selling Shareholders</b>		
Ashoka Investment Holdings Limited	Nil	Nil
Ambadevi Mauritius Holding Limited	Nil	Nil
<b>Individual Selling Shareholders</b>		
Andrew Warren Code	Nil	Nil
James Norman Hallene	Nil	Nil
Kevin John Code	Nil	Nil
Dennis Francis DeDecker	Nil	Nil
Melvin Keith Gibbs	Nil	Nil
Walter James Gruber	Nil	Nil
Wendy Reichard Hammen	Nil	Nil
Mark Louis Dawson	Nil	Nil
Bradley Lorenz Miller	Nil	Nil
Mary Louise Arp	Nil	Nil
Diana Lynn Craig	Nil	Nil
Marc Christopher Dorau	Nil	Nil
Craig A Johnson	Nil	Nil
Misty Marie Garcia	Nil	Nil

\*As certified by Rakesh Banwari & Co., Chartered Accountants, our Statutory Auditors, by way of their certificate dated April 25, 2022.

For further details, see “*Capital Structure*” on page 87.

### Details of price at which specified securities were acquired in the last three years immediately preceding the date of this Draft Red Herring Prospectus

Except as stated below, none of the Promoters, Promoter Group and the Selling Shareholders have acquired any specified securities in the last three years immediately preceding the date of this Draft Red Herring Prospectus:

S.No.	Name of the acquirer/ shareholder	Date of acquisition of Equity Shares	Number of Equity Shares	Face value of Equity Share (in ₹)	Acquisition price per Equity Share (in ₹)*
<b>Promoter Group</b>					
1.	The Paramjit Soni 2018 CG-NG Nevada Trust	December 9, 2020	800,000	10	Nil <sup>(1)</sup>
2.	The Karan Soni 2018 CG-NG Nevada Trust	December 9, 2020	1,200,000	10	Nil <sup>(1)</sup>
3.	The Meher Soni 2018 CG-NG Nevada Trust	December 11, 2020	1,500,000	10	Nil <sup>(1)</sup>
4.	Pamela Soni	January 8, 2021	1,020,480	10	Nil <sup>(1)</sup>
5.	Angad Soni	January 8, 2021	1,950,000	10	Nil <sup>(1)</sup>
6.	Arjun Soni	January 8, 2021	1,990,000	10	Nil <sup>(1)</sup>
7.	Tanya Kohli	January 8, 2021	1,000,000	10	Nil <sup>(1)</sup>
8.	Jaswinder Singh Bhogal	January 24, 2021	102,948	10	52.50
<b>Selling Shareholders</b>					
<i>Promoter Group Selling Shareholders</i>					
9.	The Karan Soni 2018 CG-NG Nevada Trust	December 9, 2020	1,200,000	10	Nil <sup>(1)</sup>
10.	The Meher Soni 2018 CG-NG Nevada Trust	December 11, 2020	1,500,000	10	Nil <sup>(1)</sup>
11.	Pamela Soni	January 8, 2021	1,020,480	10	Nil <sup>(1)</sup>

\* As certified by Rakesh Banwari & Co., Chartered Accountants, our Statutory Auditors, by way of their certificate dated April 25, 2022.

<sup>(1)</sup> Represents transfer by way of gift and no consideration was paid.

There are no other Shareholders who have a right to nominate Directors on our Board or have any other special rights.

### Average cost of acquisition for Promoter and the Selling Shareholders

The average cost of acquisition per Equity Share acquired by our Promoters and the Selling Shareholders, as on the date of this Draft Red Herring Prospectus is:

S. No.	Name of entity/ individual	Number of Equity Shares on a fully diluted basis	Average Cost of Acquisition per Equity Share (in ₹)*
<b>Promoters</b>			
1.	Gurdeep Soni	8,995,090	9.97
2.	Paramjit Singh Soni	200,000	9.85
<b>Selling Shareholders</b>			
<i>Promoter Group Selling Shareholders</i>			
3.	The Karan Soni 2018 CG- NG Nevada Trust	5,200,000	Nil <sup>(1)</sup>
4.	The Meher Soni 2018 CG- NG Nevada Trust	5,200,000	Nil <sup>(1)</sup>
5.	Pamela Soni	3,000,000	6.27
<i>Investor Selling Shareholders</i>			
6.	Ashoka Investment Holdings Limited <sup>(1)</sup>	7,180,642	88.45
7.	Ambadevi Mauritius Holding Limited <sup>(1)</sup>	2,154,192	88.45
<i>Individual Selling Shareholders</i>			
8.	Andrew Warren Code	177,378	105.74
9.	James Norman Hallene	177,378	105.74
10.	Kevin John Code	177,378	105.74
11.	Dennis Francis DeDecker	57,420	105.74

S. No.	Name of entity/ individual	Number of Equity Shares on a fully diluted basis	Average Cost of Acquisition per Equity Share (in ₹)*
12.	Melvin Keith Gibbs	41,730	105.74
13.	Walter James Gruber	24,706	105.74
14.	Wendy Reichard Hammen	21,556	105.74
15.	Mark Louis Dawson	20,870	147.36
16.	Bradley Lorenz Miller	16,366	105.74
17.	Mary Louise Arp	10,440	105.74
18.	Diana Lynn Craig	8,340	105.74
19.	Marc Christopher Dorau	7,710	105.74
20.	Craig A Johnson	5,010	105.74
21.	Misty Marie Garcia	826	105.64

\* As certified by Rakesh Banwari & Co., Chartered Accountants, our Statutory Auditors, by way of their certificate dated April 25, 2022.

<sup>(1)</sup> Represents transfer by way of gift and no consideration was paid.

For further details, see “*Capital Structure*” on page 87.

#### **Details of Pre-IPO Placement**

Not applicable.

#### **Issue of Equity Shares through bonus or for consideration other than cash in the last one year**

Our Company has not issued any Equity Shares through bonus or for consideration other than cash in the one year preceding the date of this Draft Red Herring Prospectus.

#### **Split / Consolidation of Equity Shares in the last one year**

Our Company has not undertaken a split or consolidation of the Equity Shares in the one year preceding the date of this Draft Red Herring Prospectus.

#### **Exemption from complying with any provisions of securities laws, if any, granted by SEBI**

Our Company, pursuant to its letter dated April 25, 2022 has sought an exemption from the inclusion of Navjit Bindra, sister of the spouse of our Promoter Paramjit Singh Soni, from inclusion in the “Promoter Group” on account of not receiving information from Navjit Bindra and entities she may be interested in, for inclusion in this Draft Red Herring Prospectus.

## SECTION II - RISK FACTORS

Any investment in equity shares involves a high degree of risk. You should carefully consider all the information in this Draft Red Herring Prospectus, including the risks, uncertainties and challenges described below, before making an investment in our Equity Shares. The risks described below are not the only ones relevant to us or our Equity Shares or the industry in which we operate. Additional risks and uncertainties not presently known to us or that we deem immaterial may also impair our business, results of operations, financial condition or cash flows. To the extent the COVID-19 pandemic adversely affects our business and financial results, it may also have the effect of heightening many of the other risks described in this section. You should read this section in conjunction with “**Our Business**”, “**Industry Overview**” and “**Management’s Discussion and Analysis of Financial Condition and Results of Operations**” on pages 149, 111 and 355, respectively, as well as the other financial and statistical information contained in this Draft Red Herring Prospectus. If any or a combination of the following risks, or other risks and uncertainties that are not currently known or are now deemed immaterial, actually materialize, our business, financial condition, results of operations and prospects may suffer, the trading price of our Equity Shares may decline, and all or part of your investment in our Equity Shares may be lost. Unless otherwise stated, we are not in a position to specify or quantify the financial or other risks mentioned here.

Prospective investors should consult their tax, financial and legal advisors about the particular consequences of investing in the Offer. Unless specified or quantified in the relevant risk factors below, we are unable to quantify the financial or other impact of any of the risks described in this section. Prospective investors should pay particular attention to the fact that our Company is incorporated under the laws of India and is subject to a legal and regulatory environment, which may differ in certain respects from that of other countries.

This Draft Red Herring Prospectus also contains certain forward-looking statements that involve risks, assumptions, estimates and uncertainties. Our actual results could differ from those anticipated in these forward-looking statements as a result of certain factors, including the considerations described below and elsewhere in this Draft Red Herring Prospectus. For further information, see “**Forward-Looking Statements**” on page 17. Unless otherwise indicated, the financial information included herein is based on our Restated Financial Statements included in this Draft Red Herring Prospectus. For further information, see “**Financial Statements**” on page 212. Unless otherwise indicated or the context otherwise requires, in this section, references to “the Company” or “our Company” are to Uniparts India Limited on a standalone basis, and references to “the Group”, “we”, “us”, “our”, are to Uniparts India Limited on a consolidated basis.

Unless otherwise indicated, industry and market data used in this section has been derived from industry publications, in particular, the report titled “Global Market Assessment of 3PL and PMP Products in Agriculture and Construction Equipment” dated April, 2022 (the “**CRISIL Report**”) prepared and issued by CRISIL Limited, appointed on December 15, 2021 and exclusively commissioned and paid for by us in connection with the Offer. A copy of the CRISIL Report is available on the website of our Company at [www.unipartsgroup.com/ipo-industry-reports.asp?links=inv52](http://www.unipartsgroup.com/ipo-industry-reports.asp?links=inv52). There are no parts, data or information (which may be relevant for the proposed issue), that has been left out or changed in any manner. Unless otherwise indicated, financial, operational, industry and other related information derived from the CRISIL Report and included herein with respect to any particular year refers to such information for the relevant calendar year. For more information, see “**Risk Factors – Industry information included in this Draft Red Herring Prospectus has been derived from an industry report commissioned by us, and paid for by us for such purpose.**” on page 34. Also see, “**Certain Conventions, Use of Financial Information and Market Data and Currency of Presentation – Industry and Market Data**” on page 15.

### Internal Risk Factors

#### Risks Relating to Our Business

1. **We depend on a limited number of customers for a significant portion of our revenues. The loss of a major customer or significant reduction in production and sales of, or demand for our products from, any of our major customers may adversely affect our business, financial condition, results of operations and prospects.**

A majority of our revenue from operations is from sales to Original Equipment Manufacturers (“**OEMs**”). Sales to OEMs was ₹ 8,718.75 million, ₹ 7,359.34 million, ₹ 6,982.35 million and ₹ 6,810.05 million and constituted 82.21%, 81.12%, 77.31% and 77.31%, respectively, of our revenue from operations in Fiscal 2019, 2020 and 2021 and in the nine months December 31, 2021, within which we depend on a limited number of customers for a

significant portion of our revenues. Revenue from our top 10 customers across product segments and geographies was ₹ 8,022.13 million, ₹ 6,769.73 million, ₹ 6,600.07 million and ₹ 6,230.21 million and constituted 75.64%, 74.62%, 73.08% and 70.73% of our revenue from operations for Fiscal 2019, 2020 and 2021 and in the nine months December 31, 2021, respectively. Set forth below are details of our product specific aggregate revenue from our top 10 customers in each product segment in the last three Fiscals and the nine months ended December 31, 2021.

	Fiscal 2019	Fiscal 2020	Fiscal 2021	Nine Months ended December 31, 2021
	(₹ million, except percentages)			
Revenue from top ten customers (3PL)	4,053.71	3,476.88	4,062.36	3,766.55
Revenue from top ten 3PL customers as a percentage of 3PL total sales	80.56%	81.24%	80.18%	76.79%
Revenue from top ten customers (PMP)	4,519.78	3,912.94	3,087.19	2,867.67
Revenue from top ten PMP customers as a percentage of total PMP sales	91.00%	90.51%	90.87%	89.57%
Revenue from top 10 customers (PTO)	94.67	64.48	82.14	90.32
Revenue from top 10 PTO customers as a percentage of total PTO sales	100.00%	100.00%	100.00%	100.00%
Revenue from top 10 customers (Hydraulic Cylinders)	12.11	6.66	7.87	4.59
Revenue from top 10 Hydraulic Cylinder customers as a percentage of total Hydraulic Cylinder sales	100.00%	100.00%	100.00%	100.00%
Revenue from top 10 customers (Fabrication)	69.34	77.18	84.08	87.35
Revenue from top 10 Fabrication customers as a percentage of total Fabrication sales	100.00%	100.00%	100.00%	100.00%

For further information on our key customers, see “*Our Business – Customers*” on page 170.

Demand for our products is directly related to the production and sales of off-highway vehicles (“OHVs”) by our major customers. OHV production and sales may be affected by general economic or industry conditions, including seasonal trends in the agricultural sector and cyclical effects in the construction, forestry and mining (“CFM”) sector, recessionary trends in the global and domestic economies, volatility in new housing construction as well as evolving regulatory requirements, government initiatives, trade agreements and other factors. For risks relating to cyclical effects which affect our business see “– *Our business is impacted by cyclical effects in the global and domestic economy, specifically in the agriculture and CFM sectors, which may have an adverse effect on our business, financial condition, results of operations and prospects*” on page 32.

It is difficult to forecast events which affect the profitability and liquidity of our customers or the success or sustainability of any strategies undertaken by any of our major customers in response to the current economic or industry environment. Unfavourable industry conditions can also result in an increase in commercial disputes and other risks of supply disruption. A sustained decline in the demand for products produced by our OEM customers could prompt them to cut their production volumes, directly affecting the demand from OEMs for our products. We disengaged with one of our customers in mutually agreed and phased manner during Fiscal 2020 and Fiscal 2021.

As our business is currently concentrated among relatively few significant customers, we may experience reduction in cash flows and liquidity if we lose one or more of our major customers or if the amount of business from one or more of them is significantly reduced for any reason, including as a result of a dispute with or disqualification by a major customer.

**2. *If we are unable to accurately forecast demand for our products, our business, cash flows, financial condition, results of operations and prospects may be adversely affected.***

The volume and timing of sales to our customers may vary due to variation in demand for our customers’ products, our customers’ attempts to manage their inventory, design changes, changes in their product mix, manufacturing strategy and growth strategy, and macroeconomic factors affecting the economy in general and our customers in particular. Our inability to accurately forecast the level of customer demand for our products, process innovation and value engineering costs as well as inability to accurately schedule our raw material purchases and production

and manage our inventory may adversely affect our business and cash flows from operations. In particular, our inability to accurately forecast demand for products in our emerging product verticals, comprising complementary product verticals of hydraulic cylinders and power take off (“**PTO**”) applications and fabrications, may hinder our planned growth in these verticals. For example, during the months from March 2020 to June 2020 on account of COVID-19 lockdowns, certain manufacturing plants of OEM customers were shutdown which made forecasting demand accurately difficult. In addition, in the months of October 2021 and November 2021, one of our key customers experienced strikes at their factories situated in the United States, which impacted our ability to accurately forecast demand for this customer. While these instances did not have any material impact on our operations, there can be no assurance that similar instances will not adversely impact our operations in future.

While we have arrangements with certain of our key OEM customers pursuant to which customers provide us with forecasts of business volumes which enable us to predict our income for a portion of our business, the actual orders are only placed by way of on-going purchase orders. While we continue to maintain long-term relationships with our OEM customers, we have transitioned from entering into long-term purchase agreements with such customers to undertaking work on a purchase order basis. OEMs develop new models and refine existing models on an on-going basis and may also phase out some of their existing models. Any or all of these developments by the OEMs may result in changes in product specifications and timing of procurement of the products and components that they source from us. The time taken by these OEMs for new product development and enhancements/refinements is difficult to estimate or predict as these are normally elongated which include conceptualization phase to development phase and then field testing and trials. This is particularly true for OHVs where the long lead times for new OHV models, and related programs for the development and manufacture of our products may make it difficult to predict the timing of income that we will earn in respect of new programs. In addition, actual production volumes may vary from these estimates due to variations in consumer demand for the related products leading to underutilized capacity or incurring additional expenditure to deploy additional resources to meet delivery timelines.

Additionally, in the event of significant cuts in production schedules announced by customers with little advance notice, we may be unable to respond with corresponding production and inventory reductions and we may be required to reorganize our production schedules. Such instances may occur from time to time in the ordinary course of business, including due to changes in product specifications, extremity of weather condition, seasonal/cyclical nature of the sectors in which we operate and global economic downturns affecting the OHV sector, amongst other things. In particular, we faced such cuts in production, which had materially affected our business during the global financial crisis in 2008 and again during the agriculture and CFM sector slow-down particularly between 2014 and 2016 and there can be no assurance that such instances will not occur in the future. In addition, customers may seek to dispute or vary the price of our products for factors which are not in our control, such as inflation. While this is endemic to our industry, we have limited ability to counter such effects considering that the underlying factor is beyond our control. While we have not historically tracked details of revenue losses occurring on account of production cuts, a significant reduction in demand for our products from a major customer may have an adverse effect on our business, financial condition, results of operations and prospects.

We classify our global business model based on our sales in regions outside India (“**International Sales**”); sales from our manufacturing facilities in their respective domestic markets (“**Local Deliveries**”); export sales from Indian locations directly to overseas customers (“**Direct Exports**”); and sales from our warehousing facilities in their respective domestic markets (“**Warehouse Sales**”).

We expect that the proportion of our Warehouse Sales may increase as compared to our Direct Exports and Local Deliveries, going forward. As a result, this may lead to a mismatch between increased inventory maintained at our warehouses and actual delivery schedules. As of March 31, 2019, 2020 and 2021 and as of December 31, 2021, our inventory turnover ratio was 1.11, 0.91, 1.02 and 0.69, respectively. Set forth below is a detailed break-up of our revenue from operations from such Warehouse Sales, Direct Exports and Local Deliveries in Fiscal 2019, 2020 and 2021, and in the nine months ended December 31, 2021.

Particulars	Fiscal 2019		Fiscal 2020		Fiscal 2021		Nine Months ended December 31, 2021	
	(₹ million)	Percentage of Revenue from Operations (%)	(₹ million)	Percentage of Revenue from Operations (%)	(₹ million)	Percentage of Revenue from Operations (%)	(₹ million)	Percentage of Revenue from Operations (%)
International Sales	8,830.04	83.26	7,580.04	83.55	7,255.36	80.33	7,175.29	81.45
Local Deliveries	3,624.05	34.19	2,945.63	32.47	2,547.04	28.20	2,210.78	25.10
Direct Exports	2,480.25	23.36	2,065.04	22.76	2,428.49	26.89	2,743.51	31.14
Warehouse Sales	4,065.13	38.33	3,715.42	40.95	3,713.11	41.11	3,491.67	39.64

Moreover, as many of our operating expenses are relatively fixed, an unanticipated change in customer demand or preferences may adversely affect our liquidity and financial condition. We typically commit to order raw materials and bought-out components from our own suppliers based on customer forecasts and orders. Cancellation by customers or delay or reduction in their orders or instances where anticipated orders fail to materialize can result in mismatch between our inventories of raw materials and bought-out components and of manufactured products, thereby increasing our costs relating to maintaining our inventory and reduction of our margins, which may adversely affect our profitability and liquidity. From time to time, in the ordinary course of business, our customers may announce reorganization in product scheduling, including due to such unanticipated changes in customer preferences, cancellation by customers or delay or instances where anticipated orders fail to materialize, owing to which our products may become obsolete or unutilized, which adversely affect our business, financial condition, results of operations and prospects. While we have not historically tracked such instances or any resultant loss and believe that such instances in the past have not been significant, there can be no assurance that such instances in the future will not have a material adverse effect on our liquidity, profitability and financial condition. Further, since finished inventory is maintained at our manufacturing facilities and warehouses in anticipation of demand, such products may be susceptible to unanticipated changes in customer preferences which may render our finished products obsolete or unutilized in meeting demand to the extent anticipated, thereby adversely affecting our liquidity and financial position.

In addition, the recent geopolitical situation and war between Ukraine and Russia is likely to cause supply chain disruptions across Europe and our operations and the operations of our customers in Europe could be potentially impacted. The level, duration and extent of direct or indirect impact cannot be fully ascertained.

### ***3. Availability and cost of raw materials and labour may adversely affect our business, financial condition, results of operations and prospects.***

Our business, financial condition, results of operations and prospects are significantly impacted by the availability and cost of raw materials, particularly steel, power and fuel as well as employee benefit expenses. Our cost of raw material and components consumed, including purchase of stock-in-trade and change in inventory, was ₹ 3,723.24 million, ₹ 3,287.86 million, ₹ 3,528.90 million and ₹ 2,741.07 million, and represented 38.35%, 38.03%, 42.56% and 38.38% of our total expenses in Fiscal 2019, 2020 and 2021, and in the nine months ended December 31, 2021, respectively. Steel purchases were ₹ 2,743.45 million, ₹ 1,971.72 million, ₹ 2,004.96 million and ₹ 2,314.11 million, respectively, and accounted for 62.02%, 62.69%, 59.18% and 59.96% of our total raw material purchases in Fiscal 2019, 2020 and 2021 and in the nine months ended December 31, 2021, respectively. We purchase steel required for our manufacturing facilities in India primarily through spot contracts in the domestic and international markets. Steel used for products manufactured in our facility at Eldridge, Iowa, United States is primarily sourced in the United States from distributors.

While we are not significantly dependent on any single raw material supplier, raw material supply and pricing can be volatile due to a number of factors beyond our control, including global demand and supply, general economic and political conditions, transportation and labour costs, labour unrest, natural disasters, competition, import duties, tariffs and currency exchange rates, and there are uncertainties inherent in estimating such variables, regardless of the methodologies and assumptions that we may use. This volatility in commodity prices (in particular, the cost of steel) can significantly affect our raw material costs. Further, volatility in fuel prices can also affect commodity prices worldwide which may increase our raw material costs. Moreover, given that our Company obtains certain of our raw materials, in particular seamless tubes from China, any disruption in supply chain in China could lead to a delay in business operations at our facilities, and could have an impact on our results of operations and profitability. Further, concerns about India's strained relationship with China could also have an adverse impact on trade relations. Additionally, rising freight costs could also impact the supply and prices of



raw materials which we may not be able to pass on to our customers and in turn our affect our results of operations and profitability. For further information, see “- *Our operational flexibility may be limited in certain respects on account of our obligations under some of our customer agreements, terms of purchase and established practices.*” on page 48.

In Fiscal 2019, 2020 and 2021 and in the nine months ended December 31, 2021, our employee benefits expense were ₹ 2,217.42 million, ₹ 2,117.62 million, ₹ 1,854.48 million and ₹ 1,605.86 million, respectively, and accounted for 22.84%, 24.50%, 22.37% and 22.48%, respectively, of our revenue from operations in such periods. Our employee benefit expenses are affected by statutorily prescribed minimum wage as well as wage payments following retrenchment. In recent times, labour related costs have been rising in India. For instance, in Fiscal 2018, minimum wages across states in India were increased by a higher than usual margin which in turn affected our costs. In order to retain flexibility and control costs, we appoint independent contractors who, in turn, engage on-site contract labour to perform certain operations. Although we do not engage these labourers directly, in the event of default by any independent contractor, we may be held responsible for any wage payments that must be made to such labourers. If we are required to pay the wages of the contracted employees, our results of operations may be adversely affected.

While we typically agree to renegotiate/reset prices of our products to include adjustments beyond a specific range (which may vary between customers), as this is done on a periodic basis and prices are otherwise generally fixed, we may not be able to pass on increase in raw material or labour costs to our customers within this range or at all.

To the extent that we are unable to successfully manage related risks and secure adequate supplies of raw materials and labour on commercially reasonable terms or to pass on price increases to our customers, our profitability may be adversely impacted.

**4. We are exposed to foreign currency exchange rate fluctuations, which may harm our results of operations and cause our results to fluctuate.**

We are exposed to foreign exchange rate fluctuations in respect of (i) our foreign currency denominated borrowings (mainly in US Dollar), (ii) currency mismatches between our revenues and expenses, and (iii) currency translation losses for the purpose of preparing our consolidated financial statements (which are presented in Indian Rupees), on account of our global operations.

Our revenues, operating expenses and finance costs are influenced by the currencies of those countries where we manufacture and/or sell our products (for example, the United States, Europe and Japan). The exchange rate between the Indian Rupee and these currencies, primarily the US Dollar, has fluctuated in the past and our results of operations have been impacted by such fluctuations in the past and may be impacted by such fluctuations in the future. For example, during times of strengthening of the Indian Rupee, we expect that our overseas sales and revenues will generally be negatively impacted as foreign currency received will be translated into fewer Indian Rupees. However, the converse positive effect of depreciation in the Indian Rupee may not be sustained or may not show an appreciable impact in our results of operations in any given financial period due to other variables impacting our business and results of operations during the same period. Moreover, as a majority of our long-term (non-current) and working capital borrowings are US Dollar denominated, we expect that our cost of borrowing as well as our cost of raw materials and components incurred by our foreign Subsidiaries may rise during a sustained depreciation of the Indian Rupee against the US Dollar. Set forth below is a break-up of our foreign currency inflows and outflows in Fiscal 2019, 2020 and 2021, and in the nine months ended December 31, 2021.

	Fiscal 2019		Fiscal 2020		Fiscal 2021		Nine months ended December 31, 2021	
	Amount (₹ million)	Percentage of Revenue from Operations (%)	Amount (₹ million)	Percentage of Revenue from Operations (%)	Amount (₹ million)	Percentage of Revenue from Operations (%)	Amount (₹ million)	Percentage of Revenue from Operations (%)
<b>Revenue from Operations</b>	6,530.09	100.00	5,378.62	100.00	5,911.75	100.00	6,569.44	100.00
- Within India	2,461.37	37.69	2,009.98	37.37	2,443.90	41.34	2,362.28	35.96
- Outside India	4,068.72	62.31	3,368.64	62.63	3,467.85	58.66	4,207.16	64.04
<b>Operating Expenses incurred in Foreign Exchange</b>	233.34	3.57	165.60	3.08	144.91	2.45	127.01	1.93
<b>Total Operating Expenses</b>	6,181.64	94.66	5,436.99	101.09	5,183.46	87.68	5,652.35	86.04
<b>Finance Costs incurred in Foreign Exchange</b>	60.20	0.92	45.75	0.85	25.51	0.43	15.77	0.24

	Fiscal 2019		Fiscal 2020		Fiscal 2021		Nine months ended December 31, 2021	
	Amount (₹ million)	Percentage of Revenue from Operations (%)	Amount (₹ million)	Percentage of Revenue from Operations (%)	Amount (₹ million)	Percentage of Revenue from Operations (%)	Amount (₹ million)	Percentage of Revenue from Operations (%)
- Interest Paid on PCFCs Loans	49.94	0.76	40.51	0.75	23.29	0.39	15.75	0.24
<b>Total Finance Cost</b>	<b>115.31</b>	<b>1.77</b>	<b>113.07</b>	<b>2.10</b>	<b>50.26</b>	<b>0.85</b>	<b>25.63</b>	<b>0.39</b>
<b>Current Borrowing incurred in Foreign Exchange</b>	<b>1,411.94</b>	<b>21.62</b>	<b>1,423.85</b>	<b>26.47</b>	<b>924.39</b>	<b>15.64</b>	<b>1,065.17</b>	<b>16.21</b>
<b>Non-current Borrowing (Term Loans) incurred in Foreign Exchange</b>	<b>79.62</b>	<b>1.22</b>	<b>12.92</b>	<b>0.24</b>	<b>-</b>	<b>-</b>	<b>-</b>	<b>-</b>
<b>Total Borrowing</b>	<b>2,223.19</b>	<b>34.05</b>	<b>1,728.23</b>	<b>32.13</b>	<b>1,059.63</b>	<b>17.92</b>	<b>1,111.00</b>	<b>16.91</b>
<b>Receivables in Foreign Currency</b>	<b>704.84</b>	<b>10.79</b>	<b>633.13</b>	<b>11.77</b>	<b>686.06</b>	<b>11.61</b>	<b>1,024.09</b>	<b>15.59</b>
<b>Total Receivables</b>	<b>1,014.76</b>	<b>15.54</b>	<b>847.09</b>	<b>15.75</b>	<b>1,163.49</b>	<b>19.68</b>	<b>1,463.42</b>	<b>22.28</b>

For further information, see “*Restated Financial Statements*” on page 212.

Our arrangements with several customers do not include exchange rate fluctuation provisions. Accordingly, our ability to pass on the impact of future foreign currency fluctuations and reset prices with customers is therefore limited. In cases where price reset on account of foreign currency fluctuation is permitted, adjustments in our price list are generally effected with prospective effect and may not be adequate to entirely off-set the impact of foreign currency fluctuations, which in turn could have a material adverse impact on our results of operations and financial condition. Under our Forex Risk Management and Hedging Policy, our Forex Risk Hedging Committee (comprising Gurdeep Soni, Promoter and Chairman and Managing Director and Munish Sapra, Group Chief Financial Officer and our treasury team (Munish Sapra, Group Chief Financial Officer assisted by an associate vice president from our corporate controls division) monitor our foreign exchange exposure on a monthly basis in terms of booked exposures (comprising an outstanding foreign currency transaction not as yet settled), economic exposure (in terms of foreign exchange rate movements which are more favourable for our competitors located in other jurisdictions) and local foreign currency exposure (comprising liquidity or cash holding in a currency other than Indian Rupees). While we seek to hedge our foreign currency exchange risk by entering into forward exchange contracts or matching our revenue and expenses currency as much as possible, any action that we may take and any amounts that we spend or invest in order to hedge the risks to our business due to fluctuations in currencies may not adequately hedge against any losses and we cannot assure you of the sufficiency of these procedures or whether the procedures we have in place will be successful in managing our foreign currency exposure. See “*Restated Financial Statements – Annexure V – Note 40*” on page 324.

**5. *Our business is impacted by cyclical effects in the global and domestic economy, specifically in the agriculture and CFM sectors, which may have an adverse effect on our business, financial condition, results of operations and prospects. Further, our business is also impacted by tractor production volumes globally.***

Our sales volumes, profitability and liquidity are closely tied to the level of agricultural and CFM activity worldwide, as our customers and end-users operate in the agriculture and CFM sectors and are, therefore, affected by factors that affect the agriculture and CFM sectors, including the levels of investment and production in these specific sectors of the global and domestic economies. The overall contribution of the agriculture and CFM sectors to overall economic growth and stability further underlines the impact caused by the level of activity in the agriculture and CFM sectors.

In particular, the agricultural sector is inherently seasonal and is further impacted by factors including agricultural commodity prices, costs of fertilizers and adverse weather conditions. If we are unable to adequately anticipate and respond to changing conditions affecting the agriculture and CFM sectors and the related cyclical effects on our customers, vendors and on our own operations, our business, financial condition, results of operations and prospects may be adversely affected.

Moreover, the seasonal nature of the agricultural sector as well as other cyclical effects in the economy may, at times, hinder comparison of our financial statements for any given fiscal quarter from our financial statements for any other given fiscal quarter.

Further, the world tractor demand was 1.8 million units in 2020, with approximately 70% contributed by the less than 60 HP segment, which was driven by India, China, Japan and other developing economies. The remaining 30% of the world tractor demand comes from more than 60 HP segment driven by the economies in Europe and North America. However, in the world market for 3PL systems, which was between USD 305 – USD 320 million in 2020, the contribution of more than 60 HP segment rises significantly on the back of higher price of 3PL in higher HP tractors. (Source: CRISIL Report) Accordingly, if the global tractor production, especially in geographies such as Europe and North America were to decline, our ability to supply 3PL systems could be impacted which could result in an adverse impact on our business, results of operations and financial condition.

**6. *Our dependence on our Subsidiaries, Uniparts USA Limited and Uniparts Olsen Inc., exposes us to significant risks.***

We currently conduct a significant portion of our operations, especially in the U.S., through UUL and UOI, which contributed ₹ 5,526.65 million, ₹ 4,742.85 million, ₹ 3,887.67 million and ₹ 3,463.07 million or 52.11%, 52.28%, 43.05% and 39.31% of our revenue from operations in Fiscal 2019, 2020 and 2021, and in the nine months ended December 31, 2021, respectively. We, therefore, rely on UUL and UOI for expanding our market share and business in the U.S for U.S. produced products and products from our Indian manufacturing facilities, and consequently our revenues, our free cash flows, investment income, financing proceeds, dividends and other permitted payments. Further, a significant diminution in the value of our investment in UOI may have an adverse effect on our financial condition, results of operations and prospects.

As UUL and UOI are separate and distinct legal entities, they have no obligation to pay dividends and may be restricted from doing so by law or contract, including applicable laws, charter provisions and the terms of its financing arrangements. We cannot assure you that UUL and UOI will generate sufficient profits and cash flows, or otherwise be able to pay dividends to us in the future. In addition, our financial condition may be adversely affected, should our equity stake in UUL and indirectly in UOI be diluted or if they cease to be our Subsidiaries.

**7. *We currently have certain open bills in the Export Data Processing and Monitoring System of the Reserve Bank of India.***

Exports from India are required to be conducted in accordance with the Foreign Exchange Management (Export of Goods and Services) Regulations, 2015. The Foreign Trade Policy (2015 – 2020) issued by the Directorate General of Foreign Trade which functions under the Ministry of Commerce and India, Department of India, Government of India is extended up till March 31, 2022. Exporters are required to realize and repatriate to India the full value of the goods, software and services exported within a stipulated period from the date of export, which is nine months from the date of the export and fifteen months in cases where the goods are exported to a warehouse established outside India. In view of COVID-19 pandemic, the Government of India increased the period of realization and repatriation to India of the amount representing the full export value of goods or software or services exported to a maximum of six months subject to certain conditions as prescribed by the RBI master direction dated April 1, 2020 for exports made up to or on July 31, 2020.

Pursuant to the circular of the Reserve Bank of India A.P. (DIR Series) Circular No. 03 Dated October 9, 2020, the procedure is laid out for cautioning/de-cautioning exporters in Export Data Processing Monitoring System (the “EDPMS”). Under the revised procedure, an exporter would be caution-listed by the Reserve Bank of India based on the recommendations of the AD bank concerned, depending upon the exporters track record with the AD bank and investigative agencies. We are not in the caution list for shipping bills outstanding for more than fifteen months. The EDPMS list received for our Company on January 2, 2022 and for Gripwel Fasteners Private Limited on January 1, 2022, includes certain unrealized bills for which we have received the payments and the AD bank is in process of clearing in the EDPMS system. After we exercised the “self-write off” option, 17 shipping bills are outstanding for our Company and our Subsidiary, GFPL, has 10 outstanding shipping bills. We cannot assure you that we will be able to exercise such and other options in respect of all our unrealized export bills and we cannot assure you that we will be able to realize our outstanding bills in a timely manner or at all.

**8. *We have compounded delayed filing of certain records with the Reserve Bank of India in the past.***

Our Company received a letter dated August 21, 2014 from the Reserve Bank of India (“RBI”) stating that four remittance transactions undertaken by our Company under the overseas direct investment mechanism in relation to Uniparts USA Limited (“UUL”) were reported with inordinate delay on June 4, 2014, June 2, 2014 and June 12, 2014 (for two transactions). There was also a delay in reporting the acquisition of UOI by UUL. The RBI in its letter stated that such delay was in contravention of regulation 6(2)(vi) of RBI notification no. FEMA120/RB-

2004 dated July 7, 2004, as amended, and advised our Company to compound the aforementioned delay. We have subsequently compounded this delay pursuant to an order dated March 16, 2015 of the RBI and payment of ₹ 2.53 million. While we believe that there has been no material non-compliance in the past, and that material information required for investors to make their investment decision in this Offer has been disclosed in this Draft Red Herring Prospectus, we cannot assure you that we will not be penalized for delay in regulatory filings in the future.

- 9. We have sustained negative cash flows from operations in the past. Any negative cash flows in the future would adversely affect our cash flow requirements, which may adversely affect our ability to operate our business and implement our growth plans, thereby affecting our financial condition.**

The following table sets forth certain information relating to our cash flows on a consolidated basis for the periods indicated.

Particulars	2019	Fiscal 2020	2021	Nine months ended December 31, 2021
	(₹ million)			
Net cash flow from/(used in) operating activities	(56.51)	1,330.67	1,527.55	354.43
Net cash flows (used in)/from investing activities	(1,081.92)	(101.11)	(157.38)	(245.11)
Net cash flows (used in)/from financing activities	1,248.58	(1,232.14)	(1,414.23)	(82.20)

Negative cash flows over extended periods, or significant negative cash flows in the short term, could materially impact our ability to operate our business and implement our growth plans. As a result, our cash flows, business, future financial performance and results of operations could be materially and adversely affected. For further information, see “*Management’s Discussion and Analysis of Financial Condition and Results of Operations – Cash Flows*” on page 382.

- 10. Industry information included in this Draft Red Herring Prospectus has been derived from an industry report prepared by CRISIL Limited exclusively commissioned and paid for by us for such purpose.**

We have used the report titled “*Global Market Assessment of 3PL and PMP Products in Agriculture and Construction Equipment*” dated April, 2022 by CRISIL Limited appointed on December 15, 2021, for purposes of inclusion of such information in this Draft Red Herring Prospectus, and exclusively commissioned and paid for by our Company for purposes of inclusion of such information in the Offer Documents at an agreed fees to be paid by our Company. Given the scope and extent of the CRISIL Report, disclosures are limited to certain excerpts and the CRISIL Report has not been reproduced in its entirety in this Draft Red Herring Prospectus. There are no parts, data or information (which may be relevant for the proposed issue), that has been left out or changed in any manner. The report is a paid report and is subject to various limitations and based upon certain assumptions that are subjective in nature. In addition, statements from third parties that involve estimates are subject to change, and actual amounts may differ materially from those included in this Draft Red Herring Prospectus. Also see, “*Certain Conventions, Presentation of Financial, Industry and Market Data – Industry and Market Data*” on page 15.

You should consult your own advisors and undertake an independent assessment of information in this Draft Red Herring Prospectus based on, or derived from, the Industry Report before making any investment decision regarding the Offer. For further information, see “*Industry Overview*” on page 111.

- 11. The current and continuing impact of the COVID-19 pandemic on our business and operations, including its impact on the demand for equipment in which components and parts manufactured and supplied by us are used, may have an adverse effect on our business, results of operations, financial condition and cash flows.**

The outbreak of the COVID-19 pandemic and its continuing impact, as well as government measures to reduce the spread of COVID-19 since March 2020, have impacted our operations and ability to sell our products within India as well as export of our products to international markets. The global spread of the COVID-19 pandemic has created significant volatility and uncertainty, as well as economic disruption. Our restated profit for the year / period was ₹ 695.97 million, ₹ 626.42 million, ₹ 923.86 million and ₹ 1,223.36 million in Fiscal 2019, 2020 and

2021, and in the nine months ended December 31, 2021, respectively. The impact of the pandemic on our business, operations and future financial performance have included and may in the future include the following:

- Temporary shutdown of our manufacturing facilities in India, for several weeks between March and June 2020. Our operations in the United States and Germany were permitted with implementation of strict safety and health protocols and limited physical presence. In addition, some or all of our workforce was not and may not be available due to quarantine, fear of being infected or other factors, and local, national or international transportation or other infrastructure may continue to be impacted, leading to delays or loss of production.
- Temporary closure of our distribution facilities, offices and decline in availability of workforce due to employees contracting the infection, rationalization of workforce, and restrictions on travel and movement due to lockdowns imposed by various state governments, affecting commute of employees to their places of work.
- Disruptions of the services we receive from third parties including our suppliers and transportation and logistics partners, due to sporadic availability of raw materials, increase in rate material costs, fluctuating and unpredictable demands, and disruptions in supply chain.
- We were required to invoke force majeure provisions under our contracts or undertake other similar measures with our customers and our suppliers.
- Disruptions in the operations of our customers and prospective customers, including as a result of travel restrictions and/or business shutdowns, uncertainty in the financial markets or other harm to their business and financial performance, leading to reduction in budgets, delayed purchasing decisions, longer sales cycles, increased inventories, extended payment terms, the timing of payments, and postponed or cancelled projects, all of which may negatively impact our business and operating results, including sales and cash flows. This could cause a reduction in our customers' demand for our products. We may have to decrease the selling price of our products to attract and retain customers if the demand for our products decreases. Our trade receivables were ₹ 1,453.58 million, ₹ 1,228.35 million, ₹ 1,675.32 million and ₹ 1,613.74 million in Fiscal 2019, 2020 and 2021, and in the nine months ended December 31, 2021, respectively.
- Regulatory restrictions relating to the pandemic interrupting our operations may also affect our ability to effectively manage our product inventory.
- Compliance with evolving government regulations, including with respect to social distancing measures and sanitization practices. Although we are currently in compliance with such guidelines, any failure in the future to fully comply or adhere to the measures and guidelines or any other similar regulations could lead to the imposition of penalties, fines or other sanctions, which could have an adverse impact on our business.
- Remote working arrangements for our employees, which may have a negative impact on our operations; the execution of our business plans; our ability to recruit, train, manage, and retain employees; the productivity and availability of key personnel and other employees necessary to conduct our business; and on third-party service providers who perform critical services for us, or otherwise cause operational failures due to changes in our normal business practices necessitated by the outbreak and related governmental actions. If a natural disaster, power outage, connectivity issue, or other event occurred that impacted our employees' ability to work remotely, it may be difficult or, in certain cases, impossible, for us to continue our business for a substantial period of time. The increase in remote working may also result in increased data security and fraud risks.

Additionally, there can be no assurance that we will be able to successfully achieve our expansion strategies in the event of subsequent waves of the pandemic in India that lead to additional restrictive measures or hamper overall economic recovery. In the event subsequent waves worsen or is not controlled in a timely manner, we may not be able to (i) manage our operations at its full capacity; and (ii) successfully implement our growth strategy. Further, while a majority of the eligible population under India's vaccine scheme has received at least a single dose of the COVID-19 vaccine with more than half of the eligible population now fully vaccinated, the likelihood of subsequent waves of the COVID-19 pandemic in India remains high especially against any new variants of COVID-19, for example, B.1.1.529 (Omicron) variant. Even though we have taken various initiatives

to raise awareness for COVID as well as implemented social distancing and hygiene measures in our manufacturing facilities, we cannot assure you that in the event of another COVID-19 wave additional restrictions will be put back in place or if another lockdown would be re-imposed to control the spread of COVID-19. The impact of the ongoing pandemic cannot be ascertained at this time, and while we cannot currently estimate the duration or future impact of the COVID-19 pandemic on our business or on the Indian or global economy, there is a likelihood that the effects could continue in future. Any intensification of the COVID-19 pandemic or any future outbreak of another highly infectious or contagious disease may adversely affect our business, results of operations and financial condition.

In addition, if our Key Managerial Personnel or a significant percentage of our workforce is unable to work due to COVID-19 illness, quarantine, limitations on travel or other government restrictions in connection with the COVID-19 pandemic, our operations may be negatively impacted. An outbreak or perceived outbreak of the COVID-19 pandemic connected to one or more of our manufacturing facilities could also cause negative publicity which causes customers to avoid our products, which could have a material adverse effect on our business, results of operations, financial condition, cash flows, reputation and prospects. Also see “*Restated Financial Statements – Annexure V – Note 50*” on page 341.

**12. We have entered, and will continue to enter, into related party transactions which may involve conflicts of interest. Further, our Promoters, Directors and Key Managerial Personnel have interests in us other than reimbursement of expenses incurred and normal remuneration or benefits.**

We have, in the ordinary course of our business, entered into transactions with certain related parties. We have in the past and may in the future purchase goods and samples from and sell goods to related parties. In addition, our Registered Office is leased by us from a member of our Promoter Group, Soni Holdings, which is a partnership firm in which our Promoter, Gurdeep Soni, is a partner. The details of related party transactions including as a percentage of revenue for Fiscal 2019, 2020 and 2021, and in the nine months ended December 31, 2021, are as follows:

	Fiscal 2019		Fiscal 2020		Fiscal 2021		Nine months ended December 31, 2021	
	Amount (₹ million)	Percentage of Revenue from Operations (%)	Amount (₹ million)	Percentage of Revenue from Operations (%)	Amount (₹ million)	Percentage of Revenue from Operations (%)	Amount (₹ million)	Percentage of Revenue from Operations (%)
Rent paid	1.87	0.02	1.84	0.02	1.99	0.02	1.49	0.02
Dividend paid	35.04	0.33	42.03	0.46	-	-	115.52	1.31
Sitting fees	1.43	0.01	0.46	0.01	1.12	0.01	0.7	0.01
Salary and allowances	2.16	0.02	-	-	-	-	-	-
Commission	0.6	0.01	0.3	0.00	-	-	-	-
KMP remuneration	122.51	1.16	122.8	1.35	104.15	1.15	97.35	1.11
ESOP granted to KMP	1.37	0.01	3.92	0.04	1.69	0.02	0.63	0.01
Revenue from Operations	<b>10,605.66</b>		<b>9,072.20</b>		<b>9,031.42</b>		<b>8,808.92</b>	

Further, our Promoters (who are also Directors of our Company), Gurdeep Soni and Paramjit Singh Soni, receive remuneration from our Subsidiaries GFPL and UUL, respectively. They are also entitled to statutory benefits upon termination of their employment with GFPL and UUL, respectively. One of our Directors, Herbert Coenen, receives remuneration and benefits as managing director of our Subsidiary, UIG and may be deemed to be interested to the extent that he has been granted ESOPs pursuant to ESOP 2007. Our Promoter and Director, Gurdeep Soni, is also interested in relation to lease rentals paid by the Company, in respect of the lease agreement dated January 17, 2014 entered into with Soni Holdings (Partnership Firm). Further, one of our Promoters, Gurdeep Soni is also a director of GCPL to whom the Company has granted a sub-lease pursuant to an agreement dated April 1, 2022. One of our Directors, Herbert Coenen is entitled to non-compete fee upon termination of his employment from our Subsidiary, UIG. In addition, our Key Managerial Personnel are also entitled to receive stock options pursuant to ESOP 2007. For further information, see “*Our Management – Interest of Directors*” and “*Our Promoter and Promoter Group – Interests of Promoters*” on pages 195 and 207, respectively.

While, in our view, all such related party transactions that we have entered into are conducted on an arm’s length basis, we cannot assure you that we could not have achieved more favourable terms had such arrangements not been entered into with related parties. Further, we cannot assure you that these or any future related party

transactions that we may enter into, individually or in the aggregate, will not have an adverse effect on our business, financial condition, results of operations and prospects.

**13. *We may be subject to work stoppages, strikes or other types of conflicts with our employees or contract workers in the future which may adversely impact our business and financial condition.***

Our manufacturing activities are labour intensive, require our management to undertake significant labour interface, and expose us to the risk of industrial action. Currently, in our U.S. and European operations (where none of our employees are represented by a labour union) and in our Indian operations (where we do not have any recognized trade unions), we have maintained a generally positive working environment.

However, in the past, our Company and our Subsidiaries have lost time on account of strikes or labour unrest in the past. In 2009, at our Noida facility, the factory management decided to withdraw the sale and attendance incentive scheme due to which workers at the factory went on strike from April 16, 2009 to April 24, 2009 and again from May 19, 2009 to June 22, 2009. Negotiations were conducted between the management and the workers in the presence of a magistrate and the Assistant Labour Commissioner, Noida, pursuant to which a settlement was reached and the strike was called off on June 22, 2009. On January 7, 2012, 80 workers at our Visakhapatnam facility went on a strike demanding absorption of 150 contract workers into the Company rolls. The strike was called off on January 13, 2012 pursuant to an agreement entered into by the management and the workers. In September 2014, workers at the Visakhapatnam facility went on a strike. Operations were shut for eight days and the strike was subsequently called off.

Although these incidents were resolved, we cannot ensure that we will not be subject to work stoppages, strikes or other types of conflicts with our employees or contract workers in the future. Further, we cannot ensure that our employees will not unionize in the future. Any such event, at our current facilities or at any new facilities that we may commission or acquire in the future, may adversely affect our ability to operate our business and serve our customers and impair our relationships with key customers and suppliers, which may adversely impact our business and financial condition.

**14. *Activities involving our manufacturing process can be dangerous and can cause injury to people or property in certain circumstances. Further, we regularly work with hazardous materials and activities in our operation can be dangerous, which could cause injuries to people or property. A significant disruption at any of our manufacturing facilities may adversely affect our production schedules, costs, sales and ability to meet customer demand.***

Our business involves complex manufacturing processes that can be dangerous to our employees. Although we employ safety procedures, including providing safety equipment on the shop floor, in the operation of our facilities and maintain what we believe to be adequate insurance, there is a risk that an accident or death may occur in any of our facilities. An accident may result in destruction of property or equipment, environmental damage, manufacturing or delivery delays, or may lead to suspension of our operations and/or imposition of liabilities. Any such accident may result in litigation, the outcome of which is difficult to assess or quantify, and the cost to defend litigation can be significant. As a result, the costs to defend any action or the potential liability resulting from any such accident or death or arising out of any other litigation, and any negative publicity associated therewith, may have a negative effect on our business, financial condition, results of operations and prospects. While we maintain legally mandated insurance policies such as accident and medical insurance policies for our employees and a public liability insurance, we cannot assure you that the coverage under such policies will be sufficient to cover loss sustained or that an affected employee or third party will not additionally seek legal recourse against us.

In particular, if operations at our manufacturing facilities were to be disrupted as a result of any significant workplace accident, equipment failure, natural disaster, power outage, fire, explosion, terrorism, adverse weather conditions, labour dispute, obsolescence or other reasons, our financial performance may be adversely affected as a result of our inability to meet customer demand or committed delivery schedules for our products. For instance, in August 2005, a warehouse owned by UUL located in Augusta, Georgia collapsed during construction. During this period, warehousing operations of UUL were carried out from a public warehouse. We incurred warehousing charges for use of the public warehouse as well as additional legal fees in this regard. Further, in October 2013, a fire affected the heat treatment area of our Visakhapatnam facility. The delivery schedule to our customers during the period from November 2013 to March 2014 was adhered to by outsourcing the heat treatment process to third parties and supplies to our customers were fulfilled without any stoppages. Our Company incurred expenses of ₹ 13.06 million towards outsourcing of the heat treatment process on account of this fire and also incurred additional

freight cost to meet our customers' delivery schedules. Since that time, we have completed repairs at the Visakhapatnam facility heat treatment area.

Interruptions in production may also increase our costs and reduce our sales and may require us to make substantial capital expenditures to remedy the situation or to defend litigation that we may become involved in as a result, which may negatively affect our profitability, business, financial condition, results of operations and prospects.

Our operations are also subject to operating risks associated with OHV component manufacturing, including related to handling and storage of raw materials used in our manufacturing processes. Our operations involve handling hazardous materials such as propane and high speed diesel, which can cause accidents during the manufacturing process resulting in serious injuries or death of employees or other persons, if improperly handled, and cause damage to our properties and the properties of others. Despite compliance with requisite safety requirements and standards, our operations are subject to significant hazards, including:

- explosions;
- fires;
- mechanical failures and other operational problems;
- inclement weather and natural disasters;
- discharges or releases of hazardous substances, chemicals or gases; and
- other environmental risks.

There has been three instances of fires over the last three Fiscals and in the nine months ended December 31, 2021. UOI had an incident of fire in the plant and suffered property damages during the previous year. The insurance claim for the same was settled during Fiscal 2021. During Fiscal 2021, the UOI incurred expenses related to fire amounting to USD 1.01 million (₹ 75.25 million) and USD 3.08 million (₹ 218.34 million) in Fiscal 2020 and has recognised insurance claim recoveries amounting to USD 3.21 million (₹ 238.36 million) in Fiscal 2021 and USD 3.27 million (₹ 231.79 million) in Fiscal 2020. In addition, there was a fire at the facility of our other Subsidiary, GFPL, occurred in August 2020 and the insurance claim has been settled for an amount of ₹ 453,000. During Fiscal 2020, there were two incidents of fire at our facility at Visakhapatnam, Andhra Pradesh and at our facility at Ludhiana, Punjab and the claims amounting to ₹ 10.83 million have been settled and recognised during Fiscal 2021.

The occurrence of any of these hazards could result in a suspension of operations and the imposition of civil or criminal liabilities. The loss or shutting down of our facilities could disrupt our business operations and adversely affect our results of operations, financial condition and reputation. We may also face claims and litigation, in India or overseas, filed on behalf of persons alleging injury predominantly as a result of occupational exposure to hazards at our facilities. If these claims and lawsuits, individually or in the aggregate, are resolved against us, our business, results of operations and financial condition could be adversely affected.

**15. *A failure to comply with financial and other restrictive covenants imposed on us under our financing agreements may cause us to default on these agreements, which may adversely affect our ability to conduct our business and operations.***

As on December 31, 2021, our total long-term (non-current) borrowings from banks, financial institutions and related parties amounted to ₹ 15.14 million, while our total short term (current) borrowings from banks including current maturities of term loans amounted to ₹ 1,394.44 million. For further information on our indebtedness, see "**Financial Indebtedness**" and "**Restated Financial Statements – Annexure V – Note 13**" on pages 352 and 268, respectively. Our leverage has several important consequences, including the following:

- a portion of our cash flow from operations will be used towards repayment of debt, which will reduce the availability of cash to fund working capital requirements, capital expenditures, acquisitions and other general corporate purposes;
- our borrowing cost and the existence of encumbrances on a significant portion of our immovable properties may constrain our ability to raise incremental financing in the future, at commercially reasonable terms. For instance, our facilities in Noida are mortgaged in favour of our lenders, in connection with our secured borrowings. While there have not been any instances in the past of enforcement of security interests owing to an event of default in relation to any properties mortgaged by us in favour of our lenders under any of our financing agreements, which have restricted our ability to operate our business at such locations, in the event of enforcement of an event of default in connection with such secured borrowings (which is not waived or cured) in the future, our ability to continue to operate our business at such locations may be



restricted. For further information in relation to security interest created in favour of our lenders, see “*Financial Indebtedness*” and “*Restated Financial Statements – Annexure V – Note 13*” on pages 352 and 268, respectively; and

- fluctuations in interest rates may affect our cost of borrowing, as all or a substantial part of our borrowings is at floating rates of interest.

In particular, our financing agreements require us to maintain certain financial ratios including debt-equity ratio, and to obtain the consent of, or to intimate, our lenders for certain actions including prepayment of any outstanding borrowings, effecting any change in shareholding, directorship or management of our Company, raising further loans, issuance of guarantees by our Company, extending loans or advances to affiliates, or making any material amendments in our Memorandum and Articles of Association or in the constitutional documents of our Subsidiaries. Our failure to comply with financial or restrictive covenants or periodic reporting requirements or to obtain our lenders’ consent to take restricted actions in a timely manner or at all may result in the declaration of an event of default by one or more of our lenders, which may accelerate repayment of the relevant loans or increase applicable interest rates or cause the termination of our credit facilities or trigger the invocation of security under our financing arrangements or cross-defaults under certain of our other financing agreements. For instance, due to an inability to maintain certain financial ratios in the past, we were charged additional interest with effect from March 2009 until July 31, 2009 (excluding for June 2009), under the terms of a foreign currency denominated loan facility sanctioned to our UOI. However, the defaults were subsequently waived pursuant to an amendment agreement and this facility was repaid in full by UOI and the security was released in April 2013.

In addition, UIG, our Subsidiary in Germany has obtained a loan for an amount of € 600,000 from UEBV, our Subsidiary in Netherlands, pursuant to a loan agreement. Under the terms of the loan agreement, UIG has no obligation to repay the amount to UEBV and can repay when it has sufficient funds available to repay the loan amount. Further, UEBV is unable to force repayment of the loan. There can be no assurance that the loan amount will be repaid by UIG in a timely manner or at all.

An event of default may also affect our ability to raise additional funds or renew maturing borrowings to finance our existing operations and pursue our growth initiatives. The termination of, or declaration or enforcement of default under, any financing agreement (if not waived or cured) may have an adverse effect on our business, financial condition, results of operations and prospects.

**16. *Failure to obtain or renew necessary regulatory approvals may adversely affect our business and financial condition.***

We are required to obtain various regulatory approvals and registrations for our operations, including consents from the local pollution control boards in India to establish and operate our manufacturing facilities in India, and registrations with the relevant tax and labour authorities in India amongst others as well as in the United States, some of which may expire in the ordinary course and for which we would be required to make applications for renewal from time to time. In the past, there have been delays in obtaining renewals even where we submitted applications within the prescribed time. For instance, in respect of our approval for collection, reception, treatment, storage, transport and disposal of hazardous waste for our SKG facility in Ludhiana, our application for renewal was returned twice for lack of certain documents resulting in a 16-month delay in renewal. While our application was finally accepted, our approval is currently valid, and we have noted the additional documentation requested for so as to ensure the same is submitted in our future applications, we cannot assure that we will not experience delays in renewing our material approvals going forward.

In addition, our operations also require us to obtain other approvals and permits including for use of utilities. In the past, our applications for use of certain utilities have been rejected. Specifically, our August 11, 2018 application for abstraction of ground water for use in our B – 208, Noida, Uttar Pradesh facility was rejected by the Central Ground Water Board, Ministry of Water Resources for failing to submit a certificate of non-availability of water from the local governmental water supply agency along with our application. We re-submitted our application on November 14, 2018, and thereafter submitted an application dated March 14, 2022, with the Ground Water Department, Uttar Pradesh. Subsequently, on March 21, 2022, GFPL made an application to the Ground Water Department, Uttar Pradesh for abstraction of ground water for its manufacturing facility in Noida, Uttar Pradesh. As on the date of this Draft Red Herring Prospectus, we are yet to receive the no objection certificates for the use of ground water at our respective facilities in Noida. Further, we were unsuccessful in a recent attempt to obtain registration of the wordmark “GRIPWEL in the United States.

Failure to obtain and maintain any required approvals and registrations may have an adverse effect on our business, financial condition, results of operations and prospects. Further, our approvals and registrations are subject to numerous conditions (for instance, including periodic reporting or audit requirements), some of which may require us to undertake substantial compliance-related expenditure. Breach or non-compliance with specified conditions may result in the suspension, withdrawal or termination of our approvals and registrations or the imposition of penalties by the relevant authorities.

A suspension, cancellation or refusal to extend our approvals and registrations may require us to cease production at some or all of our manufacturing facilities (or may affect other aspects of our operations), which may have an adverse effect on our business, financial condition, results of operations and prospects.

**17. We may face an adverse impact on our sales and earnings as a result of risks associated with our international sales and multi-location operations.**

We have operations and assets located in India, the U.S. and Europe. In Fiscal 2019, 2020 and 2021, and in the nine months ended December 31, 2021, our International Sales amounted to ₹ 8,830.05 million, ₹ 7,580.05 million, ₹ 7,255.36 million and ₹ 7,175.29 million, respectively, amounting to 83.26%, 83.55%, 80.33% and 81.45%, respectively, of our revenue from operations, in such periods. The table below sets forth our geography-wise revenue across product segments for the periods indicated:

Particulars	Fiscal 2019		Fiscal 2020		Fiscal 2021		Nine Months ended December 31, 2021	
	(₹ million)	Percentage of Revenue from Operations (%)	(₹ million)	Percentage of Revenue from Operations (%)	(₹ million)	Percentage of Revenue from Operations (%)	(₹ million)	Percentage of Revenue from Operations (%)
<b>Americas</b>								
3PL	1,883.85	17.76	1,832.04	20.19	1,898.14	21.02	1,814.37	20.60
PMP	4,034.15	38.04	3,348.00	36.90	2,401.86	26.59	2,126.85	24.14
PTO applications	48.28	0.46	31.76	0.35	21.30	0.24	35.77	0.41
Fabrication	1.98	0.02	-	0.00	0.91	0.01	1.06	0.01
Hydraulic cylinders	8.15	0.08	4.54	0.05	6.84	0.08	4.59	0.05
<b>Europe<sup>(1)</sup></b>								
3PL	1,312.09	12.37	1,060.19	11.69	1,395.06	15.45	1,399.97	15.89
PMP	503.81	4.75	491.95	5.42	554.10	6.14	639.94	7.26
Fabrication	38.27	0.36	58.44	0.64	73.33	0.81	79.92	0.91
PTO applications	44.58	0.42	32.43	0.36	57.74	0.64	53.36	0.61
<b>India</b>								
3PL	1,291.33	12.18	1,038.61	11.45	1,306.82	14.47	1,173.19	13.32
PMP	23.58	0.22	90.72	1.00	115.02	1.27	92.02	1.04
Fabrication	29.08	0.27	18.74	0.21	9.84	0.11	6.37	0.07
PTO applications	0.52	0.00	-	-	2.05	0.02	-	-
<b>Japan</b>								
PMP	309.59	2.92	300.98	3.32	289.60	3.21	290.27	3.30
3PL	176.65	1.67	121.73	1.34	119.80	1.33	119.20	1.35
<b>Asia-Pacific<sup>(2)</sup></b>								
3PL	174.79	1.65	113.92	1.26	154.86	1.71	159.20	1.81
PMP	44.89	0.42	54.96	0.61	10.58	0.12	21.64	0.25
PTO applications	0.02	0.00	-	-	-	-	-	-
<b>Rest of the world<sup>(3)</sup></b>								
3PL	193.39	1.82	113.15	1.25	191.87	2.12	239.01	2.71
Hydraulic cylinders	3.96	0.04	2.11	0.02	1.03	0.01	-	-
PMP	50.94	0.48	36.46	0.40	26.10	0.29	30.98	0.35
PTO applications	1.27	0.01	0.29	0.00	1.05	0.01	1.19	0.01

Notes:

(1) Europe includes Austria, Belgium, Czech Republic, Denmark, France, Germany, Hungary, Ireland, Italy, Netherlands, Poland, Spain and United Kingdom

- (2) *Asia-Pacific includes China, Indonesia, Israel, Korea, Thailand, Turkey and Yemen*  
(3) *Rest of the world includes Australia, Brazil, Mexico, New Zealand, South Africa and Zambia*

A key part of our long-term strategy is to increase our manufacturing, distribution and sales presence in international markets. We are affected by risks inherent in International Sales and operations, including:

- economic cycle and demand for our products in the international markets;
- currency exchange rate fluctuations;
- regional economic or political uncertainty;
- currency exchange controls;
- differing accounting standards and interpretations;
- differing labour regulations;
- differing domestic and foreign customs, tariffs and taxes;
- current and changing regulatory environments;
- difficulty in staffing and managing widespread operations;
- coordinating and interacting with local representatives and counterparties to fully understand local business and regulatory requirements; and
- availability and terms of financing.

Selling products in international markets and maintaining and expanding international operations require significant coordination, capital and resources. Moreover, the length and complexity of our internal production chain make us vulnerable to numerous risks, many of which are beyond our control, which may cause significant interruptions or delays in production or delivery of our products to our customers.

To the extent that we are unable to effectively manage our global operations and risks such as the above (in particular, as we implement our strategy to enter into new markets where we do not have local knowledge and resources), we may be unable to grow or maintain our sales and profitability, or we may be subject to additional unanticipated costs or legal or regulatory action. As a consequence, our business, financial condition, results of operations and prospects may be adversely affected.

**18. *Our reliance on third parties for certain aspects of our business, including raw material suppliers, transporters of our raw materials and products and logistic / warehouse service providers, exposes us to certain risks.***

We rely on third parties for the supply of raw materials, components, contract labour and power required for the manufacture of our products, as well as for performance of certain processes and services carried out at our manufacturing, warehousing and office premises including waste management and facility management functions. Our ability to identify and build relationships with reliable vendors worldwide contributes to our growth and our successful management of our inventory as well as other aspects of our operations. Although we have an in-house vendor rating process, we cannot assure you that this process entirely eliminates the risk of un-reliable vendors. Our raw material and component suppliers may fail to consistently deliver products of acceptable quality and within stipulated schedules, or the contractors to whom we have outsourced certain processes and services at our manufacturing, warehousing or office premises may not fulfil specified performance standards, which may adversely affect our operations. We may be required to replace a vendor if its products or services do not meet our safety, quality or performance standards or if a vendor should unexpectedly discontinue operations due to reasons beyond its or our control (including financing constraints caused by credit market conditions).

Factors such as the financial instability of suppliers, vendors' non-compliance with applicable laws, trade restrictions, labour disputes, currency fluctuations, changes in tariff or import policies, severe weather, political uncertainty, terrorist attacks and transport capacity and cost may disrupt our supply chains, which may result in increased costs or delivery delays. Further, increase in competition and/or our competitors having established operations and long-term relationships with suppliers may see us facing challenges to secure adequate supply of raw materials or may increase our overall cost of raw materials. Therefore, there is no assurance that third party suppliers will be able to meet their contractual commitments to us, or that we will not be required to incur additional costs to remedy any deficiencies in their services or to obtain alternative sources of supply in the event that our contracted suppliers should default or be delayed in their performance. A significant disruption in supply of raw material, contract labour, power or third party services for our warehousing operations may, in turn, disrupt our operations and adversely affect our inventory management, business and financial condition, at least until alternative sources of supply of goods and services are arranged.

We also use, and intend to continue to use, third party transporters for the supply of our raw materials and for deliveries of our products to our customers. Increased transportation costs as well as interruptions due to strikes by members of truckers' unions or shipping delays or adverse weather conditions or inadequate transport infrastructure may, to the extent that our losses are not covered by insurance, adversely affect the timely receipt of our raw materials as well as products, resulting in an adverse impact on our business, financial condition, results of operations and prospects.

**19. We have significant amounts of short term (current) borrowings. If we experience insufficient cash flows to enable us to fund working capital requirements or to service our short term (current) borrowings, there may be an adverse effect on our business, financial condition, results of operations and prospects.**

Our business requires a high amount of working capital, primarily on account of high inventory levels and trade receivables owing to multiple levels of operations, including backward integrated manufacturing operations as well as forward integrated warehousing. Hence, we have availed a significant amount of short term (current) borrowings to enable us to finance our operating cycle. The details of our inventory and trade receivables, including the number of days for inventory and trade receivables in Fiscal 2019, 2020, 2021 and the nine months ended December 31, 2021, is as follows:

Particulars	Fiscal 2019	Fiscal 2020	Fiscal 2021	Nine months ended December 31, 2021
(₹ million, except day-wise data)				
Inventory (closing)	3,674.66	3,529.17	3,390.79	4,545.71
Trade receivables	1,453.58	1,228.35	1,675.32	1,613.74
Inventory days <sup>(1)(2)</sup>	126	145	137	142
Receivables days <sup>(3)(4)</sup>	50	49	68	50

Notes:

(1) Where inventory days for complete Fiscal = closing inventory / revenue from operations x 365

(2) Where inventory days for the nine months ended December 31, 2021 = closing inventory / revenue from operations x 275

(3) Where receivable days for complete Fiscal = closing receivables / revenue from operations x 365

(4) Where receivable days for the nine months ended December 31, 2021 = closing receivables / revenue from operations x 275

Set forth below are details of our short term (current) borrowings as a percentage of total borrowings and our interest costs on such short term (current) borrowings as a percentage of our profit.

Particulars	Fiscal 2019	Fiscal 2020	Fiscal 2021	Nine months ended December 31, 2021
(₹ million, except percentages)				
Short term (current) borrowings (working capital)	2,816.75	2,158.60	1,141.34	1,335.33
Total borrowings	3,456.28	2,564.97	1,277.77	1,409.58
Short term (current) borrowings as percentage of total borrowings (%)	81.50	84.16	89.32	94.73
Interest costs on short term (current) borrowings	131.23	114.41	39.59	19.51
Restated Profit for the Year/ Period	695.97	626.42	923.86	1,223.36
Interest cost on short term (current) borrowings as a percentage of profit for the relevant year/ period (%)	18.86	18.26	4.29	1.59

For further information on our short term (current) borrowings, including the key terms of agreements with our lenders for such short term (current) borrowings, see "**Financial Indebtedness**" on page 352.

If a significant customer defaults on or delays payment on any order to which we have devoted significant resources, it may affect our profitability and liquidity and decrease capital resources available to us for other uses, including our obligations under the credit facilities granted to us by our lenders as well as our ability to fund payables to our suppliers, which may further result in reduced availability of raw materials and/or increased raw material costs. If we are unable to finance our working capital needs or to secure other financing, when needed, on acceptable commercial terms, it may adversely affect our business, financial condition, results of operations and prospects.

**20. *We are subject to risks arising from interest rate fluctuations which could adversely affect our results of operations, planned expenditures and cash flows.***

As of December 31, 2021, 94.73% of our indebtedness, excluding bill discounting, was at floating interest rates while 5.27% of our indebtedness was at fixed interest rate or hedged against interest rate risks. For further information on our indebtedness, see “*Financial Indebtedness*” and “*Restated Financial Statements – Annexure V – Note 13*” on pages 352 and 268, respectively. If the interest rates of our existing or future borrowings increase significantly, our cost of funds will increase. A further increase in interest rates may have an adverse effect on our results of operations and financial condition. While we could consider refinancing the loan or hedging interest rate risks in appropriate cases, there can be no assurance that we will be able to do so on commercially reasonable terms or at all, that our counterparties will perform their obligations, or that these agreements, if entered into, will protect us adequately against interest rate risks. Further, if such arrangements do not protect us adequately against interest rate risks, they would result in higher costs.

**21. *If we are unable to retain and hire Key Managerial Personnel or to maintain good relations with our workforce, our business and financial condition may be adversely affected.***

Our ability to provide high-quality products and services and to manage the complexity of our business depends, in part, on our ability to retain and attract skilled personnel in the areas of management, product engineering, design, manufacture, servicing, sales, IT and finance. Competition for such personnel is intense and the cost of retaining or replacing such personnel may affect our profitability. In addition, our strategies for growth have placed, and are expected to continue to place, increased demands on our management’s and employees’ skills and resources. Our future performance would depend on the continued service of our management, key managerial personnel and our employees, and the loss of any Key Managerial Personnel and the inability to find an adequate replacement may impair our relationship with key customers and our level of technical expertise, which may adversely affect our business, financial condition, results of operations and prospects. In Fiscal 2019, 2020 and 2021, and in the nine months ended December 31, 2021, our staff attrition was 101, 78, 79 and 70 employees, respectively, and our attrition rate was 12.04%, 10.92%, 11.60% and 10.45%, respectively. Further, the attrition of our Key Managerial Personnel was one, nil, one and one employee, respectively, and the attrition rate for our Key Managerial Personnel was 33.33%, nil, 33.33% and 33.33%, respectively, in Fiscal 2019, 2020 and 2021, and in the nine months ended December 31, 2021. In particular, we rely on the experience and industry relationships of our Promoter, Chairman and Managing Director, Gurdeep Soni, Promoter, Executive Director and Vice Chairman, Paramjit Singh Soni, our Director, Herbert Coenen, and our Group Chief Operating Officer, Sudhakar Kolli. Further, we also maintain a directors and officers’ liability policy. Should the involvement of such persons in our business reduce, or should our relationship with these persons deteriorate for any reason in the future, our business, financial condition, results of operations and prospects may be adversely affected.

**22. *An adverse determination in a significant product liability or performance improvement claim or significant replacement costs may adversely affect our business, financial condition, results of operations and prospects.***

The use of our products, often under extreme conditions, carries an inherent risk of product liability claims arising from personal injury, death or property damage due to equipment failure, work accidents, fire or explosion, if our products are defective or are used incorrectly by our customers (or by their customers, who are the end-users).

The warranty arrangements or conditions for our products are covered under the general purchase terms and conditions of our customers. To the extent that such OEM customers provide a warranty to their end users and incur warranty costs for non-conformity of their products to agreed specifications or standards, our supply arrangements with our OEM customers typically allow us to review warranty claims in order to determine if the failure was caused by a manufacturing defect in our products. If it is determined that the failure was on account of a manufacturing defect in our products, we are typically required to promptly correct or replace those defective products at our own expense and prepare a written corrective action plan, failing which, we may be required to reimburse our OEM customers at part acquisition cost, with additives to cover administrative, labour, material and other such costs. The standard warranty period for our products is 12 to 24 months but, in the case of certain specified types of equipment in which our components are used, may extend to 36 months or longer. Where we have not entered into warranty agreements with certain of our customers, our customers can raise debit notes equal to or more than the selling price of the products that are rejected and physically returned to us or scrapped at the customer’s end after our approval.

There is a risk that we may incur higher than expected warranty or performance improvement costs or become aware of a defective or underperforming product. Further, we may be subject to claims arising from alleged, suspected or actual defects in the products that we manufacture, within the warranty periods extended by us, which may require us to conduct product recalls, or we may be required or requested to participate in product recalls conducted by our OEM customers due to alleged, suspected or actual defects in equipment manufactured by them for their own customers. In Fiscal 2015, one of our customers notified us of a warranty claim relating to a specific part supplied by us which had not been properly heat treated and thus allegedly caused defects in the assembly ultimately sold by such customer to its end users. We had outsourced this specific part for heat treatment. We were first notified of a potential claim in August 2014, the amount of which was then unknown. Based upon the data provided to the Company by such customer in 2015, the customer experienced the majority of claims relating to this item in 2012 and 2013. We have subsequently received reimbursement from the vendor to whom we had outsourced the heat treatment. In addition, there have been two instances of product liability claims in 2021. There was one product fault claim in the United States for an amount of USD 5,814 (₹ 0.43 million) that was settled by insurance, while there was another product fault claim in Germany which is currently under review.

While we maintain insurance coverage, including a comprehensive general liability policy, which includes product liability insurance covering product recall expenses, product guarantee and financial losses, in keeping with what we believe to be the industry standard, we cannot assure you that we are sufficiently insured against punitive damage awards. In the event that any significant product liability, performance improvement or replacement claims are brought against us, which are not entirely covered by insurance or result in recoveries in excess of our insurance coverage, it may adversely affect our business, financial condition, results of operations and prospects. Further, despite insurance coverage, in the event of any future accident or liability involving our products, our customers may delay or withhold payments to us and/or seek to enforce warranty or performance improvement claims against us, and which in turn may, to that extent, diminish our reputation among our customers, suppliers, lenders, investors and the public, making it difficult for us to operate our business and compete effectively, which may adversely affect our business, financial condition, results of operations and prospects.

**23. *Failure or disruption of our IT and/or ERP systems, or cybercrimes or similar disruptions, may adversely affect our business, financial condition, results of operations and prospects.***

We have implemented various information technology (“IT”) and/or enterprise resource planning (“ERP”) solutions to cover key areas of our operations. For instance, we have implemented ERP systems across our operations in the U.S., Germany and our Visakhapatnam, Noida and Ludhiana facilities in India, to consolidate data and other key performance parameters at the global level. Other significant ERP solutions include systems designed to provide data security and to allow for collaboration of information across the network, as well as supply chain solutions to cover critical processes in relation to customers and suppliers across our manufacturing facilities. Further, we are dependent on technology in relation to customer order management and dispatches, production planning and reporting, manufacturing processes on the shop floor, financial accounting and scheduling raw material purchase and shipments. We rely on our IT infrastructure to provide us with connectivity and data backup across our locations and functions. While the ERP solutions that we have implemented have enabled us to improve our working capital cycles, despite an increase in our Warehouse Sales, we can provide no assurance that we will be able to do so in the future.

We believe that we have deployed adequate IT disaster management systems including data backup and retrieval mechanisms, in all our facilities. However, any failure or disruption in the operation of these systems or the loss of data due to such failure or disruption (including due to human error or sabotage) may affect our ability to plan, track, record and analyze work in progress and sales, process financial information, manage our creditors, debtors and hedging positions, or otherwise conduct our normal business operations, which may increase our costs and otherwise adversely affect our business, financial condition, results of operations and prospects.

In addition, our systems and proprietary data stored electronically may be vulnerable to ransomware attacks, computer viruses, cybercrime, computer hacking and similar disruptions from unauthorized tampering. If such unauthorized use of our systems or those of our customers were to occur, data related to our customers, products, product development pipeline, payment systems and other information could be compromised. For instance, in Fiscal 2018, certain of our customers received fraudulent emails from unauthorized third parties requesting them to change their existing payment details for the Company. While we did not suffer any loss as a result of such fraudulent emails, the occurrence of such events could adversely affect our relations with our customers, our business, financial condition and results of operations. For further information on the criminal complaints filed by our Company see “*Outstanding Litigation and Other Material Developments – Litigation Involving our Company – Litigation by our Company – Criminal Proceedings*” on page 390.

**24. *If we are unable to successfully identify and integrate acquisitions, our growth strategy and prospects may be adversely affected.***

We have in the past relied on inorganic growth as a key part of our growth strategy (including our strategy of examining opportunities for forward integration, expanding into complementary product verticals, new customer acquisition and exploring newer markets where we do not currently have a presence). We may seek to identify and complete acquisitions and investments that meet our strategic and financial return criteria. However, there can be no assurance that we will be able to identify suitable acquisition or investment targets, arrange adequate financing on commercially reasonable terms for planned acquisitions or investments, negotiate commercially reasonable terms for the acquisition of, or investment in, target companies or businesses, integrate their operations with our own, retain key employees and customers critical for the target entity and realize our expectations and strategic objectives from planned acquisitions and investments. We cannot assure you that our acquisitions will prove value accretive.

Strategic acquisitions and investments involve several risks, including the following:

- difficulties in arranging adequate financing (whether debt or equity or a combination thereof) on commercially reasonable terms, to complete our planned investments or acquisitions in the budgeted time, cost and manner;
- difficulties or delays in obtaining lender consents required under our financing agreements, prior to undertaking any planned investments or acquisitions;
- potential assumption of unanticipated liabilities and contingencies, including claims from current or former creditors, customers, suppliers, employees and other third parties;
- potential adverse short-term effects on operating results through increased costs or otherwise;
- unforeseen difficulties in extending disclosure and other internal controls and procedures over financial and other reporting and in performing the required assessment and remediation at the newly acquired business;
- unforeseen difficulties in assimilating the operations, personnel, management information systems and other administrative systems of acquired businesses and in transitioning existing operations, users and customers onto our platforms;
- potential disagreements with strategic partners and collaborators;
- diversion of management time and focus, and managing the realignment of our management resources;
- possible impairment of relationships with customers, suppliers and employees of acquired businesses as a result of changes in ownership and management;
- unforeseen difficulties in complying with regulatory requirements that may be applicable, in case the target is in a different jurisdiction; and
- difficulties in repatriating funds in case acquisition is made in a jurisdiction which has such restrictions.

For instance, in 2007 we had entered into a joint venture with Kramp Groep B.V. (“**Kramp**”) pursuant to which we had invested in Uniparts Kavee B.V. (“**Kavee**”), primarily for the production of hydraulic cylinders. We sold our entire interest in Kavee to Kramp with effect from April 1, 2012. We incurred a net loss of Euro 275,001 (₹ 17.76 million on cost basis) on account of this transaction. We believe we have benefited from this transaction due to exposure we gained by our involvement in a new product line as well as industry knowledge of the European markets, although we believe that the long-term focus of Kavee on this product and its customer strategy, including its serviceability, was not aligned to our overall focus and strategy and hence we divested our equity stake in the venture. There can be no assurance that we will be able to succeed in similar ventures in the future.

While we believe that strategic acquisitions can improve our competitiveness and profitability, we may be unable to complete planned acquisitions or investments on schedule or as budgeted or at all, or our due diligence processes may fail to identify all the challenges and liabilities involved in the acquisition or investment. Further, we may be required to expend significant resources and management attention towards such strategic acquisitions which may not fructify. There can be no assurance that any businesses acquired or invested in will perform in accordance with our expectations or that our judgments concerning the value, strengths and weaknesses of businesses acquired or invested in will prove to be correct. Any such risks mentioned above, may reduce our profitability, increase our operating costs, interest and amortization expenses, require us to obtain additional debt and/or equity financing, dilute our goodwill and brand value or otherwise have an adverse effect on our business, financial condition, results of operations and prospects.

**25. *We outsource a portion of our manufacturing processes to certain sub-contractors, which presents numerous risks.***

The processing of some of our intermediate products in India and the U.S. is outsourced. Some of the outsourced processing is undertaken within the premises of our facilities. We depend on the expertise of such sub-contractors and rely on them to provide satisfactory products and levels of service. Thus, our manufacturing and warehousing model presents numerous risks, including the following:

- interruptions to the operations of our sub-contractors due to strikes, lockouts, work stoppages or other forms of labour unrest, breakdown or failure of equipment as well as accidents;
- failure by our sub-contractors to comply with applicable law and the directives of relevant governmental authorities;
- insufficient quality controls or failures in the quality controls of our sub-contractors;
- significant adverse changes in the financial or business conditions of our sub-contractors;
- performance by our sub-contractors below expected levels of output or efficiency;
- the possibility that our competitors will engage our sub-contractors, directly or indirectly, and thereby reduce the manufacturing capacity available to us;
- any inability on our part to renew existing agreements with or find replacements for existing sub-contractors;
- misappropriation of intellectual property by our sub-contractors; and
- sub-standard products impacting our production schedules or adversely impacting our relationships with key customers.

We have in the past been subject to a warranty claim in respect of a component which had been outsourced. In Fiscal 2015, one of our customers notified us of a warranty claim relating to a specific part supplied by us which had not been properly heat treated and thus allegedly caused defects in the assembly ultimately sold by such customer to its end users. We had outsourced this specific part for heat treatment. We settled this claim with the customer in 2016.

We cannot assure you that such incidents will not occur in the future or that we will be successful in continuing to receive uninterrupted supply of intermediate products from our sub-contractors at prices acceptable to us, or at all. Any disruption or inefficiencies in the supply chain network may adversely affect our business and results of operations.

**26. *Our quarterly results may fluctuate significantly due to seasonality which could have a negative effect on the price of our Equity Shares.***

Our quarterly results of operations may fluctuate significantly as a result of a variety of factors, including the seasonal nature of the sectors in which we operate. For instance, a significant portion of our operating profit and cash flows have historically been realized during the first and fourth quarters of each year, primarily due to seasonality and weather conditions. As a result, our financial statements for consecutive quarters may not be directly comparable with each other. Moreover, any significant disruption in our operations or other factors that result in a significant shortfall compared with our expectations for the first and fourth quarters could, consequently, result in a significant shortfall in sales and operating cash flows for the full year.

**27. *We are subject to various laws and regulations in jurisdictions where we operate, including environmental and health and safety laws and regulations, which may subject us to increased compliance costs, which may in turn result in an adverse effect on our financial condition.***

Our operations are subject to central, state, local and foreign laws and regulations relating to the protection of the environment and occupational health and safety, including those governing the generation, handling, storage, use, management, transportation and disposal of, or exposure to, environmental pollutants or hazardous materials resulting from our manufacturing processes. For instance, we require approvals under the Water (Prevention and Control of Pollution) Act, 1974 and the Air (Prevention and Control of Pollution) Act, 1981, in order to establish and operate our manufacturing facilities in India and are subject to inspections from the relevant authorities in order to maintain such approvals. On October 18, 2021, we received a show-cause notice from the Andhra Pradesh Pollution Control Board pursuant to an inspection conducted on September 4, 2021, alleging, amongst other things, certain non-compliances in relation to maintaining provisions for port holes, power supply, non-installation of air pollution control equipment and lack of sufficient number of separate energy meters. While we have submitted a compliance report dated December 24, 2021, and pursuant to a letter dated March 21, 2022, requested



the AP PCB to provide a further four months to complete such actions and submit the final compliance report, the matter remains pending, and we cannot assure you that we will not be subject to future action or penalties in this respect. For further information, see “***Outstanding Litigation and Other Material Developments – Litigation Involving our Company – Litigation against our Company – Actions taken by regulatory and statutory authorities***” on page 389.

Our operations, facilities and properties in the United States and Germany are also subject to evolving international, local and federal laws including the Foreign Corrupt Practices Act of 1977 and Foreign Account Tax Compliance Act of 2010, state and local environmental and occupational health and safety laws and regulations, including those governing air emissions, wastewater discharge and the storage and handling of chemicals and hazardous substances. In addition, as part of our operations in the United States, we may be required to file a notice or application with the Committee on Foreign Investment in the United States (“CFIUS”) should the Food Security is National Security Act of 2021 be passed by the United States Congress.

If we fail to comply with such laws and regulations, we could be subject to significant fines, penalties, costs, liabilities or restrictions on operations, which could negatively affect our financial condition. Regulatory permits required for our operations may also be subject to periodic renewal and, in certain circumstances, modification or revocation. Environmental and occupational health and safety laws and regulations, and the interpretation and enforcement thereof, are subject to change and have tended to become stricter over time, in India and internationally. While we are not aware of any outstanding material claims or obligations, we may incur substantial costs, including clean up or remediation costs, fines and civil or criminal sanctions, and third-party property damage or personal injury claims, as a result of violations of or liabilities under environmental or health and safety laws or non-compliance with permits required at our facilities, which, as a result, may have an adverse effect on our business and financial condition. For instance, we were required to temporarily shut down operations at one of our Noida facilities for a period of approximately one month, pursuant to notices issued by the National Green Tribunal in July 2013 on account of alleged non-compliance with environmental pollution norms. Although the notices were set aside by the National Green Tribunal on September 10, 2013, we cannot assure you that a similar situation will not recur in the future.

In addition, some of our principal customers are agricultural and CFM companies, whose operations are geographically diverse and subject to or affected by a wide array of regulations in the jurisdictions where they operate, such as applicable environmental and health and safety laws and regulations. As a result of changes in regulations and laws relating to such sectors, our customers’ operations may be disrupted or curtailed. The cost of compliance with such laws and regulations may also induce certain customers to discontinue or limit certain operations or discourage them from developing new opportunities. As a result of these factors, demand for our products may be negatively affected by regulations adversely impacting the industries and geographies in which our principal customers operate.

***28. If more stringent labour laws or other industry standards in India become applicable to us, our profitability may be adversely affected.***

We are subject to a number of stringent labour laws. India has stringent labour legislation that protects the interests of workers, including legislation that sets forth detailed procedures for dispute resolution and employee removal and legislation that imposes financial obligations on employers upon retrenchment and periodic revisions to minimum wage. We are also subject to international, federal, state and local laws and regulations, in all jurisdictions where we have operations, governing our relationships with our employees, including those relating to minimum wage, overtime, working conditions, hiring and firing, non-discrimination, work permits and employee benefits. Recently, the Government of India enacted the Code on Wages, 2019, the Occupational Safety, Health and Working Conditions Code, 2020 and the Industrial Relations Code, 2020, all of which will be brought into force on a date to be notified by the Central Government. For further information, see “***Key Regulations and Policies in India***” on page 176. These codes propose to subsume several existing laws and regulations in India and we cannot assure you that these codes will not impose more stringent or additional compliance requirements on us, which may increase our compliance costs and adversely affect our profitability. Further, we may be subject to changing judicial interpretation of the relevant statutes, which may adversely affect our cash flows and profitability. For instance, the Supreme Court of India in a recent judgment has upheld the circular dated March 20, 2019 issued by the Employees’ Provident Fund Organisation, which excludes certain allowances from the definition of ‘basic wages’ of the relevant employees for the purposes of determining contribution to provident fund under the EPF Act and while we typically assess the impact of such developments on our operations and expenses, we cannot assure that we will not be adversely affected by such developments in the future.

If labour laws become more stringent or are more strictly enforced, it may become difficult for us to maintain flexible human resource policies, discharge employees or downsize, any of which could have an adverse effect on our business, results of operations, financial condition and cash flows.

In order to retain flexibility and control costs, we appoint independent contractors who in turn engage on-site contract labour for performance of certain of our operations in each of our business verticals. Although we do not engage these laborers directly, we may be held responsible for any wage payments to be made to such laborers in the event of default by such independent contractor. Any requirement to fund their wage requirements may have an adverse impact on our results of operations and financial condition. In addition, under the Contract Labour (Regulation and Abolition) Act, 1970, as amended, we may be required to absorb a number of such contract labourers as permanent employees. In the event of any non-compliance by contractors with statutory requirements, legal proceedings may be initiated against us. Thus, any such order from a regulatory body or court may have an adverse effect on our business, results of operations and financial condition. Further, any upward revision of wages that may be required by the state government to be paid to such contract labourers or the unavailability of the required number of contract labourers, may adversely affect the business and future results of our operations.

**29. *Our manufacturing facilities are dependent on adequate and uninterrupted supplies of electricity, water and fuel; shortage or disruption in electricity, water or fuel supplies may lead to disruption in operations, higher operating cost and consequent decline in operating margins.***

Adequate and cost effective supply of electrical power, water and fuel is critical to our manufacturing facilities. In Fiscal 2019, 2020 and 2021, and in the nine month ended December 31, 2021, the power, water and fuel costs was ₹ 376.73 million, ₹ 342.50 million, ₹ 333.39 million and ₹ 354.61 million, for each respective period accounted for 3.55%, 3.78%, 3.69% and 4.01% of our total revenue from operations, respectively.

There may be power cuts in the supply provided by the respective state electricity boards from time to time and so we have stand-by captive generator sets and UPS system for our operations to ensure that there is no stoppage in our production. Power costs represent a significant portion of our operating costs. If the per unit cost of electricity is increased by the state electricity boards our power costs will increase. It may not be possible to pass on any increase in our power costs to our customers, which may adversely affect our profit margins. An interruption in or limited supply of electricity may result in suspension of our manufacturing operations. Interruptions of electricity supply can also result in production shutdowns, increased costs associated with restarting production and the loss of production in progress. A prolonged suspension in production could materially and adversely affect our business, financial condition or results of operations. If supply is not available for any reason, we will need to rely on alternative sources, which may not be able to consistently meet our requirements. Further, if for any reason such electricity is not available, we may need to shut down our plants until an adequate supply of electricity is restored. The cost of such purchased power would be significantly higher, thereby adversely affecting our cost of production and profitability

Our operations and facilities are dependent on a steady and stable supply of water, and irregular or interrupted supply of water, or government intervention are factors that could adversely affect our daily operations. If there is an insufficient supply of water to satisfy our requirements or a significant increase in prices, we may need to limit or delay our production, which could adversely affect our business, financial condition and results of operations. We cannot assure you that we will always have access to sufficient supplies of water in the future to accommodate our production requirements and planned growth. In addition to the production losses that we would incur during production shutdowns in the absence of supply of electrical power or water, we would not be able to immediately return to full production volumes following power interruptions, however brief. Any interruption of power, even if short, could give rise to inefficiencies when we resume production.

**30. *Our operational flexibility may be limited in certain respects on account of our obligations under some of our customer agreements, terms of purchase and established practices.***

We conduct business with our customers on the basis of agreements, terms of purchase or established practices. Our pricing terms, payment cycles and permitted adjustments are generally set out in advance in our customer contracts or purchase orders and we also renegotiate/reset prices on a periodic basis including for adjustments beyond a specified range in the event of significant unanticipated changes in, for instance, raw material prices or currency exchange rate fluctuation. Due to committed delivery schedules at a pre-agreed price, we may not be able to adequately adjust our inventory and raw material costs in the event of an unanticipated change or cancellation in orders from our customers and we may, therefore, in certain events, incur additional costs that we are unable to pass through to our customers or be required to write off certain expenses. For instance, in the event

of any inability to deliver our products on a timely basis, we may be subject to certain penalties including the requirement to bear additional freight costs (including air freight) under the terms of our arrangements with our customers. In Fiscal 2019, 2020 and 2021, and in the nine month ended December 31, 2021, our air freight cost was ₹ 224.91 million, ₹ 33.38 million, ₹ 131.23 million and ₹ 81.07 million, respectively, and accounted for 2.32%, 0.39%, 1.58% and 1.14%, respectively, of our total expenses.

Due to the packaging, transport and labelling laws that apply to our customers in the jurisdictions in which they operate, we are also required to adhere to standards specified by our customers in relation to the delivery of our products to them and any non-conformity with such specifications may result in the rejection of an order even where there is neither any defect in our product nor any delay or deficiency in the delivery. In the event that we are unable to adhere to specified safety, quality and competitive standards and specifications on packaging transport and labelling, including in relation to on-time delivery or on-site or off-site inspections of our products and facilities or in relation to our committed reporting requirements or the requirement to obtain adequate product liability insurance, we may not be able to continue to enjoy our relationships with such major customers on the same terms over the long-term, or at all. In addition, there have been two instances of product liability claims in 2021. There was one product fault claim in the United States for an amount of USD 5,814 (₹ 0.43 million) that was settled by insurance, while there was another product fault claim in Germany which is currently under review.

Some of our customer arrangements also require us to obtain the prior approval of our customers before implementing any significant change in manufacturing method, supplier base, factory location, part specification or shipment carrier or prior to sub-contracting or assigning any of our obligations. There can be no assurance that any such consent, if sought by us, will be received within a reasonable time or at all. While general terms of business or established practices with major customers generally allow us a right of consultation as to difficulties faced by us or provide for certain decisions or adjustments to be made as per mutual agreement, our customers are generally permitted under the terms of such agreements to exercise a high level of discretion. Consequently, we are exposed to the risk that our submissions or requests as to price adjustments or delivery schedules or otherwise may not be agreed to by our customers or our customers may not accede to provide consents sought by us. Any such significant operational constraint may adversely affect our business, financial condition, results of operations and prospects.

Further, under the terms of business with some of our customers, we are required to provide an annual cost reduction in relation to our products. Although we continue to focus on value engineering and process innovation, there can be no assurance that such initiatives will enable us to maintain or improve our margins. Any significant cost reductions that we are not able to compensate for through value engineering and process innovation may, therefore, reduce our profitability.

We are also bound by confidentiality obligations under our non-disclosure agreements with our customers to protect their intellectual property, including in relation to technical data such as product designs, drawings, prototypes and any other intellectual property or proprietary data that may have been shared with us by our customers. While we believe that we have not been in breach of any such confidentiality obligations, an inadvertent breach or any misuse of intellectual property or proprietary data by any of our employees or sub-contractors may expose us to expensive infringement claims and may diminish our goodwill and reputation among our customers, suppliers, lenders, investors and the public, making it difficult for us to operate our business and compete effectively.

**31. *An inability to manage our growth may disrupt our business and reduce our profitability.***

As part of our growth strategy, we are committed to continuing to diversify our product offerings, customer base and geographic footprint and minimizing our exposure to individual market and segment declines. Our growth requires us to continuously invest in our operations, evolve and improve our operational, financial and internal controls and administrative infrastructure. In particular, this significantly increases the challenges involved in:

- maintaining high levels of customer satisfaction;
- acquiring new customers and increasing/maintaining contribution from existing customers;
- maintaining the quality and precision level of our products;
- preserving a uniform work culture and environment across our sites and maintaining and improving operational synergies between our sites, including our international locations;
- arranging for adequate financial resources (whether in the form of debt or equity or a combination thereof) for planned improvements and expansions;
- obtaining required lender consents;

- managing our relations with our labour force and successfully resolving any labour disputes that may arise from time to time; and
- recruiting, training and retaining sufficient skilled technical, marketing and management personnel.

In addition, we may not be successful in implementing our strategy of focussing on value-added products and enhanced service offerings in order to improve our margin profile of our revenue portfolio. An inability to manage our growth, including as a result of a failure to adequately respond to any such challenges, risks or uncertainties, may disrupt our business and reduce our profitability.

**32. *The discontinuation or loss of business, with respect to a particular OHV model for which we are a significant supplier could reduce our sales and profitability.***

Purchase orders from our customers generally provide for the supply of a customer's periodic requirements for components for a particular OHV model, rather than for the supply of a customer's requirements for components for the life of a particular OHV model or for the purchase of a specific quantity of components. Therefore, in the event that a particular OHV model is discontinued by our customer or demand for a particular OHV model is significantly less than anticipated by the relevant customer, it may adversely affect our inventory management and, in turn, our sales and profitability could be adversely affected. In addition, it is possible that our customers could elect to internally manufacture components that are currently produced by outside suppliers, such as us, or source the products from an alternate supplier. For instance, there have been instances where we have had to incur write-offs on account of obsolete and slow moving inventory. In Fiscal 2021, our Subsidiary, UOI, wrote-off inventory which were accumulated over a period worth USD 1,440,840 (₹ 106.95 million) on account of obsolete and slow-moving inventory for discontinued projects. The reduction in demand for, and sales of, our products for any such reason may have a consequent adverse impact on our business, financial condition, results of operations and prospects, particularly to the extent that we are unable to sell or appropriately dispose of the inventory that we maintain or are required to continue maintaining for any OHV models that are discontinued by our customers (for which we are not fully compensated by them) or for which there is no longer any significant demand in the markets in which our customers operate.

**33. *Under-utilization of our manufacturing capacities and an inability to effectively utilize our expanded manufacturing capacities could have an adverse effect on our business, future prospects and future financial performance.***

The success of any capacity expansion and expected return on investment on capital expenditure is subject to, among other factors, the ability to procure requisite regulatory approvals in a timely manner; recruit and ensure satisfactory performance of personnel to further grow our business; and the ability to absorb additional infrastructure costs and develop new expertise. Our capacity utilization is also affected by the product requirements of, and procurement practice followed by, our customers. In recent times, we have made investments for the expansion of our manufacturing capacities and are continuing to undertake additional investments to increase our existing capacity. Our expected return on capital invested is subject to, among other factors, the ability to ensure satisfactory performance of personnel to further grow our business, our ability to absorb additional infrastructure costs and utilize the expanded capacities as anticipated. In case of oversupply in the industry or lack of demand we may not be able to utilise our expanded capacity efficiently. In Fiscal 2019, 2020 and 2021, and in the nine months ended December 31, 2021, our capacity utilization at (i) Ludhiana, Punjab (I) was 94.58%, 69.44%, 81.03%, and 102.71%, respectively; (ii) Ludhiana, Punjab (II) was 70.20%, 67.81%, 71.13%, and 81.92%, respectively; (iii) Visakhapatnam, Andhra Pradesh was 78.08%, 62.35%, 58.86%, and 82.48%, respectively; (iv) Noida, Uttar Pradesh (I) was 80.12%, 54.21%, 63.68%, and 87.59%, respectively; (v) Noida, Uttar Pradesh (II) was 91.28%, 70.13%, 70.07%, and 84.14%, respectively, and (vi) UOI, United States was 71.82%, 54.99%, 47.00% and 49.28%, in the same periods. For further information, see "***Our Business - Installed Capacity and Capacity Utilization***" on page 167. Under-utilization of our manufacturing capacities over extended periods, or significant under-utilization in the short term, or an inability to fully realize the benefits of our recently implemented capacity expansion, could materially and adversely impact our business, growth prospects and future financial performance.

**34. *Information relating to our production capacities and the historical capacity utilization of our manufacturing facilities included in this Draft Red Herring Prospectus is based on various assumptions and estimates and future production and capacity utilization may vary.***

Information relating to our production capacities and the historical capacity utilization of our manufacturing facilities included in this Draft Red Herring Prospectus is based on various assumptions and estimates of our

management that have been taken into account by the chartered engineer in the calculation of our capacity. These assumptions and estimates include the standard capacity calculation practice of manufacturing industry after examining the calculations and explanations provided by our Company and the capacities and other ancillary equipment installed at the manufacturing facilities, the period during which the manufacturing facilities operate in a year, availability of raw ingredients, expected utilization levels, downtime resulting from scheduled maintenance activities, unscheduled breakdowns, as well as expected operational efficiencies. Actual production levels and utilization rates may differ significantly from the estimated production capacities or historical estimated capacity utilization information of our facilities. Undue reliance should therefore not be placed on our production capacity or historical estimated capacity utilization information for our existing facilities included in this Draft Red Herring Prospectus. For further information, see “*Our Business – Installed Capacity and Capacity Utilization*” on page 167.

35. ***We face competition in all our product lines, including from competitors that may have greater financial and marketing resources. Failure to compete effectively may have an adverse impact on our business, financial condition, results of operations and prospects.***

Our domestic and international operations are subject to competitive pressures in all our product lines. We compete directly and indirectly with other manufacturers and suppliers of engineered components to OEMs (including OEMs that produce such components for their own use) and in the aftermarket. We compete on the performance, functionality, customer service and support, availability, price and brand recognition of our products. Increased competition may force us to improve our process, technical, product and service capabilities and / or lower our prices or result in loss of customers, which may adversely affect our profitability and market share, in turn, affecting our business, financial condition, results of operations and prospects.

The greater financial, marketing, technological and other resources of certain of our competitors may enable them to commit larger amounts of capital in response to changing market conditions, or to achieve substantially more market penetration in certain segments of those markets in which we operate or to anticipate the course of market developments and trends more effectively than we do and to develop product and process innovations and capabilities that may put us at a disadvantage. We may also face competition from new entrants in the market as well as aggressive pricing and marketing strategies by other manufacturers trying to gain market share. Further, competitors in other countries may be more competitive in terms of pricing due to lower labour and other costs. Moreover, some of the other component manufacturers that we compete with may have the benefit of greater consolidation and integration (for instance, including captive consumption of components produced by them) or greater diversification (in terms of other businesses that are not exposed to the economic and financial pressures that affect the OHV components manufacturing business or the agriculture and CFM segments) or lower costs in relation to manufacturing structures and lower costs of transportation in our key markets.

There are several competing producers of varying size and in various geographical markets. Therefore, as the parameters of competition in this business are less firmly established than in certain other types of businesses, we believe that it is difficult to predict how the competitive landscape of our business will develop over the long term. General competitive factors in the market, which may affect the level of competition over the short and medium term, include vulnerability to overall macroeconomic factors, time to market, product features, design, quality, price, delivery, warranty, general customer experience and relationships between producers and their customers.

36. ***If we fail to maintain an effective system of internal controls, we may not be able to successfully manage, or accurately report, our financial risks.***

Effective internal controls are necessary for us to prepare reliable financial reports and effectively avoid fraud. Any internal controls that we have or may implement, or our level of compliance with such controls, may deteriorate over time due to evolving business conditions. There can be no assurance that deficiencies in our internal controls will not arise in the future, or that we will be able to implement, and continue to maintain, adequate measures to rectify or mitigate any such deficiencies in our internal controls. Any inability on our part to adequately detect, rectify or mitigate any such deficiencies in our internal controls may adversely impact our ability to accurately report, or successfully manage, our financial risks, and to avoid fraud.

37. ***Our insurance coverage may not adequately protect us from all material risks and liabilities.***

Our business, including our manufacturing operations in particular, carry an inherent risk of exposure to substantial liability for product liability, property damage, personal injury or death, environmental pollution or other damage. We maintain insurance coverage in respect of our buildings, plant and machineries, fixtures and

fittings, other equipment and inventories, covering losses due to fire (including standard fire and allied perils) and burglary, as well as fidelity guarantee and money insurance policies. As of December 31, 2021, we have 100% or more insurance coverage of book value of our fixed assets and inventories.

In addition, we cover our employees under group accident and medical insurance programs, except in respect of locations where our workforce is covered under the ESI scheme. We have also obtained a group term life policy for our employees in India. However, our insurance is subject to customary deductibles, exclusions and limits which may prevent us from fully recovering our losses, or our insurance may not be adequate to cover our liabilities. There may also be certain types of risks for which we are not covered. Further, there is no assurance that insurance will be generally available in the future or, if available, that the premiums will be commercially justifiable. If we incur substantial liability which is not covered by insurance or exceed policy limits, our business, financial condition, results of operations and prospects may be adversely affected. We cannot assure you that any claim under the insurance policies maintained by us will be honoured full or on time, or that we have taken out sufficient insurance cover to all our losses.

**38. *Our strategy to enhance engineering, innovation and design competence may not yield the expected benefits.***

We focus on process and product innovation and value engineering solutions in order to meet the requirements of a wider range of OHVs, geographies, applications and other customer specifications, so as to strengthen and diversify our product portfolio and enhance our profit margins. Towards this objective, we continue to develop our in-house value engineering and process innovation capabilities through human resource and technical development, as well as exploring opportunities for collaboration and inorganic growth as well as by continuing to work closely with our customers to upgrade and customize our products. For further information, see “*Our Business – Strategies – Enhance engineering, innovation and design competence*” on page 158.

In our experience, the agriculture and CFM sectors have been tending towards increased mechanization, especially in recent years. Our customers, especially global OEMs, are increasingly developing larger, more technically complex products, projects, processes and applications. To meet our customers’ requirements, we must regularly update existing technology or know-how or acquire or develop new technology or know-how. In addition, shifts in customer demand can render existing technologies and machinery obsolete, requiring additional capital expenditures and/or write-downs of assets. Our failure to anticipate and adequately respond to evolving technical and technological specifications and market trends may adversely affect our business, financial condition, results of operations and prospects.

Planned product upgrades may be subject to unanticipated delays or our competitors’ products may be more effective or innovative and/or less expensive or may garner larger market share due to other reasons beyond our present knowledge or control, thus yielding lower sales and profits relative to our expectations.

**39. *Our Company, Subsidiaries and certain of our Directors and Promoters are involved in certain legal proceedings, which, if determined adversely, may adversely affect our business and financial condition and our contingent liabilities which have not been provided for may adversely affect our financial condition.***

Our Company, Subsidiaries and certain of our Directors and Promoters are involved in certain legal proceedings (including central excise and sales tax and commercial disputes) at different levels of adjudication before various courts, tribunals and appellate authorities. In the event of adverse rulings in these proceedings or consequent levy of penalties by other statutory authorities, our Company, Subsidiaries, Directors or Promoters may need to make payments or make provisions for future payments, which may increase expenses and current or contingent liabilities and also adversely affect our reputation.

A summary of the proceedings involving our Company, Subsidiaries, Directors and Promoters is provided below:

<b>Particulars</b>	<b>Criminal Proceedings</b>	<b>Tax Proceedings</b>	<b>Actions by statutory or regulatory authorities</b>	<b>Disciplinary actions including penalty imposed by SEBI or stock exchanges against our Promoters</b>	<b>Material civil litigation</b>	<b>Aggregate amount involved* (₹ in million)</b>
<b>Company</b>						
By our Company	2	-	-	-	1	67.91

Particulars	Criminal Proceedings	Tax Proceedings	Actions by statutory or regulatory authorities	Disciplinary actions including penalty imposed by SEBI or stock exchanges against our Promoters	Material civil litigation	Aggregate amount involved* (₹ in million)
Against our Company	-	28	1	-	-	102.23
<b>Directors</b>						
By our Directors	-	-	-	-	-	-
Against our Directors	-	5	-	-	-	1.82
<b>Promoters</b>						
By our Promoters	-	-	-	-	-	-
Against our Promoters	-	3	-	-	-	1.82
<b>Subsidiaries</b>						
By our Subsidiary	-	-	-	-	-	-
Against our Subsidiary	-	2	-	-	-	0.20

\*Amount to the extent quantifiable.

For further information, see “*Outstanding Litigation and Other Material Developments*” on page 389.

In addition, as of December 31, 2021, our capital and other commitments (contingent liabilities) not provided for in our Restated Financial Statements are as follows:

Particulars	Amount (₹ million)
<b>Claims against the company not acknowledged as debt</b>	
- Sales Tax Matters	2.51
- Excise Matters	0.21
- GST Matters	0.36
<b>Income Tax Matters</b>	59.74
<b>Sales Tax Liability against pending forms</b>	-
<b>Others</b>	
- Guarantees given on behalf of the company by banks	
(i) Sales Tax Matters	0.03
(ii) Pollution Control Board	0.05
(iii) Gas Connections	2.68
<b>Total</b>	<b>65.58</b>

Our ascertainable contingent liabilities constitute 0.98% of our net worth as on December 31, 2021. No provisions have been made for possible liabilities arising out of any outstanding litigations. If these contingent liabilities materialize, fully or partly, our financial condition may be adversely affected. For further information, see “*Restated Financial Statements – Annexure V – Note 30*” and “*Outstanding Litigation and Other Material Developments*” on pages 289 and 389, respectively.

**40. Certain of our immovable properties in India and overseas, and machinery are leased by us. If we are unable to renew existing leases or relocate our operations on commercially reasonable terms, there may be an adverse effect on our business, financial condition and operations.**

Certain of our manufacturing and warehousing facilities in India and overseas are held by us on leasehold basis, from third parties, related parties and certain Government authorities on certain terms and conditions. Further, the leases for these premises require periodic renewal and are subject to periodic escalation of lease payments. Some of our leased premises in Noida, Uttar Pradesh, Ludhiana, Punjab and in the United States have lessor lock-in periods ranging from two to five years which is shorter than the time period for which we expect to utilize these premises and therefore in the event of any such termination we may be required to either re-negotiate terms or shift our operations to alternate locations on expiry. As of March 31, 2019, 2020 and 2021, and as of the nine months ended December 31, 2021, our total lease rentals paid under leases relating to land, building premises, machinery and others amounted to ₹ 143.42 million, ₹ 156.20 million, ₹ 133.73 million and ₹ 92.09 million, respectively.

If we are unable to renew certain or all of these leases on commercially reasonable terms, we may suffer a disruption in our operations or be unable to continue to operate from those locations in the future (and may, to that extent, need to revise our raw material sourcing, product manufacturing and raw material and product inventory schedules and/or incur significant costs to relocate or expand our operations elsewhere in order to continue to honour our commitments to our customers). In addition, the terms of certain of our leases require us (as the lessee) to incur certain repair and maintenance costs from time to time and to bear utility charges, and include conditions which may restrict our operational flexibility in certain respects, for instance, requiring us to obtain the lessor's prior consent for certain actions (including making significant structural alterations to the factory building, which may be required if we were to undertake a significant expansion in the future, or for undertaking a corporate restructuring or to sublet, transfer, assign, charge or mortgage such properties). For further information on our immovable properties, see "**Our Business – Properties**" on page 173.

**41. *Some of the loans availed by us and our Subsidiaries may be recalled by the lenders at any time, which may lead to default in terms of such financing agreements.***

As on December 31, 2021, our loans from banks, which are repayable on demand, amounted to ₹ 1,335.33 million and are liable to be recalled by the respective lenders at any time. Any failure to service such indebtedness, comply with a requirement to obtain lender consent or otherwise perform such obligations under such financing agreements may lead to a termination of one or more of our credit facilities or penalties and acceleration of amounts due under such credit facilities, which may adversely affect our business, financial condition, results of operations and prospects.

**42. *Three of our manufacturing facilities are operated on industrial land allotted to us by industrial development corporations. Failure to comply with the conditions of use of such land could result in an adverse impact on our business and financial condition.***

We have five manufacturing facilities in India, of which three of our facilities (both of our facilities in Ludhiana and one of our facilities in Noida) are operated on industrial land allotted to us by state owned industrial development corporations, specifically the Punjab Small Industries & Export Corporation Limited in Punjab and the New Okhla Industrial Development Authority in Noida (together the "IDCs"). Under the terms of the lease by which land was allotted to us, we are required to comply with certain ongoing conditions, including achieving the investment commitment set out in the project report, adhering to the timelines for completion of setting up of the manufacturing facility, and commencement of manufacturing activity. If we fail to meet any such conditions, we may be required to incur additional liability. Further, according to the various statutory rules under which each of the IDCs function, they also retain the power to cancel allotment of land in the event of breach of any rules of allotment. Cancellation of the land allotted by way of lease to us could have an impact on our financial condition which could adversely impact our results of operations and financial condition.

**43. *There are several restrictions on SEZs and underlying SEZ land in India, which may adversely affect our Visakhapatnam facility and one of our Noida facilities.***

One of our Noida facilities and our Visakhapatnam facility are situated in special economic zones ("SEZs") and our leases for these premises, therefore, restrict our ability to use these locations to manufacture products for domestic sales (i.e., other than for exports) or to undertake any new line of business. Under the prevailing law governing SEZs in India, the land area in an SEZ may be demarcated into a processing area for setting up units for manufacture of products or provision of services, or an area exclusively for trading or warehousing purposes, or a non-processing area for other activities. The lease period for space in the processing area or the free trade and warehousing zone within an SEZ has to be for a minimum period of five years. Moreover, the developer cannot remove goods from the SEZ to the domestic tariff area ("DTA") without permission from the relevant authority and, where applicable, certain duties are to be paid for clearance of goods in DTA. There are also certain restrictions on transfer of SEZ units, including the requirement to obtain the approval of the relevant authority for any proposed sale or transfer of an SEZ unit and a lock-in period in terms of the SEZ land having been leased for a minimum period of five years and a minimum operating history of at least two years from commencement of operations of the SEZ unit proposed to be sold or transferred.

Further, the approvals received by us to develop, operate and maintain the SEZs are subject to us fulfilling certain conditions, including compliance with environmental safety standards, applicable standards relating to planning, sewage disposal, pollution control, labour laws and execution of certain guarantees. In the event we are unable to comply with the restrictions under the laws governing SEZs in India, our rights to use our units demarcated as



SEZs may be suspended or withdrawn and the guarantees provided by us may be invoked against us as a penalty, which may in turn adversely affect our business, financial condition, results of operations and prospects.

In the event that regulatory authorities allege non-compliance of the Special Economic Zones Rules, 2006 and subject us to regulatory action for any reason in the future, we may be subject to consequences including penalties or seizure of land. Any such action or any changes to the SEZ regime may adversely affect our business, financial condition, results of operations and prospects.

**44. *We are entitled to certain tax benefits under the Special Economic Zones Act, 2005 (“SEZ Act”) and other fiscal statutes. These tax benefits are available for a definite period of time, which, on expiry or if withdrawn prematurely, may adversely affect our business, financial condition, results of operations and prospects.***

We are entitled to claim certain direct tax exemptions or reimbursements on account of parts of our manufacturing facility in Noida and the whole of our manufacturing facility in Visakhapatnam being situated in SEZs. For instance, we are entitled to exemptions from (or refunds on account of) the following duties and levies:

- taxes and duty on import/domestic procurement of goods for development, operation and maintenance of SEZ operations;
- payment of GST for goods brought from a DTA into the SEZ for its authorized operations;
- payment of central sales tax, value added tax, excise duty and service tax, which is applicable in case of petroleum products; and
- payment of income tax for a period of 15 years from commencement of production at the SEZ, as follows:
  - 100% deduction of income from profits and gains from exports for the first five years;
  - 50% deduction of income from profits and gains from exports for the next five years;
  - 50% deduction of income from profits and gains from exports, which have been credited to the reserve account to be utilized for the purpose of the said business for the next five years.

For further information, see “*Statement of Possible Special Tax Benefits*” on page 108.

Our profitability will be affected to the extent that such benefits are not available beyond the periods currently contemplated. Our profitability may be further affected in the future if any benefit under the statute is reduced or withdrawn prematurely or if we are subject to any dispute with the tax authorities in relation to these benefits. Further, under the SEZ Act, we are required to maintain positive net foreign exchange earning that is to be calculated cumulatively for a period of five years from the commencement of our operations carried out from the SEZs. If we fail to maintain positive net foreign exchange earnings, we would be subject to penalties as prescribed under the Foreign Trade (Development and Regulation) Act, 1992, including penalties of up to five times the value of the goods in respect of which contravention is made. In the event that any adverse development in the law or the manner of its implementation affect our ability to benefit from these tax incentives, our business, financial condition, results of operations and prospects may be adversely affected.

**45. *Our Company may not be able to pay dividends in the future. Our ability to pay dividends in the future will depend on our earnings, financial condition, working capital requirements, capital expenditures and re-strictive covenants of our financing arrangements.***

Any dividends to be declared and paid in the future are required to be recommended by our Company’s Board of Directors and approved by our Shareholders, at their discretion, subject to the provisions of the Articles of Association and applicable law, including the Companies Act, 2013, as amended. Our Company’s ability to pay dividends in the future will depend upon our future results of operations, financial condition, cash flows, sufficient profitability, working capital requirements and capital expenditure requirements. Pursuant to the dividend policy, while the Board is required to endeavour to maintain an annual dividend pay-out of 25% of consolidated profit as dividend, it has the discretion to deviate from the pay-out percentage in consideration of all relevant factors as laid down in the dividend policy. We cannot assure you that we will generate sufficient revenues to cover our operating expenses and, as such, pay dividends to our Company’s shareholders in future consistent with our past practices, or at all. We may retain all future earnings, if any, for use in operations and expansion of business. Additionally, our ability to pay dividends may also be restricted by the terms of financing arrangements that we may enter into. Dividends distributed by us will attract dividend distribution tax at rates applicable from time to time. For further information in relation to dividend declared by our Company in the past, see “*Dividend Policy*” on page 211 of this Draft Red Herring Prospectus.

**46. *Grants of stock options under our employee stock option plan may result in a charge to our profit and loss account and, to that extent, reduce our profitability and financial condition.***

As on the date of this Draft Red Herring Prospectus, 1,039,200 stock options have been granted to eligible employees and are outstanding under ESOP 2007, of which 123,198 options have vested and been exercised. For further information, see “*Capital Structure – Employee Stock Option Schemes of our Company*” on page 99.

Under Ind AS, the grant of employee stock options results in a charge to our Company’s profit and loss account equal to the intrinsic value (which will amortize over the vesting period of these stock options) based on the difference between the fair value of our Equity Shares determined at the date of grant and the exercise price. Our expenses related to ESOP 2007 amounted to ₹ 1.99 million, ₹ 5.85 million, ₹ 4.03 million and ₹ 7.85 million in Fiscal 2019, 2020 and 2021 and in the nine months ended December 31, 2021, and accounted for 0.02%, 0.07%, 0.05% and 0.11%, respectively, of our total expenses.

**47. *We will not receive any proceeds from the Offer for Sale.***

The Offer comprises an Offer for Sale by the Selling Shareholders. Our Selling Shareholders will receive the entire proceeds from the Offer for Sale (after deducting applicable Offer expenses) and our Company will not receive any part of the proceeds of the Offer. For further information, see “*The Offer*” and “*Objects of the Offer*” on pages 76 and 103, respectively.

**48. *We may not be able to adequately protect our intellectual property rights, including the use of the “Uniparts” name and associated logo, which could harm our competitiveness.***

We believe that the use of our name and logo is vital to our competitiveness and success and for us to attract and retain our clients and business partners. Any improper use or infringement by any party could adversely affect our business, financial condition and results of operations. We cannot assure you that the measures we have taken will be sufficient to prevent any misappropriation of our intellectual property.

Enforcement of any intellectual property rights could be time consuming and costly. We may not be able to establish our rights to such intellectual property in the absence of relevant registrations and accordingly may not be able to take appropriate action or prevent the use of such name or logo by third parties. In the event that the measures we take do not adequately safeguard our intellectual property rights, we could suffer losses due to competing offerings of services that exploit our name and logo. For instance, we recently sought registration of the wordmark “GRIPWEL” in the United States however our application was rejected.

All our trademarks are registered in the name of our Company under class 12, except for the wordmark “GRIPWEL” which is registered under the name of one our Subsidiary, GFPL, under classes 6, 7 and 12 in Canada and classes 7 and 12 in the European Union. Any improper use by our Subsidiaries could adversely affect our business, financial condition and results of operations. We may also be subject to claims for breach of intellectual property by third parties in the event we are unable to secure adequate protection in relation to our name and logo. UIG, our Subsidiary in Germany, received a letter dated June 18, 2015 from a representative of Unipart Group Limited (“UGL”), which is a third party, requiring us to cease using the mark “UNIPART” in Europe claiming that they hold registrations for the term “Unipart” under various classes in Europe as Community Trade Marks. While we have sought to resolve the dispute amicably, and expect to hold discussions on the terms of co-existence in due course, we cannot assure you we will be successful in reaching an amicable settlement or that UGL will not initiate legal proceedings against us in the future.

**49. *Discontinuance or non-availability of fiscal benefits enjoyed by us or our inability to comply with related requirements may have an adverse effect on our business and results of operations.***

Our Company currently enjoys certain fiscal benefits on account of policies of the GoI, including concessions under the Export Promotion Capital Goods Scheme (the “EPCG Scheme”) of the GoI. The EPCG scheme allows import at zero custom duty and requires the importer to export equivalent to six times of duty saved on capital goods. Such equivalent amount is required to be fulfilled within six years from the date of issue of authorization. A 50% export obligation is required to be fulfilled within the first four years with the remaining 50% within the next two years. Non-fulfilment of such obligations may result in confiscation of capital goods imported under this scheme and other penalties as set out in this scheme. In the event of any default under the EPCG Scheme, our results of operations may be adversely affected. As we seek to export a larger proportion of our systems and

components outside India, any changes in the policies of the GoI could have a material adverse effect on our results of operations and financial condition.

Prior to January 1, 2021, we were also eligible to avail the incentives under the Merchandise Exports from India Scheme (“MEIS”), pursuant to which, we could use duty credit scrips for payment of import duty obligations or sell such duty credit scrips in the open market to other importers. However, the Ministry of Finance, GoI has discontinued MEIS with effect from January 1, 2021 and announced a scheme for remission of duties and taxes on export products (“RODTEP Scheme”) for exporters. The scheme, like MEIS scheme, allows the exporter for the payment of import duty or sell such duty credit scrips in the open market to other importers. The rates of the schemes vary. Any further change in the rates and / or the scheme structure announced by GoI can have material adverse effect on our results of operation or financial condition.

**50. *Our Promoters and Promoter Group will retain majority shareholding in our Company following the Offer, which will allow them to exercise significant influence over us and may cause us to take actions that are not in our or your best interest.***

After the completion of this Offer, our Promoters and Promoter Group will collectively hold 63.02% of our Company’s issued and outstanding Equity Shares. So long as our Promoters and Promoter Group own a significant portion of our Equity Shares, they will be able to significantly influence the election of our Directors and control most matters affecting our Company, including our business strategies and policies, decisions with respect to mergers, business combinations, acquisitions or dispositions of assets, dividend policies, capital structure and financing, and may also delay or prevent a change of management or control, even if such a transaction may be beneficial to other shareholders of our Company. The interests of our Promoters and Promoter Group, as the controlling shareholders of our Company, may also conflict with our Company’s interests or the interests of our Company’s other shareholders. As a result, our Promoters and Promoter Group may take actions that conflict with our Company’s interests or the interests of other shareholders of our Company.

#### **External Risk Factors**

**51. *Recent global economic conditions have been challenging and continue to affect the Indian market, which may adversely affect our business, financial condition, results of operations and prospects.***

The Indian economy and its securities markets are influenced by economic developments and volatility in securities markets in other countries. Investors’ reactions to developments in one country may have adverse effects on the market price of securities of companies located in other countries, including India. Negative economic developments, such as rising fiscal or trade deficits, or a default on national debt, in other emerging market countries may also affect investor confidence and cause increased volatility in Indian securities markets and indirectly affect the Indian economy in general. Any worldwide financial instability could also have a negative impact on the Indian economy, including the movement of exchange rates and interest rates in India and could then adversely affect our business, financial performance and the price of our Equity Shares. Further, the generalized system of preferences, a US trade preference program, situation in the United States is also subject to changes and modification without notice and which could impact the duty structure applicable to certain of our products exported to the United States. We cannot assure that our products will not be subject adverse duty levy in any of our export markets.

Any other global economic developments or the perception that any of them could occur may continue to have an adverse effect on global economic conditions and the stability of global financial markets, and may significantly reduce global market liquidity and restrict the ability of key market participants to operate in certain financial markets. Any of these factors could depress economic activity and restrict our access to capital, which could have an adverse effect on our business, financial condition and results of operations and reduce the price of our equity shares. Any financial disruption could have an adverse effect on our business, future financial performance, shareholders’ equity and the price of our Equity Shares.

**52. *Natural or man-made disasters, fires, epidemics, pandemics, acts of war, terrorist attacks, civil unrest and other events could materially and adversely affect our business.***

Natural disasters (such as typhoons, flooding and earthquakes), epidemics, pandemics such as COVID-19 and man-made disasters, including acts of war, terrorist attacks and other events, many of which are beyond our control, may lead to economic instability, including in India or globally, which may in turn materially and adversely affect our business, financial condition and results of operations. Our operations may be adversely

affected by fires, natural disasters and/or severe weather, which can result in damage to our property or inventory and generally reduce our productivity and may require us to evacuate personnel and suspend operations. Any terrorist attacks or civil unrest as well as other adverse social, economic and political events in India or countries to whom we sell our products could have a negative effect on us. Such incidents could also create a greater perception that investment in Indian companies involves a higher degree of risk and could have an adverse effect on our business and the price of the Equity Shares.

A number of countries in Asia, including India, as well as countries in other parts of the world, are susceptible to contagious diseases and, for example, have had confirmed cases of diseases such as the highly pathogenic H7N9, H5N1 and H1N1 strains of influenza in birds and swine and more recently, the COVID-19 virus. A worsening of the current outbreak of COVID-19 pandemic or future outbreaks of COVID-19 virus or a similar contagious disease could adversely affect the global economy and economic activity in the region. For further information, see “ - *The current and continuing impact of the COVID-19 pandemic on our business and operations, including its impact on the demand for equipment in which components and parts manufactured and supplied by us are used, may have an adverse effect on our business, results of operations, financial condition and cash flows*” on page 34. As a result, any present or future outbreak of a contagious disease could have a material adverse effect on our business and the trading price of the Equity Shares.

**53. *Any downgrading of India’s sovereign debt rating by an international rating agency could have a negative impact on our business and results of operations.***

Our borrowing costs and our access to the debt capital markets depend significantly on the credit ratings of India. Any adverse revisions to credit ratings for India and other jurisdictions we operate in by international rating agencies may adversely impact our ability to raise additional financing. This could have an adverse effect on our ability to fund our growth on favourable terms and consequently adversely affect our business and financial performance and the price of the Equity Shares.

**54. *If there is any change in laws or regulations, including taxation laws, or their interpretation, such changes may significantly affect our financial statements.***

The regulatory environment in which we operate is evolving and is subject to change. The GoI may implement new laws or other regulations that could affect the component industry, which could lead to new compliance requirements, including requiring us to obtain approvals and licenses from the GoI and other regulatory bodies, or impose onerous requirements. New compliance requirements could increase our costs or otherwise adversely affect our business, financial condition and results of operations. Further, the manner in which new requirements will be enforced or interpreted can lead to uncertainty in our operations and could adversely affect our operations. Accordingly, any adverse regulatory change in this regard could lead to fluctuation of price points of various input costs and thereby increase our operational cost.

The Taxation Laws (Amendment) Act, 2019, also prescribes certain changes to the income tax rate applicable to companies in India. According to this Act, companies can henceforth voluntarily opt in favour of a concessional tax regime (subject to no other special benefits/exemptions being claimed), which would ultimately reduce the effective tax rate (on gross basis) for Indian companies from 34.94% to approximately 25.17%. Any such future amendments may affect our ability to claim exemptions that we have historically benefited from, and such exemptions may no longer be available to us. Any adverse order passed by the appellate authorities/tribunals/ courts would have an effect on our profitability. Due to COVID -19 pandemic, the Government of India had also passed the Taxation and Other Laws (Relaxation of Certain Provisions) Act, 2020, implementing relaxations from certain requirements under, amongst others, the Central Goods and Service Tax Act, 2017 and Customs Tariff Act, 1975. Further, the Government of India announced the Union Budget for Fiscal 2022 (“**Budget 2022**”), pursuant to which the Finance Bill 2022 has proposed various amendments which will only come into effect upon receipt of Presidential assent to the bill. We have not fully determined the impact of these recent and proposed laws and regulations on our business. We cannot predict whether any amendments made pursuant to the Finance Bill would have an adverse effect on our business, financial condition and results of operations.

Further, as GST is implemented, there can be no assurance that we will not be required to comply with additional procedures or obtain additional approvals and licenses from the government and other regulatory bodies or that they will not impose onerous requirements and conditions on our operations. With the implementation of GST, we are obligated to pass on any benefits accruing to us as result of the transition to GST to the consumer thereby limiting our benefits. In order for us to utilise input credit under GST, the entire value chain has to be GST

compliant, including us. While we are and will continue to adhere to the GST rules and regulations, there can be no assurance that our suppliers and dealers will do so. Any such failure may result in increased cost on account of non-compliance with the GST and may adversely affect our business and results of operations.

Further, the Government of India has announced the union budget for the Financial Year 2023, and the Finance Bill, 2022 (“**Finance Bill**”) has been introduced in Lok Sabha on February 1, 2022. The Finance Bill is scheduled to be passed in the ongoing budget session of the Parliament. We have not fully determined the impact of these recent and proposed laws and regulations on our business. We cannot predict whether any amendments made pursuant to the Finance Bill would have an adverse effect on our business, financial condition and results of operations. Unfavourable changes in or interpretations of existing, or the promulgation of new, laws, rules and regulations including foreign investment and stamp duty laws governing our business and operations could result in us being deemed to be in contravention of such laws and may require us to apply for additional approvals.

Similarly, changes in other laws may require additional compliances and/or result in us incurring additional expenditure. For instance, the Government of India has notified four labour codes which are yet to come into force as on the date of this Draft Red Herring Prospectus, namely, (i) the Code on Wages, 2019, (ii) the Industrial Relations Code, 2020; (iii) the Code on Social Security, 2020; and (iv) the Occupational Safety, Health and Working Conditions Code, 2020. Such codes will replace the existing legal framework governing rights of workers and labour relations. While the rules for implementation under these codes have not been notified, we are yet to determine the impact of all or some such laws on our business and operations which may restrict our ability to grow our business in the future. Once these codes are in force, we may be required to incur additional expenditure to ensure compliance with them. We may incur increased costs and other burdens relating to compliance with such new requirements, which may also require significant management time and other resources, and any failure to comply may adversely affect our business, results of operations and prospects. Uncertainty in the applicability, interpretation or implementation of any amendment to, or change in, governing law, regulation or policy, including by reason of an absence, or a limited body, of administrative or judicial precedent may be time consuming as well as costly for us to resolve and may impact the viability of our current businesses or restrict our ability to grow our businesses in the future.

#### **55. *Financial instability in other countries may cause increased volatility in Indian financial markets.***

The Indian market and the Indian economy are influenced by economic and market conditions in other countries, including conditions in the United States, Europe and certain emerging economies in Asia. Financial turmoil in Asia, United States, United Kingdom, Russia and elsewhere in the world in recent years has adversely affected the Indian economy. Any worldwide financial instability may cause increased volatility in the Indian financial markets and, directly or indirectly, adversely affect the Indian economy and financial sector and us. Although economic conditions vary across markets, loss of investor confidence in one emerging economy may cause increased volatility across other economies, including India. Financial instability in other parts of the world could have a global influence and thereby negatively affect the Indian economy. Financial disruptions could materially and adversely affect our business, prospects, financial condition, results of operations and cash flows. Further, economic developments globally can have a significant impact on our principal markets. Concerns related to a trade war between large economies may lead to increased risk aversion and volatility in global capital markets and consequently have an impact on the Indian economy. Following the United Kingdom’s exit from the European Union (“**Brexit**”), there still remains uncertainty around the impact of Brexit on the general economic conditions in the United Kingdom and the European Union and any consequential impact on global financial markets.

In addition, China is one of India’s major trading partners and there are rising concerns of a possible slowdown in the Chinese economy as well as a strained relationship with India, which could have an adverse impact on the trade relations between the two countries. Risks resulting from a relapse in the Eurozone crisis or any future debt crisis in Europe or any similar crisis could have a detrimental impact on consumer confidence levels and global economic recovery. In response to such developments, legislators and financial regulators in the United States and other jurisdictions, including India, implemented a number of policy measures designed to add stability to the financial markets. However, the overall long-term effect of these and other legislative and regulatory efforts on the global financial markets is uncertain, and they may not have the intended stabilizing effects. Any significant financial disruption could have a material adverse effect on our business, financial condition and results of operation. These developments, or the perception that any of them could occur, have had and may continue to have a material adverse effect on global economic conditions and the stability of global financial markets, and may significantly reduce global market liquidity, restrict the ability of key market participants to operate in certain financial markets or restrict our access to capital. This could have a material adverse effect on our business, financial condition and results of operations and reduce the price of the Equity Shares.

**56. *If inflation were to rise significantly in the geographies we operate, and in particular in India, we might not be able to increase the prices of our services at a proportional rate thereby reducing our margins.***

Inflation rates in India and other geographies where we conduct operations have been volatile in recent years, and such volatility may continue in the future. In particular, India has experienced high inflation in the recent past. Increased inflation can contribute to an increase in interest rates and increased costs to our business, including increased costs of transportation, wages, raw materials and other expenses relevant to our business. High fluctuations in inflation rates may make it more difficult for us to accurately estimate or control our costs. Any increase in inflation in India can increase our expenses, which we may not be able to adequately pass on to our customers, whether entirely or in part, and may adversely affect our business and financial condition. In particular, we might not be able to reduce our costs or entirely offset any increases in costs with increases in prices for our products. In such case, our business, results of operations, cash flows and financial condition may be adversely affected. Further, the Government has previously initiated economic measures to combat high inflation rates, and it is unclear whether these measures will remain in effect. There can be no assurance that Indian inflation levels will not worsen in the future.

***Risks Relating to the Equity Shares and this Offer***

**57. *Investors may not be able to enforce a judgment of a foreign court against us, our Directors, the Book Running Lead Managers or any of their directors and executive officers in India respectively, except by way of a law suit in India.***

Our Company is a company incorporated under the laws of India and certain of our Directors are located in India. A substantial portion of our assets, certain of our Key Managerial Personnel and officers are also located in India. As a result, it may not be possible for investors to effect service of process upon our Company or such persons in jurisdictions outside India, or to enforce judgments obtained against such parties outside India. Furthermore, it is unlikely that an Indian court would enforce foreign judgments if that court was of the view that the amount of damages awarded was excessive or inconsistent with public policy, or if judgments are in breach or contrary to Indian law. In addition, a party seeking to enforce a foreign judgment in India is required to obtain approval from the RBI to execute such a judgment or to repatriate outside India any amounts recovered.

Recognition and enforcement of foreign judgments is provided for under Section 13 and Section 44A of the Code of Civil Procedure, 1908. India is not party to any international treaty in relation to the recognition or enforcement of foreign judgments. India has reciprocal recognition and enforcement of judgments in civil and commercial matters with only a limited number of jurisdictions, such as the United Kingdom, United Arab Emirates, Singapore and Hong Kong. In order to be enforceable, a judgment from a jurisdiction with reciprocity must meet certain requirements established in the Indian Code of Civil Procedure, 1908. The CPC only permits the enforcement and execution of monetary decrees in the reciprocating jurisdiction, not being in the nature of any amounts payable in respect of taxes, other charges, fines or penalties. Judgments or decrees from jurisdictions which do not have reciprocal recognition with India, including the United States, cannot be enforced by proceedings in execution in India. Therefore, a final judgment for the payment of money rendered by any court in a non-reciprocating territory for civil liability, whether or not predicated solely upon the general laws of the non-reciprocating territory, would not be directly enforceable in India. The party in whose favour a final foreign judgment in a non-reciprocating territory is rendered may bring a fresh suit in a competent court in India based on the final judgment within three years of obtaining such final judgment. However, it is unlikely that a court in India would award damages on the same basis as a foreign court if an action were brought in India or that an Indian court would enforce foreign judgments if it viewed the amount of damages as excessive or inconsistent with the public policy in India. Further, there is no assurance that a suit brought in an Indian court in relation to a foreign judgment will be disposed of in a timely manner. In addition, any person seeking to enforce a foreign judgment in India is required to obtain the prior approval of the RBI to repatriate any amount recovered, and we cannot assure that such approval will be forthcoming within a reasonable period of time, or at all, or that conditions of such approval would be acceptable. Such amount may also be subject to income tax in accordance with applicable law.

Judgments or decrees from jurisdictions which do not have reciprocal recognition with India cannot be enforced by proceedings in execution in India. The United States and India do not currently have a treaty providing for reciprocal recognition and enforcement of judgments in civil and commercial matters. A final judgment for the payment of money rendered by any court in a non-reciprocating territory for civil liability, whether or not predicated solely upon the general laws of the non-reciprocating territory, would not be enforceable in India. Even if an investor obtained a judgment in such a jurisdiction against us, our officers or directors, it may be required to institute a new proceeding in India and obtain a decree from an Indian court. Any such suit must be brought in

India within three years from the date of the judgment in the same manner as any other suit filed to enforce a civil liability in India.

**58. *The trading volume and market price of the Equity Shares may be volatile following the Offer.***

The market price of the Equity Shares may fluctuate as a result of, among other things, the following factors, some of which are beyond our control:

- quarterly variations in our results of operations;
- results of operations that vary from the expectations of securities analysts and investors;
- results of operations that vary from those of our competitors;
- changes in expectations as to our future financial performance, including financial estimates by research analysts and investors;
- a change in research analysts' recommendations;
- announcements by us or our competitors of significant acquisitions, strategic alliances, joint operations or capital commitments;
- announcements by third parties or governmental entities of significant claims or proceedings against us;
- new laws and governmental regulations applicable to our industry;
- additions or departures of key management personnel;
- changes in exchange rates;
- fluctuations in stock market prices and volume; and
- general economic and stock market conditions.

Changes in relation to any of the factors listed above could adversely affect the price of the Equity Shares.

**59. *Fluctuation in the exchange rate between the Indian Rupee and foreign currencies may have an adverse effect on the value of our Equity Shares, independent of our operating results.***

On listing, our Equity Shares will be quoted in Indian Rupees on the Stock Exchanges. Any dividends in respect of our Equity Shares will also be paid in Indian Rupees and subsequently converted into the relevant foreign currency for repatriation, if required. Any adverse movement in currency exchange rates during the time taken for such conversion may reduce the net dividend to foreign investors. In addition, any adverse movement in currency exchange rates during a delay in repatriating the proceeds from a sale of Equity Shares outside India, for example, because of a delay in regulatory approvals that may be required for the sale of Equity Shares may reduce the proceeds received by Shareholders. For example, the exchange rate between the Indian Rupee and the U.S. dollar has fluctuated substantially in recent years and may continue to fluctuate substantially in the future, which may have an adverse effect on the returns on our Equity Shares, independent of our operating results.

**60. *The Offer Price of the Equity Shares may not be indicative of the market price of the Equity Shares after the Offer.***

The Offer Price of the Equity Shares will be determined by our Company and the Investor Selling Shareholders in consultation with the Book Running Lead Managers through the Book Building Process. This price will be based on numerous factors, as described under "***Basis of Offer Price***" on page 105 and may not be indicative of the market price for the Equity Shares after the Offer. The market price of the Equity Shares could be subject to significant fluctuations after the Offer, and may decline below the Offer Price. We cannot assure you that you will be able to resell their Equity Shares at or above the Offer Price.

**61. *Investors may be subject to Indian taxes arising out of capital gains on the sale of the Equity Shares.***

Under current Indian tax laws, unless specifically exempted, capital gains arising from the sale of equity shares in an Indian company is generally taxable in India. A securities transaction tax ("***STT***") is levied on and collected by an Indian stock exchange on which equity shares are sold. Any gain realized on the sale of listed equity shares held for more than 12 months may be subject to long-term capital gains tax in India at the specified rates depending on certain factors, such as STT paid, the quantum of gains and any available treaty exemptions. Accordingly, you may be subject to payment of long-term capital gains tax in India, in addition to payment of STT, on the sale of any Equity Shares held for more than 12 months. STT will be levied on and collected by a domestic stock exchange on which the Equity Shares are sold. Further, any gain realized on the sale of our Equity Shares held for a period of 12 months or less will be subject to short-term capital gains tax in India. While non-residents may claim tax

treaty benefits in relation to such capital gains income, generally, Indian tax treaties do not limit India's right to impose tax on capital gains arising from the sale of shares of an Indian company.

The Finance Act, 2020 ("**Finance Act 2020**") had stipulated that the sale, transfer and issue of certain securities through exchanges, depositories or otherwise to be charged with stamp duty. The Finance Act 2020 also clarified that, in the absence of a specific provision under an agreement, the liability to pay stamp duty in case of sale of certain securities through stock exchanges will be on the buyer, while in other cases of transfer for consideration through a depository, the onus will be on the transferor. The stamp duty for transfer of certain securities, other than debentures, on a delivery basis is currently specified under the Finance Act 2020 at 0.015% and on a non-delivery basis is specified at 0.003% of the consideration amount. These amendments have come into effect from July 1, 2020. Under the Finance Act 2020, any dividends paid by an Indian company will be subject to tax in the hands of the shareholders at applicable rates. Such taxes will be withheld by the Indian company paying dividends. Further, the Finance Act, 2021 ("**Finance Act 2021**"), which followed, removed the requirement for DDT to be payable in respect of dividends declared, distributed or paid by a domestic company after March 31, 2020, and accordingly, such dividends would not be exempt in the hands of the shareholders, both resident as well as non-resident. The Company may or may not grant the benefit of a tax treaty (where applicable) to a non-resident shareholder for the purposes of deducting tax at source pursuant to any corporate action including dividends. Investors are advised to consult their own tax advisors and to carefully consider the potential tax consequences of owning Equity Shares.

More recently, the Government of India announced the union budget for Fiscal 2023, following which the Finance Bill, 2022 ("**Finance Bill 2022**") was introduced in the Lok Sabha on February 1, 2022. Subsequently, the Finance Bill 2022 received the assent from the President of India on March 30, 2022, and became the Finance Act, 2022 ("**Finance Act 2022**"). We cannot predict whether the amendments made pursuant to the Finance Act 2022 would have an adverse effect on our business, financial condition, future cash flows and results of operations. Unfavourable changes in or interpretations of existing, or the promulgation of new, laws, rules and regulations including foreign investment and stamp duty laws governing our business and operations could result in us being deemed to be in contravention of such laws and may require us to apply for additional approvals.

**62. *There is no guarantee that our Equity Shares will be listed on the stock exchanges in a timely manner or at all.***

In accordance with Indian law and practice, permission for listing and trading of our Equity Shares will not be granted until after certain actions have been completed in relation to this Offer and until Allotment of Equity Shares pursuant to this Offer.

In accordance with current regulations and circulars issued of SEBI, our Equity Shares are required to be listed on the stock exchanges within such time as mandated under UPI Circulars, subject to any change in the prescribed timeline in this regard. However, we cannot assure you that the trading in our Equity Shares will commence in a timely manner or at all. Any failure or delay in obtaining final listing and trading approvals may restrict your ability to dispose of your Equity Shares.

**63. *Investors will not be able to sell immediately on an Indian stock exchange any of the Equity Shares they purchase in the Offer.***

The Equity Shares will be listed on the Stock Exchanges. Pursuant to applicable Indian laws, certain actions must be completed before the Equity Shares can be listed and trading in the Equity Shares may commence. Investors' book entry, or 'demat' accounts with depository participants in India, are expected to be credited within one working day of the date on which the Basis of Allotment is approved by the Stock Exchanges. The Allotment of Equity Shares in the Offer and the credit of such Equity Shares to the applicant's demat account with depository participant could take approximately five Working Days from the Bid/ Offer Closing Date and trading in the Equity Shares upon receipt of final listing and trading approvals from the Stock Exchanges is expected to commence within six Working Days of the Bid/ Offer Closing Date. There could be a failure or delay in listing of the Equity Shares on the Stock Exchanges. Any failure or delay in obtaining the approval or otherwise commence trading in the Equity Shares would restrict investors' ability to dispose of their Equity Shares. There can be no assurance that the Equity Shares will be credited to investors' demat accounts, or that trading in the Equity Shares will commence, within the time periods specified in this risk factor. We could also be required to pay interest at the applicable rates if allotment is not made, refund orders are not dispatched or demat credits are not made to investors within the prescribed time periods.



**64. Any future issuance of Equity Shares, or convertible securities or other equity linked instruments by us may dilute your shareholding and sale of Equity Shares by shareholders with significant shareholding may adversely affect the trading price of the Equity Shares.**

We may be required to finance our growth through future equity offerings. Any future equity issuances by us, including a primary offering of Equity Shares, convertible securities or securities linked to Equity Shares including through exercise of employee stock options, may lead to the dilution of investors' shareholdings in our Company. Any future equity issuances by us or sales of our Equity Shares by our shareholders may adversely affect the trading price of the Equity Shares, which may lead to other adverse consequences including difficulty in raising capital through offering of our Equity Shares or incurring additional debt. In addition, any perception by investors that such issuances or sales might occur may also affect the market price of our Equity Shares. Additionally, the disposal, pledge or encumbrance of the Equity Shares by any of our significant shareholders, or the perception that such transactions may occur, may affect the trading price of the Equity Shares. There can be no assurance that we will not issue Equity Shares, convertible securities or securities linked to Equity Shares or that our Shareholders will not dispose of, pledge or encumber their Equity Shares in the future. Any future issuances could also dilute the value of a shareholder's investment in the Equity Shares and adversely affect the trading price of our Equity Shares. Such securities may also be issued at prices below the Offer Price.

**65. Under Indian law, foreign investors are subject to investment restrictions that limit our ability to attract foreign investors, which may adversely affect the trading price of the Equity Shares.**

Under foreign exchange regulations currently in force in India, transfer of shares between non-residents and residents are freely permitted (subject to compliance with sectoral norms and certain other restrictions), if they comply with the pricing guidelines and reporting requirements specified by the RBI. If the transfer of shares, which are sought to be transferred, is not in compliance with such pricing guidelines or reporting requirements or falls under any of the exceptions referred to above, then a prior regulatory approval will be required. Additionally, shareholders who seek to convert Rupee proceeds from a sale of shares in India into foreign currency and repatriate that foreign currency from India require a no-objection or a tax clearance certificate from the Indian income tax authorities.

In addition, pursuant to the Press Note No. 3 (2020 Series), dated April 17, 2020, issued by the DPIIT, which has been incorporated as the proviso to Rule 6(a) of the FEMA Rules, all investments under the foreign direct investment route by entities of a country which shares land border with India or where the beneficial owner of the Equity Shares is situated in or is a citizen of any such country, can only be made through the Government approval route, as prescribed in the Consolidated FDI Policy dated October 15, 2020 and the FEMA Rules. Further, in the event of transfer of ownership of any existing or future foreign direct investment in an entity in India, directly or indirectly, resulting in the beneficial ownership falling within the aforesaid restriction/purview, such subsequent change in the beneficial ownership will also require approval of the Government of India. Furthermore, on April 22, 2020, the Ministry of Finance, Government of India, has also made similar amendment to the FEMA Rules. While the term "beneficial owner" is defined under the Prevention of Money-Laundering (Maintenance of Records) Rules, 2005 and the General Financial Rules, 2017, neither the foreign direct investment policy nor the FEMA Rules provide a definition of the term "beneficial owner". The interpretation of "beneficial owner" and enforcement of this regulatory change involves certain uncertainties, which may have an adverse effect on our ability to raise foreign capital.

We cannot assure investors that any required approval from the RBI or any other governmental agency can be obtained on any particular terms or at all. For further information, see "*Restrictions on Foreign Ownership of Indian Securities*" on page 435.

**66. Significant differences exist between Ind AS and other accounting principles, such as U.S. GAAP and IFRS, which investors may be more familiar with and may consider material to their assessment of our financial condition.**

Our Restated Financial Statements for Fiscal 2019, 2020 and 2021 and the nine months ended December 31, 2021, have been prepared and presented in conformity with Ind AS. Ind AS differs in certain significant respects from Indian GAAP, IFRS, U.S. GAAP and other accounting principles with which prospective investors may be familiar in other countries. If our financial statements were to be prepared in accordance with such other accounting principles, our results of operations, cash flows and financial position may be substantially different. Prospective investors should review the accounting policies applied in the preparation of our financial statements and consult their own professional advisers for an understanding of the differences between these accounting principles and those with which they may be more familiar. Any reliance by persons not familiar with Indian

accounting practices on the financial disclosures presented in this Draft Red Herring Prospectus should be limited accordingly.

- 67. *The determination of the Price Band is based on various factors and assumptions and the Offer Price of the Equity Shares may not be indicative of the market price of the Equity Shares after the Offer. Further, the current market price of some securities listed pursuant to certain previous issues managed by the BRLMs is below their respective issue prices.***

The determination of the Price Band is based on various factors and assumptions, and will be determined by our Company and the Investor Selling Shareholders in consultation with the BRLMs. Furthermore, the Offer Price of the Equity Shares will be determined by our Company and the Investor Selling Shareholders in consultation with the BRLMs through the Book Building Process. These will be based on numerous factors, including factors as described under “*Basis of Offer Price*” on page 105 and may not be indicative of the market price for the Equity Shares after the Offer.

In addition to the above, the current market price of securities listed pursuant to certain previous initial public offerings managed by the BRLMs is below their respective issue price. For further information, see “*Other Regulatory and Statutory Disclosures – Price information of past issues handled by the BRLMs*” on page 401. The factors that could affect the market price of the Equity Shares include, among others, broad market trends, financial performance and results of our Company post-listing, and other factors beyond our control. We cannot assure you that an active market will develop or sustained trading will take place in the Equity Shares or provide any assurance regarding the price at which the Equity Shares will be traded after listing.

- 68. *QIBs and Non-Institutional Investors are not permitted to withdraw or lower their Bids (in terms of quantity of Equity Shares or the Bid amount) at any stage after submitting a bid, and Retail Individual Bidders are not permitted to withdraw their Bids after Bid/Offer Closing Date.***

Pursuant to the SEBI ICDR Regulations, QIBs and Non-Institutional Investors are required to block the Bid amount on submission of the Bid and are not permitted to withdraw or lower their Bids (in terms of quantity of equity shares or the Bid Amount) at any stage after submitting a Bid. Similarly, Retail Individual Bidders can revise or withdraw their Bids at any time during the Bid/Offer Period and until the Bid/ Offer Closing date, but not thereafter. While we are required to complete all necessary formalities for listing and commencement of trading of the Equity Shares on all Stock Exchanges where such Equity Shares are proposed to be listed, including Allotment, within six Working Days from the Bid/ Offer Closing Date or such other period as may be prescribed by the SEBI, events affecting the investors’ decision to invest in the Equity Shares, including adverse changes in international or national monetary policy, financial, political or economic conditions, our business, results of operations, cash flows or financial condition may arise between the date of submission of the Bid and Allotment.

We may complete the Allotment of the Equity Shares even if such events occur, and such events may limit the investors’ ability to sell the Equity Shares Allotted pursuant to the Offer or cause the trading price of the Equity Shares to decline on listing. Therefore, QIBs and Non-Institutional Investors will not be able to withdraw or lower their bids following adverse developments in international or national monetary policy, financial, political or economic conditions, our business, results of operations, cash flows or otherwise between the dates of submission of their Bids and Allotment.

- 69.  *Holders of Equity Shares may be restricted in their ability to exercise pre-emptive rights under Indian law and thereby may suffer future dilution of their ownership position.***

Under the Companies Act, a company having share capital and incorporated in India must offer its holders of equity shares pre-emptive rights to subscribe and pay for a proportionate number of equity shares to maintain their existing ownership percentages before the issuance of any new equity shares, unless the pre-emptive rights have been waived by adoption of a special resolution. However, if the laws of the jurisdiction the investors are located in does not permit them to exercise their pre-emptive rights without our filing an offering document or registration statement with the applicable authority in such jurisdiction, the investors will be unable to exercise their pre-emptive rights unless we make such a filing. If we elect not to file a registration statement, the new securities may be issued to a custodian, who may sell the securities for the investor’s benefit. The value the custodian receives on the sale of such securities and the related transaction costs cannot be predicted. In addition, to the extent that the investors are unable to exercise pre-emption rights granted in respect of the Equity Shares held by them, their proportional interest in us would be reduced.

**70. *A third-party could be prevented from acquiring control of us post this Offer, because of anti-takeover provisions under Indian law.***

As a listed Indian entity, there are provisions in Indian law that may delay, deter or prevent a future takeover or change in control of our Company. Under the Takeover Regulations, an acquirer has been defined as any person who, directly or indirectly, acquires or agrees to acquire shares or voting rights or control over a company, whether individually or acting in concert with others. Although these provisions have been formulated to ensure that interests of investors/shareholders are protected, these provisions may also discourage a third party from attempting to take control of our Company subsequent to completion of the Offer. Consequently, even if a potential takeover of our Company would result in the purchase of the Equity Shares at a premium to their market price or would otherwise be beneficial to our shareholders, such a takeover may not be attempted or consummated because of Takeover Regulations.

**71. *Rights of shareholders of companies under Indian law may be more limited than under the laws of other jurisdictions.***

Our Articles of Association, composition of our Board, Indian laws governing our corporate affairs, the validity of corporate procedures, directors' fiduciary duties, responsibilities and liabilities, and shareholders' rights may differ from those that would apply to a company in another jurisdiction. Shareholders' rights under Indian law may not be as extensive and wide-spread as shareholders' rights under the laws of other countries or jurisdictions. Investors may face challenges in asserting their rights as shareholder of our Company than as a shareholder of an entity in another jurisdiction.

**72. *Our customers may engage in transactions in or with countries or persons that are subject to U.S. and other sanctions.***

U.S. law generally prohibits U.S. persons from directly or indirectly investing or otherwise doing business in or with certain countries that are the subject of comprehensive sanctions and with certain persons or businesses that have been specially designated by the OFAC or other U.S. government agencies. Other governments and international or regional organisations also administer similar economic sanctions. We may enter into transactions with customers who may be doing business with, or located in, countries to which certain OFAC-administered and other sanctions apply. There can be no assurance that we will be able to fully monitor all of our transactions for any potential violation. If it were determined that transactions in which we participate violate U.S. or other sanctions, we could be subject to U.S. or other penalties, and our reputation and future business prospects in the United States or with U.S. persons, or in other jurisdictions, could be adversely affected. We rely on our staff to be up-to-date and aware of the latest sanctions in place. Further, investors in the Equity Shares could incur reputational or other risks as the result of our customers' dealings in or with countries or with persons that are the subject of U.S. sanctions.

**73. *Compliance with provisions of Foreign Account Tax Compliance Act may affect payments on the Equity Shares.***

The U.S. "Foreign Account Tax Compliance Act" (or "FATCA") imposes a new reporting regime and potentially, imposes a 30% withholding tax on certain "foreign passthru payments" made by certain non-U.S. financial institutions (including intermediaries). If payments on the Equity Shares are made by such non-U.S. financial institutions (including intermediaries), this withholding may be imposed on such payments if made to any non-U.S. financial institution (including an intermediary) that is not otherwise exempt from FATCA or other holders who do not provide sufficient identifying information to the payer, to the extent such payments are considered "foreign passthru payments". Under current guidance, the term "foreign passthru payment" is not defined and it is therefore not clear whether and to what extent payments on the Equity Shares would be considered "foreign passthru payments". The United States has entered into intergovernmental agreements with many jurisdictions (including India) that modify the FATCA withholding regime described above. It is not yet clear how the intergovernmental agreements between the United States and these jurisdictions will address "foreign passthru payments" and whether such agreements will require us or other financial institutions to withhold or report on payments on the Equity Shares to the extent they are treated as "foreign passthru payments". Prospective investors should consult their tax advisors regarding the consequences of FATCA, or any intergovernmental agreement or non-U.S. legislation implementing FATCA, to their investment in Equity Shares.

**74. *U.S. holders should consider the impact of the passive foreign investment company rules in connection with an investment in our Equity Shares.***

A foreign corporation will be treated as a passive foreign investment company (“**PFIC**”) for U.S. federal income tax purposes for any taxable year in which either: (i) at least 75% of its gross income is “passive income” or (ii) at least 50% of its gross assets during the taxable year (based on of the quarterly values of the assets during a taxable year) are “passive assets,” which generally means that they produce passive income or are held for the production of passive income.

No assurance can be given that our Company will or will not be considered a PFIC in the current or future years. The determination of whether or not our Company is a PFIC is a factual determination that is made annually after the end of each taxable year, and there can be no assurance that our Company will not be considered a PFIC in the current taxable year or any future taxable year because, among other reasons, (i) the composition of our Company’s income and assets will vary over time, and (ii) the manner of the application of relevant rules is uncertain in several respects. Further, our Company’s PFIC status may depend on the market price of its Equity Shares, which may fluctuate considerably.

### SECTION III – INTRODUCTION

#### SUMMARY FINANCIAL INFORMATION

The following tables set forth summary financial information derived from our Restated Financial Statements. The summary financial information presented below should be read in conjunction with “*Financial Statements*” and “*Management’s Discussion and Analysis of Financial Condition and Results of Operations*” on pages 212 and 355, respectively.

*[Remainder of this page intentionally kept blank]*

**Uniparts India Limited**
**Annexure I - Restated Consolidated Statement of Assets and Liabilities**

(All amounts are in Rs. million, unless stated otherwise)

	Particulars	Annexure V Note	As at 31st December 2021	As at 31st March 2021	As at 31st March 2020	As at 31st March 2019
<b>I</b>	<b>ASSETS</b>					
	<b>NON-CURRENT ASSETS</b>					
	Property, plant and equipment	3(a)	2,013.68	2,001.91	2,069.96	2,179.84
	Right of use assets	3(b)	529.23	578.00	662.40	749.18
	Capital work-in-progress	3(c)	57.51	22.87	93.21	58.75
	Goodwill		612.30	590.01	597.87	601.66
	Other intangible assets	3(d)	39.85	54.23	68.26	24.33
	Intangible assets under development	3(e)	-	-	6.30	30.02
	Financial assets					
	Other financial assets	4	46.24	44.49	50.48	51.40
	Current tax assets (Net) - non current		68.60	112.84	112.27	126.51
	Other non-current assets	5	18.50	22.32	4.46	27.46
	<b>Total non-current assets</b>		<b>3,385.91</b>	<b>3,426.67</b>	<b>3,665.21</b>	<b>3,849.15</b>
	<b>CURRENT ASSETS</b>					
	Inventories	6	4,545.71	3,390.79	3,529.17	3,674.66
	Financial assets					
	Investments	7	17.58	12.50	-	-
	Trade receivables	8	1,613.74	1,675.32	1,228.35	1,453.58
	Cash and cash equivalents	9	131.73	108.18	169.21	78.51
	Other balances with banks	9	-	-	0.35	72.42
	Derivative instruments		45.44	35.38	-	14.70
	Loans	10	3.77	3.44	1.70	4.90
	Other financial assets	4	0.32	0.33	0.33	0.40
	Other current assets	5	328.33	280.09	393.15	436.05
	<b>Total current assets</b>		<b>6,686.62</b>	<b>5,506.03</b>	<b>5,322.26</b>	<b>5,735.22</b>
	<b>TOTAL ASSETS</b>		<b>10,072.53</b>	<b>8,932.70</b>	<b>8,987.47</b>	<b>9,584.37</b>

**Uniparts India Limited**
**Annexure I - Restated Consolidated Statement of Assets and Liabilities**

(All amounts are in Rs. million, unless stated otherwise)

	Particulars	Annexure V Note	As at 31st December 2021	As at 31st March 2021	As at 31st March 2020	As at 31st March 2019
<b>II</b>	<b>EQUITY AND LIABILITIES</b>					
	<b>EQUITY</b>					
	Equity share capital	11	446.20	446.20	446.20	446.20
	Other equity	12	6,213.42	5,147.61	4,195.45	3,773.61
	<b>Total equity</b>		<b>6,659.62</b>	<b>5,593.81</b>	<b>4,641.65</b>	<b>4,219.81</b>
	<b>LIABILITIES</b>					
	<b>NON-CURRENT LIABILITIES</b>					
	Financial liabilities					
	Borrowings	13	15.14	57.17	216.12	475.15
	Lease liabilities	14	249.30	278.57	346.62	389.54
	Provisions	15	161.92	156.12	138.25	133.83
	Deferred tax liabilities (Net)	16	242.47	275.61	241.48	273.55
	Other non-current liabilities	17	9.93	9.31	8.82	5.63
	<b>Total non-current liabilities</b>		<b>678.76</b>	<b>776.78</b>	<b>951.29</b>	<b>1,277.70</b>
	<b>CURRENT LIABILITIES</b>					
	Financial liabilities					
	Borrowings	13	1,394.44	1,220.60	2,348.85	2,981.13
	Lease liabilities	14	52.53	65.32	72.42	73.39
	Derivative instruments		-	-	54.49	-
	Trade payables due to:					
	Micro and small enterprises	18	391.97	380.06	146.36	125.90
	Other than micro and small enterprises	18	468.67	520.86	380.45	572.46
	Other liabilities	17	286.24	270.78	321.13	262.62
	Provisions	15	51.90	54.73	63.07	64.87
	Current tax liabilities (Net)		88.40	49.76	7.76	6.49
	<b>Total current liabilities</b>		<b>2,734.15</b>	<b>2,562.11</b>	<b>3,394.53</b>	<b>4,086.86</b>
	<b>Total liabilities</b>		<b>3,412.91</b>	<b>3,338.89</b>	<b>4,345.82</b>	<b>5,364.56</b>
	<b>TOTAL EQUITY AND LIABILITIES</b>		<b>10,072.53</b>	<b>8,932.70</b>	<b>8,987.47</b>	<b>9,584.37</b>

The above Restated Consolidated Statement of Assets and Liabilities should be read in conjunction with Notes to the Restated Consolidated Financial Information appearing in Annexure - V and Summary of Restatement Adjustments appearing in Annexure - VI.

Uniparts India Limited

Annexure II - Restated Consolidated Statement of Profit and Loss

(All amounts are in Rs. million, unless stated otherwise)

	Particulars	Annexure V Note	For the period ended 31st December 2021	For the year ended 31st March 2021	For the year ended 31st March 2020	For the year ended 31st March 2019
I	Revenue from operations	19	8,808.92	9,031.42	9,072.20	10,605.66
II	Other income	20	32.97	445.47	316.18	19.12
III	<b>Total income (I+II)</b>		<b>8,841.89</b>	<b>9,476.89</b>	<b>9,388.38</b>	<b>10,624.78</b>
IV	<b>Expenses</b>					
	Cost of materials consumed	21	3,862.24	3,381.77	3,323.20	4,282.84
	Changes in inventories of finished goods, work-in-progress, stock-in-trade and scrap	22	(1,121.17)	147.13	(35.34)	(559.60)
	Employee benefits expense	23	1,605.86	1,854.48	2,117.62	2,217.42
	Finance costs	24	42.28	81.07	179.65	181.98
	Depreciation and amortization expenses	25	271.66	372.59	354.42	300.96
	Other expenses	26	2,481.48	2,454.25	2,704.80	3,285.64
	<b>Total expenses (IV)</b>		<b>7,142.35</b>	<b>8,291.29</b>	<b>8,644.35</b>	<b>9,709.24</b>
V	<b>Restated profit before tax (III-IV)</b>		<b>1,699.54</b>	<b>1,185.60</b>	<b>744.03</b>	<b>915.54</b>
VI	<b>Tax expense</b>					
	Current tax	27	512.01	245.54	127.53	203.76
	MAT credit	27	-	-	19.06	(4.60)
	Deferred tax	27	(35.83)	16.20	(28.98)	20.41
	<b>Total tax expenses (VI)</b>		<b>476.18</b>	<b>261.74</b>	<b>117.61</b>	<b>219.57</b>
VII	<b>Restated profit for the period / year (V- VI)</b>		<b>1,223.36</b>	<b>923.86</b>	<b>626.42</b>	<b>695.97</b>



**Uniparts India Limited**

**Annexure II - Restated Consolidated Statement of Profit and Loss**

(All amounts are in Rs. million, unless stated otherwise)

	Particulars	Annexure V Note	For the period ended 31st December 2021	For the year ended 31st March 2021	For the year ended 31st March 2020	For the year ended 31st March 2019
<b>VIII</b>	<b>Restated other comprehensive income / (loss)</b>					
	<b>Items that will not be reclassified to Profit or Loss</b>					
	Re-measurement gains / (losses) of defined benefit plans		(12.24)	0.69	9.45	(10.60)
	Income tax relating to items that will not be reclassified to profit/loss		3.08	(0.17)	(2.41)	3.50
	<b>Items that will be reclassified to profit or loss</b>					
	Effective portion of cash flow hedge		10.06	89.87	(69.19)	14.70
	Exchange differences in translating the financial statements of foreign operations		(14.83)	(43.50)	(101.55)	(73.63)
	Income tax relating to items that will be reclassified to profit/loss		(2.53)	(22.62)	17.41	(5.14)
	<b>Restated other comprehensive income / (loss) for the period / year, net of tax</b>		<b>(16.46)</b>	<b>24.27</b>	<b>(146.29)</b>	<b>(71.17)</b>
<b>IX</b>	<b>Restated total comprehensive income for the period / year (VII+VIII)</b>		<b>1,206.90</b>	<b>948.13</b>	<b>480.13</b>	<b>624.80</b>
<b>X</b>	<b>Restated earnings per equity share attributable to owners of parent</b>	28				
	Basic earnings per share (in Rs.)		27.73	20.95	14.20	15.78
	Diluted earnings per share (in Rs.)		27.11	20.47	13.88	15.42

The above Restated Consolidated Statement of Profit and Loss should be read in conjunction with Notes to the Restated Consolidated Financial Information appearing in Annexure - V and Summary of Restatement Adjustments appearing in Annexure - VI

**Uniparts India Limited**
**Annexure III - Restated Consolidated Statement of Cash Flows**
**(All amounts are in Rs. million, unless stated otherwise)**

	Particulars	For the period ended 31st December 2021	For the year ended 31st March 2021	For the year ended 31st March 2020	For the year ended 31st March 2019
<b>A</b>	<b>Cash flow from operating activities:</b>				
	<b>Restated profit before tax</b>	1,699.54	1,185.60	744.03	915.54
	<b>Adjustments for:</b>				
	Depreciation and amortization expenses	271.66	372.59	354.42	300.96
	Interest expenses	22.83	53.61	135.99	147.76
	Interest on lease liabilities	11.59	18.20	20.03	10.70
	Interest income	(8.53)	(7.82)	(12.35)	(4.93)
	Deferred tax	(32.59)	11.34	(17.07)	6.39
	Expense on employee stock option scheme	7.85	4.03	5.85	1.99
	Transitional impact of Ind AS 116	-	-	10.57	(9.55)
	Reclassification of cash flow hedge	-	-	-	(1.26)
	(Profit) / loss on sale of property, plant and equipment	0.93	8.23	(62.69)	(0.20)
	Fixed assets written-off	-	0.84	0.73	3.97
	Unrealised foreign exchange (gain)/ loss	(27.40)	(32.85)	13.89	(3.50)
	Exchange difference on translation of assets and liabilities	(48.31)	(29.99)	(147.19)	(106.86)
	<b>Operating profit before working capital changes</b>	<b>1,897.57</b>	<b>1,583.78</b>	<b>1,046.21</b>	<b>1,261.01</b>
	<b>Adjustments for changes in working capital :</b>				
	(Increase)/decrease in loans	(0.33)	(1.74)	3.20	(2.63)
	(Increase)/decrease in other financial assets (non-current)	(1.75)	5.99	0.92	(2.76)
	(Increase)/decrease in other non-current assets	3.82	(17.86)	23.00	27.27
	(Increase)/decrease in inventories	(1,154.92)	138.38	145.49	(632.87)
	(Increase)/decrease in trade receivables	76.29	(434.04)	288.45	(339.45)
	(Increase)/decrease in derivative instruments	-	-	-	1.92
	(Increase)/decrease in other financial assets (current)	0.01	-	0.07	0.23
	(Increase)/decrease in current tax assets (net)	44.24	(0.57)	14.24	(30.10)
	(Increase)/decrease in other current assets	(48.24)	113.06	42.90	(15.40)
	Increase/(decrease) in provisions (non-current)	(6.44)	18.56	13.87	10.26
	Increase/(decrease) in other non-current liabilities	0.62	0.49	3.19	(16.71)
	Increase/(decrease) in trade payables	(39.00)	374.11	(173.02)	(144.24)
	Increase/(decrease) in other current liabilities	22.93	(24.53)	40.29	22.37
	Increase/(decrease) in current tax liabilities	38.64	42.00	1.27	(6.44)
	Increase/(decrease) in provisions (current)	(2.83)	(8.34)	(1.80)	9.54
	<b>Cash generated from/(used in) operations</b>	<b>830.61</b>	<b>1,789.29</b>	<b>1,448.28</b>	<b>142.00</b>

Uniparts India Limited

Annexure III - Restated Consolidated Statement of Cash Flows

(All amounts are in Rs. million, unless stated otherwise)

Particulars	For the period ended 31st December 2021	For the year ended 31st March 2021	For the year ended 31st March 2020	For the year ended 31st March 2019
Less: Income tax (paid) / refunds	(476.18)	(261.74)	(117.61)	(198.51)
<b>Net cash flow from/ (used in) operating activities</b>	<b>354.43</b>	<b>1,527.55</b>	<b>1,330.67</b>	<b>(56.51)</b>
<b>B. Cash flow from investing activities:</b>				
Payments for purchase of property, plant and equipment and capital work in progress	(249.24)	(161.21)	(214.47)	(1,079.90)
Payments for purchase of intangible assets	(2.47)	(2.32)	(30.26)	(21.25)
Proceeds from sale of property, plant and equipment	3.15	10.83	131.27	14.30
Investment in financial instrument	(5.08)	(12.50)	-	-
Interest received	8.53	7.82	12.35	4.93
<b>Net cash flow from/ (used in) investing activities</b>	<b>(245.11)</b>	<b>(157.38)</b>	<b>(101.11)</b>	<b>(1,081.92)</b>
<b>C. Cash flow from financing activities</b>				
Proceeds/(repayment) from short term borrowings	185.25	(1,108.32)	(707.91)	766.36
Proceeds from long term borrowings	-	-	-	350.00
Increase/(decrease) in lease liabilities	(42.06)	(75.15)	(43.89)	462.92
Interest on lease liabilities	(11.59)	(18.20)	(20.03)	(10.70)
Repayment of long term borrowings	(42.03)	(158.95)	(259.03)	(117.83)
Interest paid	(22.83)	(53.61)	(135.99)	(147.76)
Payment of dividend on equity shares (including DDT)	(148.94)	-	(65.29)	(54.41)
<b>Net cash flow from/ (used in) financing activities</b>	<b>(82.20)</b>	<b>(1,414.23)</b>	<b>(1,232.14)</b>	<b>1,248.58</b>

**Uniparts India Limited**

**Annexure III - Restated Consolidated Statement of Cash Flows**

(All amounts are in Rs. million, unless stated otherwise)

Particulars	For the period ended 31st December 2021	For the year ended 31st March 2021	For the year ended 31st March 2020	For the year ended 31st March 2019
Net increase/(decrease) in cash and cash equivalents (A+B+C)	27.12	(44.06)	(2.58)	110.15
Cash and Cash Equivalents at the beginning of the period / year	108.18	169.56	150.93	91.49
Net increase/(decrease) in temporary overdraft	(7.47)	(25.82)	18.22	(53.19)
Effects of exchange difference on cash and cash equivalent held in foreign currency	3.90	8.50	2.99	2.48
<b>Cash and Cash Equivalents as at the end of the period / year (Refer note 9)</b>	<b>131.73</b>	<b>108.18</b>	<b>169.56</b>	<b>150.93</b>
<b>a) The above Restated Consolidated Statement of Cash Flows has been prepared under the “Indirect Method” as set out in the Indian Accounting Standard (Ind AS-7) - “Statement of Cash Flows”.</b>				
<b>b) Components of cash and cash equivalents as at (Refer note 9)</b>				
<b>Cash and cash equivalents comprises :</b>				
Cash in hand	0.84	1.00	1.94	3.28
Balances with banks	130.89	107.18	167.27	75.23
Other bank balances	-	-	0.35	72.42
<b>Total</b>	<b>131.73</b>	<b>108.18</b>	<b>169.56</b>	<b>150.93</b>

**Uniparts India Limited**

**Annexure III - Restated Consolidated Statement of Cash Flows**

(All amounts are in Rs. million, unless stated otherwise)

**c) Disclosure as required by Ind AS 7 - "Cash Flow Statements" - change in liabilities arising from financing activities:-**

<b>Particulars</b>	<b>For the period ended 31st December 2021</b>	<b>For the year ended 31st March 2021</b>	<b>For the year ended 31st March 2020</b>	<b>For the year ended 31st March 2019</b>
<b>Opening balance</b>	1,277.77	2,564.97	3,456.28	2,433.38
<b>Non cash movement</b>				
Exchange (Gain)/Loss	(11.41)	(19.93)	75.63	24.37
Interest Cost	22.83	53.61	135.99	147.76
<b>Cash movement</b>				
Principal repayment of long term borrowings	(42.03)	(158.95)	(259.03)	(117.83)
Proceeds from long term borrowings	-	-	-	350.00
Net short term Borrowing	185.25	(1,108.32)	(707.91)	766.36
Interest Payment	(22.83)	(53.61)	(135.99)	(147.76)
<b>Closing balance</b>	<b>1,409.58</b>	<b>1,277.77</b>	<b>2,564.97</b>	<b>3,456.28</b>

The above Restated Consolidated Statement of Cash Flows should be read in conjunction with Notes to the Restated Consolidated Financial Information appearing in Annexure - V and Summary of Restatement Adjustments appearing in Annexure - VI.

## THE OFFER

The following table summarizes details of the Offer:

<b>Offer</b>	
<i>The Offer consists of:</i>	
Offer for Sale <sup>(1)(2)</sup>	Up to 15,731,942 Equity Shares aggregating up to ₹ [●] million
<i>Of which:</i>	
<b>A. QIB Portion</b> <sup>(3)(4)</sup>	Not more than 7,865,970 Equity Shares aggregating up to ₹ [●] million
<i>Of which:</i>	
Anchor Investor Portion	Up to 4,719,582 Equity Shares
Net QIB (assuming the Anchor Investor Portion is fully subscribed)	Up to 3,146,388 Equity Shares
<i>Of which:</i>	
Available for allocation to Mutual Funds only (5% of the Net QIB Portion)	157,319 Equity Shares
Balance of QIB Portion for all QIBs including Mutual Funds	2,989,069 Equity Shares
<b>B. Non-Institutional Category</b> <sup>(3)(4)</sup>	
Not less than 2,359,792 Equity Shares aggregating up to ₹ [●] million	
<i>Of which:</i>	
One-third of the Non-Institutional Category available for allocation to Bidders with an application size of more than ₹ 200,000 and up to ₹ 1,000,000	786,598 Equity Shares
Two-third of the Non-Institutional Category available for allocation to Bidders with an application size of more than ₹ 1,000,000	1,573,194 Equity Shares
<b>C. Retail Portion</b> <sup>(3)(5)</sup>	
Not less than 5,506,180 Equity Shares aggregating up to ₹ [●] million	
<b>Pre and post-Offer Equity Shares</b>	
Equity Shares outstanding prior to the Offer (as on the date of this Draft Red Herring Prospectus)	45,133,758 Equity Shares
Equity Shares outstanding after the Offer	45,133,758 Equity Shares
<b>Use of proceeds of the Offer</b>	For further information, see “ <i>Objects of the Offer</i> ” beginning on page 103. Our Company will not receive any portion of the proceeds from the Offer.

(1) The Offer has been authorized by a resolution of our Board dated March 30, 2022. Further, our Board has taken on record the approval for the Offer for Sale by the Selling Shareholders pursuant to its resolution dated April 25, 2022.

(2) The Equity Shares being offered by the Selling Shareholders have been held for a period of at least one year immediately preceding the date of this Draft Red Herring Prospectus with SEBI and are eligible for being offered for sale pursuant to the Offer in terms of the SEBI ICDR Regulations. For further information, see “*Capital Structure*” beginning on page 87. The Selling Shareholders, severally and not jointly, have confirmed and authorized their respective participation in the Offer for Sale, as stated below:

S. No.	Name of the Selling Shareholder	Date of consent letter	Date of board resolution/ corporate authorization	Maximum number of Offered Shares
<b>Promoter Group Selling Shareholders</b>				
1.	The Karan Soni 2018 CG-NG Nevada Trust	March 28, 2022	-	1,700,000
2.	The Meher Soni 2018 CG-NG Nevada Trust	March 28, 2022	-	1,700,000
3.	Pamela Soni	March 28, 2022	-	2,250,000
<b>Investor Selling Shareholders</b>				
4.	Ashoka Investment Holdings Limited	April 25, 2022	April 7, 2022	7,180,642
5.	Ambadevi Mauritius Holding Limited	April 25, 2022	April 7, 2022	2,154,192
<b>Individual Selling Shareholders</b>				
6.	Andrew Warren Code	March 10, 2022	-	177,378
7.	James Norman Hallene	March 10, 2022	-	177,378

S. No.	Name of the Selling Shareholder	Date of consent letter	Date of board resolution/ corporate authorization	Maximum number of Offered Shares
8.	Kevin John Code	March 10, 2022	-	177,378
9.	Dennis Francis DeDecker	March 7, 2022	-	57,420
10.	Melvin Keith Gibbs	March 7, 2022	-	41,730
11.	Walter James Gruber	March 28, 2022	-	24,706
12.	Wendy Reichard Hammen	March 9, 2022	-	21,556
13.	Mark Louis Dawson	March 28, 2022	-	20,870
14.	Bradley Lorenz Miller	March 8, 2022	-	16,366
15.	Mary Louise Arp	March 28, 2022	-	10,440
16.	Diana Lynn Craig	March 8, 2022	-	8,340
17.	Marc Christopher Dorau	March 9, 2022	-	7,710
18.	Craig A Johnson	March 28, 2022	-	5,010
19.	Misty Marie Garcia	March 28, 2022	-	826
<b>Total</b>				<b>15,731,942</b>

- (3) *Subject to valid bids being received at or above the Offer Price, under subscription, if any, in any category, except in the QIB Portion, would be allowed to be met with spill-over from any other category or combination of categories of Bidders, as applicable, at the discretion of our Company, in consultation with the BRLMs and the Designated Stock Exchange, subject to applicable laws. Undersubscription, if any, in the QIB Portion (excluding the Anchor Investor Portion) will not be allowed to be met with spill-over from other categories or a combination of categories.*
- (4) *Not less than 15% of the Offer shall be available for allocation to Non-Institutional Investors of which one-third of the Non-Institutional Category will be available for allocation to Bidders with an application size of more than ₹ 200,000 and up to ₹ 1,000,000 and two-thirds of the Non-Institutional Category will be available for allocation to Bidders with an application size of more than ₹ 1,000,000 and under-subscription in either of these two sub-categories of Non-Institutional Category may be allocated to Bidders in the other sub-category of Non-Institutional Category.*
- (5) *Our Company and the Investor Selling Shareholders, in consultation with the BRLMs, may allocate up to 60% of the QIB Portion to Anchor Investors on a discretionary basis in accordance with the SEBI ICDR Regulations. One-third of the Anchor Investor Portion shall be reserved for domestic Mutual Funds, subject to valid Bids being received from domestic Mutual Funds at or above the price at which Equity Shares are allocated to Anchor Investors in the Offer. In the event of under-subscription, or non-allocation in the Anchor Investor Portion, the balance Equity Shares shall be added to the QIB Portion. For further information, see “Offer Procedure” beginning on page 417.*

Allocation to all categories of Bidders, other than Anchor Investors, if any, Retail Individual Investors and Non-Institutional Investors, shall be made on a proportionate basis, subject to valid Bids received at or above the Offer Price, as applicable. The allocation to each Retail Individual Investor and Non-Institutional Investor shall not be less than the minimum Bid Lot, subject to availability of Equity Shares in the Retail Category and the Non-Institutional Category and the remaining available Equity Shares, if any, shall be allocated on a proportionate basis. Our Company will not receive any proceeds from the Offer for Sale. For further information, see “Offer Procedure” beginning on page 417.

## GENERAL INFORMATION

Our Company was incorporated as “Uniparts India Limited” under the Companies Act, 1956 at Delhi, pursuant to a certificate of incorporation dated September 26, 1994 issued by the RoC. Our Company received a certificate of commencement of business on September 7, 1998 from the RoC.

### Corporate identity number and registration number

**Corporate Identity Number:** U74899DL1994PLC061753

**Registration Number:** 061753

### Registered Office

Gripwel House Block – 5  
Sector C 6 & 7 Vasant Kunj  
New Delhi 110 070, India  
**Tel:** +91 11 2613 7979  
**E-mail:** compliance.officer@unipartsgroup.com  
**Website:** www.unipartsgroup.com

### Corporate Office

1<sup>st</sup> Floor, B208  
A1 & A2, Phase-II  
Noida 201 305  
Uttar Pradesh, India  
**Tel:** +91 120 458 1400  
**E-mail:** compliance.officer@unipartsgroup.com  
**Website:** www.unipartsgroup.com

### Address of the Registrar of Companies

Our Company is registered with the RoC located at the following address:

### Registrar of Companies, Delhi and Haryana at Delhi

4<sup>th</sup> Floor, IFCI Tower  
61, Nehru Place  
New Delhi 110 019, India

### Board of Directors

The following table sets out the details regarding our Board as on the date of filing of this Draft Red Herring Prospectus:

Name	Designation	DIN	Address
Gurdeep Soni	Chairman and Managing Director	00011478	142 Church Road, Avenue-7, Vasant Kunj, South West Delhi, Delhi 110 070, India
Paramjit Singh Soni	Executive Director and Vice Chairman	00011616	596, High Hampton, Dr. Martinez, GA 30907 9183, USA
Herbert Coenen	Non-Executive Director	00916001	Vinxeler Street, 74A, Koenigswinter, 53639, Germany
Harjit Singh Bhatia*	Nominee Director	02285424	18, Bishopsgate, Singapore, Singapore 249981
Alok Nagory	Independent Director	00478140	7/197, Swarup Nagar, Kanpur 208 002, India
Sharat Krishan Mathur	Independent Director	01217742	E-323/2, Greater Kailash – I, New Delhi 110 048, India
Shradha Suri	Independent Director	00176902	N-101, Panchsheel Park, New Delhi 110 017, India
Sanjeev Kumar Chanana	Independent Director	00112424	House No-B 5/6, Africa Avenue, Safdarjung Enclave, Vasant Vihar, South West Delhi, Delhi 110 029, India

\*As a nominee of Ashoka and Ambadevi.



For brief profiles and further details in respect of our Directors, see “*Our Management*” on page 189.

### **Company Secretary and Compliance Officer**

Jatin Mahajan is the Company Secretary and Compliance Officer of our Company. His contact details are as follows:

1<sup>st</sup> Floor, B208  
A1 & A2, Phase-II  
Noida 201 305  
Uttar Pradesh, India  
**Tel:** +91 120 458 1400  
**E-mail:** compliance.officer@unipartsgroup.com

### **Investor Grievances**

**Investors may contact the Company Secretary and Compliance Officer or the Registrar to the Offer in case of any pre-Offer or post-Offer related grievances including non-receipt of letters of Allotment, non-credit of Allotted Equity Shares in the respective beneficiary account, non-receipt of refund orders or non-receipt of funds by electronic mode, etc. For all Offer related queries and for redressal of complaints, Investors may also write to the BRLMs.**

All Offer-related grievances, other than that of Anchor Investors may be addressed to the Registrar to the Offer with a copy to the relevant Designated Intermediary(ies) with whom the Bid cum Application Form was submitted, giving full details such as name of the sole or First Bidder, Bid cum Application Form number, Bidder’s DP ID, Client ID, PAN, address of Bidder, number of Equity Shares applied for, ASBA Account number in which the amount equivalent to the Bid Amount was blocked or the UPI ID (for UPI Bidders who make the payment of Bid Amount through the UPI Mechanism), date of Bid cum Application Form and the name and address of the relevant Designated Intermediary(ies) where the Bid was submitted. Further, the Bidder shall enclose the Acknowledgment Slip or the application number from the Designated Intermediaries in addition to the documents or information mentioned hereinabove. All grievances relating to Bids submitted through Registered Brokers may be addressed to the Stock Exchanges with a copy to the Registrar to the Offer. The Registrar to the Offer shall obtain the required information from the SCSBs for addressing any clarifications or grievances of ASBA Bidders.

All Offer-related grievances of the Anchor Investors may be addressed to Book Running Lead Managers, giving full details such as the name of the sole or First Bidder, Anchor Investor Application Form number, Bidders’ DP ID, Client ID, PAN, date of the Anchor Investor Application Form, address of the Bidder, number of the Equity Shares applied for, Bid Amount paid on submission of the Anchor Investor Application Form and the name and address of the BRLMs where the Anchor Investor Application Form was submitted by the Anchor Investor.

### **Book Running Lead Managers**

#### **Axis Capital Limited**

1<sup>st</sup> Floor, Axis House,  
C-2 Wadia International Centre  
PB Marg, Worli, Mumbai 400 025  
Maharashtra, India  
**Tel:** + 91 22 4325 2183  
**E-mail:** uil.ipo@axiscap.in  
**Website:** www.axiscapital.co.in  
**Investor grievance e-mail:** complaints@axiscap.in  
**Contact person:** Ankit Bhatia/Pratik Pednekar  
**SEBI registration no.:** INM000012029

#### **DAM Capital Advisors Limited**

*(Formerly IDFC Securities Limited)*  
One BKC, Tower C, 15<sup>th</sup> Floor  
Unit no. 1511, Bandra Kurla Complex  
Bandra (East), Mumbai 400 051  
Maharashtra, India  
**Tel:** +91 22 4202 2500  
**E-mail:** uniparts.ipo@damcapital.in  
**Investor grievance e-mail:**  
complaint@damcapital.in  
**Website:** www.damcapital.in  
**Contact person:** Chandresh Sharma  
**SEBI registration no.:** MB/INM000011336

#### **JM Financial Limited**

7<sup>th</sup> Floor, Cnergy  
Appasaheb Marathe Marg  
Prabhadevi, Mumbai 400 025

Maharashtra, India  
**Tel:** +91 22 6630 3030/ +91 22 6630 3262  
**E-mail:** uniparts.ipo@jmfl.com  
**Website:** grievance.ibd@jmfl.com  
**Investor grievance e-mail:** www.jmfl.com  
**Contact person:** Prachee Dhuri  
**SEBI registration no.:** NM000010361

### Statement of inter-se allocation of responsibilities among the Book Running Lead Managers

The responsibilities and co-ordination by the BRLMs for various activities in this Offer are as follows:

S. No.	Activity	Responsibility	Co-ordination
1.	Capital structuring, positioning strategy and due diligence of the Company including its operations/management/business plans/legal etc. Drafting and design of the Draft Red Herring Prospectus, Red Herring Prospectus, Prospectus, abridged prospectus and application form. The BRLMs shall ensure compliance with stipulated requirements and completion of prescribed formalities with the Stock Exchanges, RoC and SEBI including finalization of Prospectus and RoC filing	Axis, JM, DAM Capital	Axis
2.	Drafting and approval of statutory advertisements	Axis, JM, DAM Capital	Axis
3.	Drafting and approval of all publicity material other than statutory advertisement as mentioned above including corporate advertising, brochure, etc. and filing of media compliance report.	Axis, JM, DAM Capital	JM
4.	Appointment of intermediaries - Printers and Advertising Agency, including coordination of all agreements to be entered into with such intermediaries	Axis, JM, DAM Capital	Axis
5.	Appointment of intermediaries - Registrars, Sponsor Bank, Bankers to the Issue and other intermediaries, including coordination of all agreements to be entered into with such intermediaries	Axis, JM, DAM Capital	DAM Capital
6.	Preparation of road show marketing presentation and frequently asked questions	Axis, JM, DAM Capital	JM
7.	International Institutional marketing of the Offer, which will cover, inter alia: <ul style="list-style-type: none"> <li>• Institutional marketing strategy;</li> <li>• Finalizing the list and division of international investors for one-to-one meetings; and</li> <li>• Finalizing international road show and investor meeting schedule</li> </ul>	Axis, JM, DAM Capital	JM
8.	Domestic Institutional marketing of the Offer, which will cover, inter alia: <ul style="list-style-type: none"> <li>• Institutional marketing strategy;</li> <li>• Finalizing the list and division of domestic investors for one-to-one meetings; and</li> <li>• Finalizing domestic road show and investor meeting schedule</li> </ul>	Axis, JM, DAM Capital	Axis
9.	Retail marketing of the Offer, which will cover, inter alia: <ul style="list-style-type: none"> <li>• Formulating marketing strategies, preparation of publicity budget;</li> <li>• Finalizing media, marketing and public relations strategy;</li> <li>• Finalizing centres for holding conferences for brokers, etc.;</li> <li>• Finalizing collection centres;</li> <li>• Arranging for selection of underwriters and underwriting agreement; and</li> <li>• Follow-up on distribution of publicity and offer material including form, Prospectus and deciding on the quantum of the offer material</li> </ul>	Axis, JM, DAM Capital	DAM Capital
10.	Non-Institutional marketing of the Offer, which will cover, inter alia: <ul style="list-style-type: none"> <li>• Finalizing media, marketing and public relations strategy; and</li> <li>• Finalizing centres for holding conferences for brokers, etc.</li> </ul>	Axis, JM, DAM Capital	JM
11.	Managing the book and finalization of pricing in consultation with the Company and the Selling Shareholders and payment of 1% security deposit to the designated stock exchange.	Axis, JM, DAM Capital	JM
12.	Coordination with Stock-Exchanges for book building software, bidding terminals and mock trading; anchor co-ordination and intimation of anchor allocation.	Axis, JM, DAM Capital	DAM Capital

S. No.	Activity	Responsibility	Co-ordination
13.	Post- Issue activities, which shall involve essential follow-up with bankers to the Issue and SCSBs to get quick estimates of collection and advising our Company about the closure of the Issue, based on correct figures, finalization of the basis of allotment or weeding out of multiple applications, listing of instruments, dispatch of certificates or demat credit and refunds, payment of STT on behalf of the Selling Shareholders and coordination with various agencies connected with the post-Issue activity such as Registrar to the Issue, Bankers to the Issue, SCSBs including responsibility for underwriting arrangements, as applicable and submission of all post Offer reports including the final post Offer report to SEBI, co-ordination with designated exchange and SEBI for release of 1% security deposit.	Axis, JM, DAM Capital	DAM Capital

### Syndicate Members

[•]

### Legal Counsel to the Company and the Promoter Group Selling Shareholders as to Indian Law

#### Shardul Amarchand Mangaldas & Co

Amarchand Towers  
216, Okhla Industrial Estate Phase III  
New Delhi 110 020, India  
Tel: +91 11 4159 0700

### Legal Counsel to the Book Running Lead Managers as to Indian Law

#### AZB & Partners

AZB House  
Plot No. A-8, Sector-4  
Noida 201 301  
National Capital Region, Delhi  
Tel: +91 120 417 9999

#### AZB & Partners

AZB House,  
Peninsula Corporate Park  
Ganpatrao Kadam Marg  
Lower Parel  
Mumbai 400 013, India  
Tel: +91 22 6639 6880

### International Legal Counsel to the Book Running Lead Managers

#### Hogan Lovells Lee & Lee

50 Collyer Quay  
#10-01 OUE Bayfront  
Singapore 049321  
Tel: +65 6538 0900

### Legal Counsel to the Investor Selling Shareholders

#### Khaitan & Co

10<sup>th</sup> & 13<sup>th</sup> Floors, Tower 1C  
One World Centre  
841, Senapati Bapat Marg  
Mumbai 400 013  
Maharashtra, India  
Tel: +91 22 6636 5000

### Legal Counsel to the Individual Selling Shareholders

#### Rajani Associates, Solicitors

Krishna Chambers  
59 New Marine Lines  
Mumbai 400020  
Maharashtra, India

**Tel:** +91 22 4096 1000

**Registrar to the Offer**

**Link Intime India Private Limited**

C-101, 1<sup>st</sup> Floor,  
247 Park, L.B.S. Marg,  
Vikhroli West, Mumbai 400 083,  
Maharashtra, India

**Tel:** + 91 22 4918 6200

**E-mail:** uniparts.ipo@linkintime.co.in

**Investor grievance e-mail:** uniparts.ipo@linkintime.co.in

**Website:** www.linkintime.co.in

**Contact person:** Shanti Gopalkrishnan

**SEBI registration number:** INR000004058

**CIN:** U67190MH1999PTC118368

**Escrow Collection Bank(s)**

[•]

**Public Offer Account Bank**

[•]

**Refund Bank**

[•]

**Sponsor Banks**

[•]

**Bankers to our Company**

**DBS Bank India Limited**

Ground Floor No 11 and 12  
Capital Point BKS Park, Cannought Place  
New Delhi 110 001

**Contact person:** Vikram Gupta

**Website:** www.dbsbank.com

**Tel:** 91 11 6621 1888

**Email:** vikramg@dbsbank.com

**CIN:** U65999DL2018FLC329236

**RBL Bank Limited**

Upper Ground Floor, Hansalaya Building  
15, Barakhamba Road  
New Delhi 110 001

**Contact person:** Abhishek Gupta

**Website:** www.rblbank.com

**Tel:** 011 4936 5500

**Email:** abhishek.gupta@rblbank.com

**CIN:** L65191PN1943PLC007308

**Self Certified Syndicate Banks**

The list of SCSBs notified by SEBI for the ASBA process is available at <http://www.sebi.gov.in/sebiweb/other/OtherAction.do?doRecognised=yes>, or at such other website as may be prescribed by SEBI from time to time. A list of the Designated SCSB Branches with which an ASBA Bidder(other

than a Retail Individual Investor using the UPI Mechanism), not Bidding through Syndicate/Sub Syndicate or through a Registered Broker, RTA or CDP may submit the Bid cum Application Forms, is available at <https://www.sebi.gov.in/sebiweb/other/OtherAction.do?doRecognisedFpi=yes&intmId=34>, or at such other websites as may be prescribed by SEBI from time to time.

### **SCSBs and mobile applications enabled for UPI Mechanism**

In accordance with SEBI circular no. SEBI/HO/CFD/DIL2/CIR/P/2019/76 dated June 28, 2019 and SEBI circular no. SEBI/HO/CFD/DIL2/CIR/P/2019/85 dated July 26, 2019, UPI Bidders using the UPI Mechanism may only apply through the SCSBs and mobile applications using the UPI handles and whose names appear on the website of the SEBI, which may be updated from time to time. A list of SCSBs and mobile applications, which are live for applying in public issues using UPI mechanism, is provided as 'Annexure A' for SEBI circular number SEBI/HO/CFD/DIL2/CIR/P/2019/85 dated July 26, 2019 and is also available on <https://www.sebi.gov.in/sebiweb/other/OtherAction.do?doRecognisedFpi=yes&intmId=35> for SCSBs and <https://www.sebi.gov.in/sebiweb/other/OtherAction.do?doRecognisedFpi=yes&intmId=43> for mobile applications or at such other websites as may be prescribed by SEBI from time to time.

### **Syndicate SCSB Branches**

In relation to Bids (other than Bids by Anchor Investors) submitted under the ASBA process to a member of the Syndicate, the list of branches of the SCSBs at the Specified Locations named by the respective SCSBs to receive deposits of Bid cum Application Forms from the members of the Syndicate is available on the website of the SEBI (<https://www.sebi.gov.in/sebiweb/other/OtherAction.do?doRecognisedFpi=yes&intmId=35>) and updated from time to time or any other website prescribed by SEBI from time to time. For more information on such branches collecting Bid cum Application Forms from the Syndicate at Specified Locations, see the website of the SEBI <https://www.sebi.gov.in/sebiweb/other/OtherAction.do?doRecognisedFpi=yes&intmId=35> as updated from time to time or any other website prescribed by SEBI from time to time.

### **Broker Centres/ Designated CDP Locations/ Designated RTA Locations**

In accordance with SEBI Circular No. CIR/CFD/14/2012 dated October 4, 2012 and CIR/CFD/POLICYCELL/11/2015 dated November 10, 2015, Bidders (other than Anchor Investors) can submit Bid cum Application Forms with the Registered Brokers at the Broker Centres, CDPs at the Designated CDP Locations or the RTAs at the Designated RTA Locations, respective lists of which, including details such as address and telephone number, are available at the websites of the Stock Exchanges at [www.bseindia.com](http://www.bseindia.com) and [www.nseindia.com](http://www.nseindia.com) and at the website of SEBI at <https://www.sebi.gov.in/sebiweb/other/OtherAction.do?doRecognisedFpi=yes&intmId=34>. The list comprising the details of branches of the SCSBs at the Broker Centres, named by the respective SCSBs to receive deposits of the Bid cum Application Forms from the Registered Brokers will be available on the website of the SEBI at <https://www.sebi.gov.in/sebiweb/other/OtherAction.do?doRecognisedFpi=yes&intmId=34> and updated from time to time.

### **Statutory Auditors of our Company**

#### **Rakesh Banwari & Co.**

#### **Chartered Accountants**

10/52, 2<sup>nd</sup> Floor, Subash Nagar

New Delhi 110027

India

**Tel:** +91 11 4502 4859

**E-mail:** rbandco@hotmail.com

**Firm registration number:** 009732N

**Peer review number:** 011320

**Membership number:** 088193

### **Changes in Auditors**

There have been no changes to our statutory auditors in the last three years.

### **Expert**

Except as stated below, our Company has not obtained any expert opinions:

Our Company has received written consent dated April 25, 2022 from the Statutory Auditors, to include their name as required under section 26(5) of the Companies Act, 2013 read with SEBI ICDR Regulations, in this Draft Red Herring Prospectus, and as an “expert” as defined under section 2(38) of the Companies Act, 2013 and in respect of (i) their examination report dated March 22, 2022 on our Restated Financial Statements; and (ii) their report dated April 25, 2022 on the Statement of Possible Special Tax Benefits in this Draft Red Herring Prospectus. However, the term “expert” shall not be construed to mean an “expert” as defined under the U.S. Securities Act.

Our Company has received written consent dated March 2, 2022, from the chartered engineer, namely D.V. Mehta, to include their name in this Draft Red Herring Prospectus and as an “expert” as defined under Section 2(38) of the Companies Act, 2013.

Our Company has received written consents dated (i) March 2, 2022, from an independent architect, namely ADI Designs Private Limited, (ii) March 7, 2022 from an independent architect, namely M/S Nirmaan Architects; (iii) March 3, 2022, from an independent architect, namely, Architects Bureau, to include their names in this Draft Red Herring Prospectus and as “experts” as defined under Section 2(38) of the Companies Act, 2013.

The above-mentioned consents have not been withdrawn as on the date of this Draft Red Herring Prospectus.

### **Monitoring Agency**

As the Offer is through an Offer for Sale of Equity Shares, our Company is not required to appoint a monitoring agency for this Offer.

### **Grading of the Offer**

No credit agency registered with SEBI has been appointed for grading for the Offer.

### **Appraising Entity**

None of the objects for which the Net Proceeds will be utilised have been appraised by any agency.

### **Credit Rating**

As the Offer is of Equity Shares, credit rating is not required.

### **Green Shoe Option**

No green shoe option is contemplated under the Offer.

### **Filing of this Draft Red Herring Prospectus**

A copy of this Draft Red Herring Prospectus has been filed electronically on the SEBI’s online portal and at [cfddil@sebi.gov.in](mailto:cfddil@sebi.gov.in), in accordance with the instructions issued by the SEBI on March 27, 2020, in relation to “*Easing of Operational Procedure – Division of Issues and Listing – CFD*”, and will be filed with SEBI’s electronic platform at: <https://siportal.sebi.gov.in/intermediary/index.html>, in accordance with SEBI circular bearing reference SEBI/HO/CFD/DIL1/CIR/P/2018/011 dated January 19, 2018 and Regulation 25(8) of the SEBI ICDR Regulations. It will also be filed with the Securities and Exchange Board of India at:

### **Securities and Exchange Board of India**

Corporation Finance Department  
Division of Issues and Listing  
SEBI Bhavan, Plot No. C4 A, ‘G’ Block  
Bandra Kurla Complex  
Bandra (E)  
Mumbai 400 051, Maharashtra, India

A copy of the Red Herring Prospectus, along with the material documents and contracts required to be filed, shall be filed with the RoC in accordance with Section 32 of the Companies Act and a copy of the Prospectus required

to be filed under Section 26 of the Companies Act, shall be filed with the RoC at its office located at 4<sup>th</sup> Floor, IFCI Tower, 61, Nehru Place, New Delhi 110 019, India and through the electronic portal at <https://www.mca.gov.in/mcafoportal/login.do>.

### **Book Building Process**

Book building, in the context of the Offer, refers to the process of collection of Bids from Bidder on the basis of the Red Herring Prospectus, the Bid cum Application Forms and the Revision Forms within the Price Band and minimum Bid lot which will be decided by our Company and the Investor Selling Shareholders, in consultation with the BRLMs and advertised in [●] editions of [●] (a widely circulated English national daily newspaper), [●] editions of [●] (a widely circulated Hindi national daily newspaper, Hindi also being the regional language of New Delhi, where our Registered Office is located) each with wide circulation, at least two Working Days prior to the Bid/Offer Opening Date and shall be made available to the Stock Exchanges for the purposes of uploading on their respective website. The Offer Price shall be determined by our Company and the Investor Selling Shareholders, in consultation with the BRLMs after the Bid/Offer Closing Date. For further details, see “*Offer Procedure*” on page 417.

**All investors, other than Anchor Investors, shall only participate through the ASBA process by providing the details of their respective ASBA Account in which the corresponding Bid Amount will be blocked by the SCSBs or, in the case of UPI Bidders, by using the UPI Mechanism. Anchor Investors are not permitted to participate in the Offer through the ASBA process.**

**In terms of the SEBI ICDR Regulations, QIBs and Non-Institutional Investors are not permitted to withdraw their Bid(s) or lower the size of their Bid(s) (in terms of quantity of Equity Shares or the Bid Amount) at any stage. Retail Individual Investors can revise their Bid(s) during the Bid/Offer Period and withdraw their Bid(s) until Bid/Offer Closing Date. Anchor Investors are not allowed to revise and withdraw their Bids after the Anchor Investor Bidding Date. Except Allocation to Retail Individual Investors, Non-Institutional Investors and the Anchor Investors, Allocation in the Offer will be on a proportionate basis. Allocation to the Anchor Investors will be on a discretionary basis.**

For further details on method and process of Bidding, see “*Offer Procedure*” and “*Offer Structure*” on page 417 and 414 respectively.

**Our Company will comply with the SEBI ICDR Regulations and any other directions issued by SEBI in relation to this Offer. Each of the Selling Shareholders have, severally and not jointly, specifically confirmed that they will comply with the SEBI ICDR Regulations and any other directions issued by SEBI, as applicable to such Selling Shareholder, in relation to its portion of the Offered Shares. In this regard, our Company and the Selling Shareholders have appointed the Book Running Lead Managers to manage this Offer and procure Bids for this Offer.**

**The Book Building Process and the bidding process are subject to change, from time to time. Bidders are advised to make their own judgment about an investment through this process prior to submitting a Bid in the Offer.**

Investors should note the Offer is also subject to obtaining: (i) final listing and trading approvals of the Stock Exchanges, which our Company shall apply for after Allotment; and (ii) the final approval of the RoC after the Prospectus is filed with the RoC.

Each Bidder, by submitting a Bid in the Offer, will be deemed to have acknowledged the above restrictions and the terms of the Offer.

### **Explanation of Book Building Process and Price Discovery Process**

For an explanation of the Book Building Process and the price discovery process, see “*Terms of the Offer*” and “*Offer Procedure*” on pages 408 and 417, respectively.

### **Underwriting Agreement**

After the determination of the Offer Price and allocation of Equity Shares but prior to the filing of the Prospectus with the RoC, our Company and the Selling Shareholders intend to enter into an Underwriting Agreement with the Underwriters for the Equity Shares proposed to be offered through the Offer. The extent of underwriting

obligations and the Bids to be underwritten by each BRLM shall be as per the Underwriting Agreement. Pursuant to the terms of the Underwriting Agreement, the obligations of the Underwriters will be several and will be subject to certain conditions to closing, as specified therein.

The Underwriting Agreement is dated [●]. The Underwriters have indicated their intention to underwrite the following number of Equity Shares:

<i>(in ₹ million)</i>		
Name, address, telephone and e-mail of the Underwriters	Indicative number of Equity Shares to be underwritten	Amount underwritten
[●]	[●]	[●]
[●]	[●]	[●]

The abovementioned amounts are provided for indicative purposes only and would be finalized after the pricing and actual allocation and subject to the provisions of the SEBI ICDR Regulations.

In the opinion of our Board of Directors (based on representations made to our Company by the Underwriters), the resources of the Underwriters are sufficient to enable them to discharge their respective underwriting obligations in full. The Underwriters are registered as merchant bankers with SEBI or registered as brokers with the Stock Exchange(s). Our Board of Directors, at its meeting held on [●], has accepted and entered into the Underwriting Agreement mentioned above on behalf of our Company. Allocation among the Underwriters may not necessarily be in proportion to their underwriting commitments set forth in the table above.

Notwithstanding the above table, the Underwriters shall be severally responsible for ensuring payment with respect to Equity Shares allocated to investors procured by them. In the event of any default in payment, the respective Underwriter, in addition to other obligations defined in the Underwriting Agreement, will also be required to procure subscriptions for/subscribe to Equity Shares to the extent of the defaulted amount in accordance with the Underwriting Agreement.

The Underwriting Agreement has not been executed as on the date of this Draft Red Herring Prospectus and our Company and the Selling Shareholders intend to enter into an Underwriting Agreement with the Underwriters after the determination of the Offer Price and allocation of Equity Shares, but prior to filing the Prospectus with the RoC.



## CAPITAL STRUCTURE

The share capital of our Company, as of the date of this Draft Red Herring Prospectus, is set forth below.

<i>(in ₹, except share data or as stated otherwise)</i>			
		Aggregate value at face value	Aggregate value at Offer Price*
<b>A AUTHORISED SHARE CAPITAL<sup>(1)</sup></b>			
60,000,000 Equity Shares of face value ₹ 10 each		600,000,000	
<b>B ISSUED, SUBSCRIBED AND PAID-UP SHARE CAPITAL BEFORE THE OFFER</b>			
45,133,758 Equity Shares of face value ₹ 10 each		451,337,580	[●]
<b>C PRESENT OFFER IN TERMS OF THIS DRAFT RED HERRING PROSPECTUS</b>			
Offer for Sale of up to 15,731,942 Equity Shares <sup>(2)(3)</sup>		157,319,420	Up to ₹ [●] million
<b>D ISSUED, SUBSCRIBED AND PAID-UP SHARE CAPITAL AFTER THE OFFER</b>			
45,133,758 Equity Shares		451,337,580	[●]
<b>E SECURITIES PREMIUM ACCOUNT</b>			
Before <i>(as on date of this Draft Red Herring Prospectus)</i> and after the Offer			₹ 789.74 million

\* To be updated upon finalisation of Offer Price.

<sup>(1)</sup> For details in relation to the changes in the authorised share capital of our Company, see “*History and Certain Corporate Matters – Amendments to our Memorandum of Association in the last 10 years*” on page 180.

<sup>(2)</sup> The Offer has been authorised by our Board of Directors pursuant to the resolution passed at their meeting dated March 30, 2022. Further, our Board has taken on record the approval for the Offer for Sale by the Selling Shareholders pursuant to its resolution dated April 25, 2022. The Selling Shareholders have confirmed and authorised their participation in the Offer for Sale. For further details, see “*Other Regulatory and Statutory Disclosures*” on page 395.

<sup>(3)</sup> The Equity Shares being offered by the Selling Shareholders have been held by the Selling Shareholders for a period of at least one year prior to the date of filing of this Draft Red Herring Prospectus in accordance with Regulation 8 of the SEBI ICDR Regulations and accordingly, are eligible for the Offer in accordance with the provisions of the SEBI ICDR Regulations. For details of authorisations for the Offer for Sale, see “*Other Regulatory and Statutory Disclosures*” on page 395.

### Notes to Capital Structure

#### (i) Share Capital History

##### 1. History of Equity Share capital of our Company

The following table sets forth the history of the Equity Share capital of our Company:

Date of Allotment	Name(s) of allottee(s)	Nature of Allotment	No. of Equity Shares Allotted	Face Value (₹)	Issue price per Equity Share (₹)	Form of consideration
October 3, 1994	10 Equity Shares each to Kirpal Singh, Gurdeep Soni, Paramjit Singh Soni, Harjit K. Singh, Pamela Soni, Sarabjit Soni and Joginder S. Chatha	Initial subscription of the Memorandum of Association	70	10	10.00	Cash
December 14, 1998	90 Equity Shares to Soni	Paramjit Singh Preferential allotment	90	10	10.00	Cash
March 28, 2000	1,990 Equity Shares to Harjit K. Singh, 19,590 Equity Shares to Kirpal Singh, 19,590 Equity Shares to Gurdeep Soni, 19,590 Equity Shares to Sarabjit Soni, 19,500 Equity Shares to Paramjit Singh Soni and 19,490 Equity Shares to Pamela Soni	Preferential allotment	99,750	10	10.00	Cash
March 31, 2005	3,217,500 Equity Shares to Gurdeep Soni, 3,217,500 Equity Shares to Paramjit Singh Soni, 466,090 Equity Shares to Pamela Soni, 466,000 Equity	Preferential allotment	7,992,990	10	10.00	Cash

Date of Allotment	Name(s) of allottee(s)	Nature of Allotment	No. of Equity Shares Allotted	Face Value (₹)	Issue price per Equity Share (₹)	Form of consideration
	Shares to Sarabjit Soni 385,100 Equity Shares to Kirpal Singh and 240,800 Equity Shares to Harjit K. Singh					
February 2, 2007	1,294,840 Equity Shares to Gurdeep Soni, 1,294,840 Equity Shares to Paramjit Singh Soni, 194,240 Equity Shares to Sarabjit Soni, 194,236 Equity Shares to Pamela Soni, 161,880 Equity Shares to Kirpal Singh, 97,120 Equity Shares to Harjit K. Singh, and 4 Equity Shares to Angad Soni	Bonus issue in the ratio of two Equity Shares for every five Equity Shares held by existing Shareholders	3,237,160	10	-	N.A.
February 2, 2007	Uniparts ESOP Trust	Preferential allotment	350,400	10	135.00	Cash
June 12, 2007	59,126 Equity Shares to Andrew Warren Code, 59,126 Equity Shares to James Norman Hallene, 59,126 Equity Shares to Kevin John Code, 19,140 Equity Shares to Dennis Francis DeDecker, 13,910 Equity Shares to Melvin Keith Gibbs, 10,435 Equity Shares to Mark Louis Dawson, 8,235 Equity Shares to Walter James Gruber, 7,185 Equity Shares to Wendy Reichard Hammen, 5,455 Equity Shares to Bradley Lorenz Miller, 3,480 Equity Shares to Mary Louise Arp, 2,780 Equity Shares to Diana Lynn Craig, 2,570 Equity Shares to Marc Christopher Dorau, 1,670 Equity Shares to Craig A. Johnson and 275 Equity Shares to Misty Marie Garcia	Preferential allotment	252,513	10	294.71	Cash
September 25, 2007	1,957,331 Equity Shares to Ashoka and 587,199 Equity Shares to Ambadevi	Preferential allotment	2,544,530	10	294.75	Cash
March 27, 2009	436,216 Equity Shares to Ashoka and 130,865 Equity Shares to Ambadevi	Preferential allotment	567,081	10	10.00	Cash
August 4, 2009	2,492,595 Equity Shares to Gurdeep Soni, 2,492,595 Equity Shares to Paramjit Singh Soni, 1,196,774 Equity Shares to Ashoka, 359,032 Equity Shares to Ambadevi, 339,920 Equity Shares to Sarabjit Soni, 309,934 Equity Shares to Pamela Soni, 175,200 Equity Shares to Uniparts ESOP Trust, 29,563 Equity Shares to Andrew Warren Code, 29,563 Equity Shares to James Norman Hallene, 29,563 Equity Shares to Kevin John Code, 24,986 Equity Shares to Angad Soni, 9,570 Equity Shares to Dennis Francis DeDecker, 6,955 Equity Shares to Melvin Keith Gibbs, 5,218 Equity Shares to Rini Kalra, 5,000 Equity Shares to Arjun Soni, 4,118 Equity Shares to Walter James Gruber, 3,593 Equity Shares to Wendy Reichard Hammen, 2,728 Equity Shares to Bradley Lorenz Miller, 1,740 Equity	Rights issue of one Equity Share for every two existing Equity Shares held as on the record date being July 4, 2009	7,522,295	10	45.00	Cash

Date of Allotment	Name(s) of allottee(s)	Nature of Allotment	No. of Equity Shares Allotted	Face Value (₹)	Issue price per Equity Share (₹)	Form of consideration
	Shares to Mary Louise Arp, 1,390 Equity Shares to Diana Lynn Craig, 1,285 Equity Shares to Marc Christopher Dorau, 835 Equity Shares to Craig A. Johnson and 138 Equity Shares to Misty Marie Garcia.					
April 4, 2014	7,477,785 Equity Shares to Gurdeep Soni, 3,590,321 Equity Shares to Ashoka, 3,297,545 Equity Shares to Paramjit Singh Soni, 2,600,000 Equity Shares to Meher Soni, 2,600,000 Equity Shares to Karan Soni, 1,077,096 Equity Shares to Ambadevi, 989,760 Equity Shares to Pamela Soni, 525,600 Equity Shares to Uniparts ESOP Trust, 25,000 Equity Shares to Angad Soni, 88,689 Equity Shares to Andrew Warren Code, 88,689 Equity Shares to James Norman Hallene, 88,689 Equity Shares to Kevin John Code, 28,710 Equity Shares to Dennis Francis DeDecker, 20,865 Equity Shares to Melvin Keith Gibbs, 12,353 Equity Shares to Walter James Gruber, 10,778 Equity Shares to Wendy Reichard Hammen, 10,435 Equity Shares to Mark Louis Dawson, 8,183 Equity Shares to Bradley Lorenz Miller, 5,220 Equity Shares to Mary Louise Arp, 5,218 Equity Shares to Rini Kalra, 5,000 Equity Shares to Arjun Soni, 4,170 Equity Shares to Diana Lynn Craig, 3,855 Equity Shares to Marc Christopher Dorau, 2,505 Equity Shares to Craig A. Johnson and 413 Equity Shares to Misty Marie Garcia.	Bonus issue in the ratio of one Equity Share for every Equity Share held by the existing Shareholders.	22,566,879	10	-	N.A.

**2. Issue of Equity Shares issued through bonus or for consideration other than cash or out of revaluation reserves**

Details of Equity Shares issued pursuant to bonus issue are as follows:

Date of allotment	Names of the allottees	Number of Equity Shares allotted	Face value per Equity Share (₹)	Issue price per Equity Share (₹)	Nature of consideration	Reason/ Nature of allotment
February 2, 2007	1,294,840 Equity Shares to Gurdeep Soni, 1,294,840 Equity Shares to Paramjit Singh Soni, 194,240 Equity Shares to Sarabjit Soni, 194,236 Equity Shares to Pamela Soni, 161,880 Equity Shares to Kirpal Singh, 97,120 Equity Shares to Harjit K. Singh, and 4 Equity Shares to Angad Soni	3,237,160	10	-	N.A.	Bonus issue in the ratio of two Equity Shares for every five Equity Shares held by existing Shareholders

Date of allotment	Names of the allottees	Number of Equity Shares allotted	Face value per Equity Share (₹)	Issue price per Equity Share (₹)	Nature of consideration	Reason/ Nature of allotment
April 4, 2014	Existing shareholders of the Company <sup>(1)</sup>	22,566,879	10	-	N.A.	Bonus issue in the ratio of one Equity Shares for every Equity Share held by the existing Shareholders

<sup>(1)</sup> 7,477,785 Equity Shares to Gurdeep Soni, 3,590,321 Equity Shares to Ashoka, 3,297,545 Equity Shares to Paramjit Singh Soni, 2,600,000 Equity Shares to Meher Soni, 2,600,000 Equity Shares to Karan Soni, 1,077,096 Equity Shares to Ambadevi, 989,760 Equity Shares to Pamela Soni, 525,600 Equity Shares to Uniparts ESOP Trust, 25,000 Equity Shares to Angad Soni, 88,689 Equity Shares to Andrew Warren Code, 88,689 Equity Shares to James Norman Hallene, 88,689 Equity Shares to Kevin John Code, 28,710 Equity Shares to Dennis Francis DeDecker, 20,865 Equity Shares to Melvin Keith Gibbs, 12,353 Equity Shares to Walter James Gruber, 10,778 Equity Shares to Wendy Reichard Hammen, 10,435 Equity Shares to Mark Louis Dawson, 8,183 Equity Shares to Bradley Lorenz Miller, 5,220 Equity Shares to Mary Louise Arp, 5,218 Equity Shares to Rini Kalra, 5,000 Equity Shares to Arjun Soni, 4,170 Equity Shares to Diana Lynn Craig, 3,855 Equity Shares to Marc Christopher Dorau, 2,505 Equity Shares to Craig A. Johnson and 413 Equity Shares to Misty Marie Garcia.

Our Company has not issued any Equity Shares for consideration other than cash. Further, our Company has not issued any shares out of revaluation reserves, since its incorporation.

### 3. Issue of Equity Shares pursuant to schemes of arrangement

Our Company has not allotted any Equity Shares pursuant to any scheme of arrangement approved under Sections 230-234 of the Companies Act, 2013, as applicable.

### 4. Issue of Equity Shares at a price lower than the Offer Price in the last year

Our Company has not issued any Equity Shares at a price that may be lower than the Offer Price during the period of one year preceding the date of this Draft Red Herring Prospectus.

### 5. Issue of Equity Shares under employee stock option schemes

Other than Equity Shares issued to the Uniparts ESOP Trust as disclosed in “– *History of Equity Share Capital of our Company*” our Company has not issued any Equity Shares under the employee stock option scheme as on date of this Draft Red Herring Prospectus.

### 6. History of build-up of Promoters’ shareholding and lock-in of Promoters’ shareholding (including Promoters’ contribution)

As on the date of this Draft Red Herring Prospectus, our Promoters hold, in aggregate, 9,195,090 Equity Shares, which constitute 20.37% of the issued, subscribed and paid-up Equity Share capital of our Company. All the Equity Shares held by our Promoters are held in dematerialised form.

#### (i) Build-up of Promoter’s shareholding in our Company

Set forth below is the build-up of our Promoter’s shareholding since the incorporation of our Company:

#### Equity share capital build-up of our Promoters

Date of allotment/ transfer	Number of equity shares allotted/ transferred	Face value per Equity Share (₹)	Issue/ acquisition/ transfer price per equity share (₹)	Nature of transaction	% of the pre- Offer Equity Share capital	% of the post-Offer share capital
<b>Gurdeep Soni</b>						
October 3, 1994	10	10	10	Initial subscription to the Memorandum of Association	Negligible	Negligible
March 28, 2000	19,590	10	10	Preferential allotment	0.04	0.04

Date of allotment/transfer	Number of equity shares allotted/transferred	Face value per Equity Share (₹)	Issue/acquisition/transfer price per equity share (₹)	Nature of transaction	% of the pre- Offer Equity Share capital	% of the post-Offer share capital
March 31, 2005	3,217,500	10	10	Preferential allotment	7.13	7.13
February 2, 2007	1,294,840	10	-	Bonus issue in the ratio of two Equity Shares for every five Equity Shares held by the existing Shareholders	2.87	2.87
March 27, 2008*	169,960	10	NA	Transmission of Equity Shares from Late Harjit K. Singh	0.38	0.38
December 26, 2008	283,290	10	10	Transfer of Equity Shares at par from Kirpal Singh	0.63	0.63
August 4, 2009	2,492,595	10	45	Rights issue in the ratio of one Equity share for every two Equity Shares	5.52	5.52
April 4, 2014	7,477,785	10	-	Bonus issue in the ratio of one Equity Shares for each Equity Share	16.57	16.57
January 8, 2021	(1,020,480)	10	NA	Gift of 1,020,480 Equity Shares by Gurdeep Soni to Pamela Soni	(2.26)	(2.26)
January 8, 2021	(1,950,000)	10	NA	Gift of 1,950,000 Equity Shares by Gurdeep Soni to Angad Soni	(4.32)	(4.32)
January 8, 2021	(1,990,000)	10	NA	Gift of 1,990,000 Equity Shares by Gurdeep Soni to Arjun Soni	(4.41)	(4.41)
January 8, 2021	(1,000,000)	10	NA	Gift of 1,000,000 Equity Shares by Gurdeep Soni to Tanya Kohli	(2.22)	(2.22)
<b>Total (A)</b>	<b>8,995,090</b>				<b>19.93</b>	<b>19.93</b>
<b>Paramjit Singh Soni</b>						
October 3, 1994	10	10	10	Initial subscription to the Memorandum of Association	Negligible	Negligible
December 14, 1998	90	10	10	Preferential allotment	Negligible	Negligible
March 28, 2000	19,500	10	10	Preferential allotment	Negligible	Negligible
March 31, 2005	3,217,500	10	10	Preferential allotment	7.13	7.13
February 2, 2007	1,294,840	10	-	Bonus issue in the ratio of two Equity Shares for every five Equity Shares held by the existing Shareholders	2.87	2.87
March 27, 2008*	169,960	10	N.A.	Transmission of Equity Shares from Late Harjit K. Singh to Paramjit Singh Soni	0.38	0.38
December 26, 2008	283,290	10	10	Transfer of Equity Shares from Kirpal Singh to Paramjit Singh Soni	0.63	0.63
August 4, 2009	2,492,595	10	45	Rights issue	5.52	5.52
December 24, 2012	(4,180,240)	10	N.A.	Gift of 1,580,240 Equity Shares from Paramjit Singh Soni to Meher Soni and gift of	(9.26)	(9.26)

Date of allotment/ transfer	Number of equity shares allotted/ transferred	Face value per Equity Share (₹)	Issue/ acquisition/ transfer price per equity share (₹)	Nature of transaction	% of the pre- Offer Equity Share capital	% of the post-Offer share capital
				2,600,000 Equity Shares from Paramjit Singh Soni to Karan Soni		
April 4, 2014	3,297,545	10	-	Bonus issue in the ratio of one Equity Shares for each Equity Share held by the existing Shareholders	7.31	7.31
January 16, 2019	(5,595,090)	10	NA	Gift of 5,595,090 Equity Shares by Paramjit Singh Soni to the Paramjit Soni 2018 CG-NG Nevada Trust	(12.40)	(12.40)
December 9, 2020	(800,000)	10	NA	Gift of 800,000 Equity Shares by Paramjit Singh Soni to the Paramjit Soni 2018 CG-NG Nevada Trust	(1.77)	(1.77)
<b>Total (B)</b>	<b>200,000</b>				<b>0.44</b>	<b>0.44</b>

\* While the transmission was noted by the Board at its meeting held on March 27, 2008, the transmission form is dated February 8, 2008.

All the Equity Shares held by our Promoters were fully paid-up on the respective date of allotment of such Equity Shares. As on the date of this Draft Red Herring Prospectus, none of the Equity Shares held by our Promoters are subject to any pledge.

(ii) **Shareholding of our Promoters and the members of our Promoter Group**

Set forth below is the equity shareholding of our Promoters and the members of the Promoter Group as on the date of this Draft Red Herring Prospectus:

Name of shareholder	Pre-Offer		Post-Offer*	
	No. of Equity Shares	% of pre-Offer Equity Share capital	No. of Equity Shares	% of post-Offer capital
<b>Promoters</b>				
Gurdeep Soni	8,995,090	19.93	8,995,090	19.93
Paramjit Singh Soni	200,000	0.44	200,000	0.44
<b>Sub-total (A)</b>	<b>9,195,090</b>	<b>20.37</b>	<b>9,195,090</b>	<b>20.37</b>
<b>Promoter Group</b>				
The Paramjit Soni 2018 CG-NG Nevada Trust	6,395,090	14.17	6,395,090	14.17
The Karan Soni 2018 CG-NG Nevada Trust	5,200,000	11.52	3,500,000	7.75
The Meher Soni 2018 CG-NG Nevada Trust	5,200,000	11.52	3,500,000	7.75
Pamela Soni	3,000,000	6.65	750,000	1.66
Angad Soni	2,000,000	4.43	2,000,000	4.43
Arjun Soni	2,000,000	4.43	2,000,000	4.43
Tanya Kohli	1,000,000	2.22	1,000,000	2.22
Jaswinder Singh Bhogal	102,948	0.23	102,948	0.23
<b>Sub-total (B)</b>	<b>24,898,038</b>	<b>55.17</b>	<b>19,248,038</b>	<b>42.65</b>
<b>Total (A+B)</b>	<b>34,093,128</b>	<b>75.54</b>	<b>28,443,128</b>	<b>63.02</b>

\* Subject to finalization of Basis of Allotment, and assuming transfer of all Offered Shares.

(iii) **Details of minimum Promoters' contribution locked in for 18 months or any other period as may be prescribed under applicable law**

Pursuant to Regulations 14 and 16 of the SEBI ICDR Regulations, an aggregate of 20% of the post-Offer Equity Share capital of our Company held by our Promoters shall be considered as minimum promoters' contribution and locked-in for a period of 18 months or any other period as may be prescribed under

applicable law, from the date of Allotment (“**Promoter’s Contribution**”). Our Promoter’s shareholding in excess of 20% of the fully diluted post-Offer Equity Share capital shall be locked in for a period of six months from the date of Allotment.

Our Promoters have given consent to include such number of Equity Shares held by them, in aggregate, as constituting 20% of the fully diluted post-Offer Equity Share capital of our Company as Promoter’s Contribution. Details of Promoters’ Contribution are as provided below:

Name of the Promoter	No. of Equity Shares held	No. of Equity Shares** locked-in	Date of allotment/ transfer#	Face value per Equity Share (₹)	Allotment/ Acquisition price per Equity Share (₹)	Nature of transaction	% of the fully diluted post-Offer paid-up Capital
Gurdeep Soni	[●]	[●]	[●]	[●]	[●]	[●]	[●]
Paramjit Singh Soni	[●]	[●]	[●]	[●]	[●]	[●]	[●]
<b>Total</b>	[●]	[●]	[●]	[●]	[●]	[●]	[●]

Note: To be updated at the Prospectus stage.

# Equity Shares were fully paid-up on the date of allotment/acquisition.

\*\* Subject to finalisation of Basis of Allotment.

The Equity Shares that are being locked-in for computation of Promoters’ Contribution are not and will not be ineligible under Regulation 15 of the SEBI ICDR Regulations. In particular:

- (i) these Equity Shares do not and shall not consist of Equity Shares acquired during the three years preceding the date of this Draft Red Herring Prospectus (a) for consideration other than cash and revaluation of assets or capitalisation of intangible assets, or (b) as a result of bonus shares issued by utilization of revaluation reserves or unrealised profits or from bonus issue against Equity Shares which are otherwise in-eligible for computation of Promoters’ Contribution;
  - (ii) these Equity Shares do not and shall not consist of Equity Shares acquired during the one year preceding the date of this Draft Red Herring Prospectus, at a price lower than the price at which the Equity Shares are being offered to the public in the Offer;
  - (iii) our Company has not been formed by the conversion of one or more partnership firms or a limited liability partnership firm; and
  - (iv) these Equity Shares do not and shall not consist of Equity Shares held by the Promoters that are subject to any pledge or any other form of encumbrance.
- (iv) **Details of share capital locked-in for six months or any other period as may be prescribed under applicable law**

In terms of the SEBI ICDR Regulations, except for:

1. the Promoters’ Contribution which shall be locked in as above;
2. the Equity Shares transferred to our employees from the Uniparts ESOP Trust under ESOP 2007 pursuant to exercise of options held by such employees (whether current employees or not and including the legal heirs or nominees of any deceased employees or ex-employees); and
3. the Equity Shares successfully transferred by the Selling Shareholders pursuant to the Offer for Sale;

the entire pre-Offer Equity Share capital of our Company (including those Equity Shares held by our Promoters in excess of Promoter’s Contribution), shall, unless otherwise permitted under the SEBI ICDR Regulations, be locked in for a period of six months from the date of Allotment in the Offer or any other period as may be prescribed under applicable law. In terms of Regulation 17(c) of the SEBI ICDR Regulations, Equity Shares held by a venture capital fund or alternative investment fund of category I or category II or a foreign venture capital investor (including Ashoka and Ambadevi, which are both foreign

venture capital investors registered with SEBI) shall not be locked-in for a period of six months from the date of Allotment.

In terms of Regulation 22 of the SEBI ICDR Regulations, Equity Shares held by our Promoters which are locked-in, may be transferred to Promoters or members of the Promoter Group or to any new Promoters, subject to continuation of lock-in in the hands of the transferees for the remaining period and compliance with provisions of the Takeover Regulations, as applicable and such transferee shall not be eligible to transfer them till the lock-in period stipulated in SEBI ICDR Regulations has expired. The Equity Shares held by persons other than our Promoters and locked-in for a period of six months from the date of Allotment in the Offer or any other period as may be prescribed under applicable law, may be transferred to any other person holding Equity Shares which are locked -in, subject to the continuation of the lock-in in the hands of the transferee for the remaining period and compliance with the provisions of the Takeover Regulations.

(v) ***Lock-in of Equity Shares Allotted to Anchor Investors***

50% of the Equity Shares Allotted to Anchor Investors in the Anchor Investor Portion shall be locked in for a period of 90 days from the date of Allotment and the remaining 50% of the Equity Shares Allotted to Anchor Investors in the Anchor Investor Portion shall be locked in for a period of 30 days from the date of Allotment.

(vi) ***Sales or purchases of Equity Shares or other specified securities of our Company by our Promoters, the members of our Promoter Group, and/or our Directors and their relatives during the six months immediately preceding the date of this Draft Red Herring Prospectus.***

None of our Promoters have sold or purchased any Equity Shares or other specified securities of our Company during the six months immediately preceding the date of this Draft Red Herring Prospectus. Further, except for 102,948 Equity Shares purchased by Jaswinder Singh Bhogal, none of the members of our Promoter Group, and/or our Directors and their relatives and relatives of our Promoters have sold or purchased any Equity Shares or other specified securities of our Company during the six months immediately preceding the date of this Draft Red Herring Prospectus.



## 7. Shareholding Pattern of our Company

a) The table below presents the shareholding pattern of our Company as on the date of this Draft Red Herring Prospectus.

Category (I)	Category of shareholder (II)	Number of shareholders (III) <sup>(1)</sup>	Number of fully paid up Equity Shares held (IV)	Number of Partly paid-up Equity Shares held (V)	Number of shares underlying Depository Receipts (VI)	Total number of shares held (VII) = (IV)+(V)+(VI)	Shareholding as a % of total number of shares (calculated as per SCRR, 1957) (VIII) As a % of (A+B+C2)	Number of Voting Rights held in each class of securities (IX)			Number of Equity shares Underlying Outstanding convertible securities (including Warrants) (X)	Shareholding, as a % assuming full conversion of convertible securities ( as a percentage of diluted share capital) (XI) = (VII)+(X) As a % of (A+B+C2)	Number of Locked in Equity Shares (XII)		Number of Equity Shares pledged or otherwise encumbered (XIII)		Number of Equity Shares held in dematerialized form (XIV)	
								Class eg: Equity Shares	Class eg: Others	Total			Number (a)	As a % of total Shares held (b)	Number (a)	As a % of total Shares held (b)		
																		Total as a % of (A+B+C)
(A)	Promoters and Promoter Group	10	34,093,128	-	-	34,093,128	75.54	34,093,128	-	34,093,128	75.54	-	75.54	-	-	-	-	34,093,128
(B)	Public	20	10,124,628	-	-	10,124,628	22.43	10,124,628	-	10,124,628	22.43	-	22.43	-	-	-	-	10,124,628
(C)	Non Promoter-Non Public																	
(C1)	Shares underlying DRs	-	-	-	-	-	-	-	-	-	-	-	-	-	-	-	-	-
(C2)	Shares held by Employee Trusts	1	916,002	-	-	916,002	2.03	916,002	-	916,002	2.03	-	2.03	-	-	-	-	916,002
	<b>Total</b>	31	45,133,758	-	-	45,133,758	100.00	45,133,758	-	45,133,758	100.00	-	100.00	-	-	-	-	45,133,758

b) As on the date of this Draft Red Herring Prospectus, our Company has 31 Shareholders.

### 8. Shareholding of Directors and Key Managerial Personnel in our Company

Except as stated below, none of our Directors or Key Managerial Personnel hold any Equity Shares in our Company:

S. No.	Shareholder	Number of Equity Shares	% of the pre- Offer Equity Share Capital	Number of employee stock options outstanding	% of the post- Offer Equity Share Capital
(i)	Gurdeep Soni	8,995,090	19.93	-	19.93
(ii)	Paramjit Singh Soni	200,000	0.44	-	0.44
(iii)	Herbert Coenen	-	-	451,336	-*
(iv)	Munish Sapra	-	-	29,912	-*
(v)	Sudhakar Kolli	-	-	100,000	-*
	<b>Total</b>	<b>9,195,090</b>	<b>20.37</b>	<b>581,248</b>	<b>20.37</b>

\* Assuming exercise of 517,336 of vested options. Of the options outstanding but not yet vested, the earliest vesting date is November 22, 2022.

### 9. Details of shareholding of the major Shareholders of our Company

The Shareholders holding 1% or more of the equity paid-up capital of our Company as on the date of filing of this Draft Red Herring Prospectus is as follows:

S. No.	Name of the Shareholder	Number of Equity Shares	Percentage of Equity Share capital (%)
1.	Gurdeep Soni	8,995,090	19.93
2.	Ashoka Investment Holdings Limited	7,180,642	15.91
3.	The Paramjit Soni 2018 CG-NG Nevada Trust	6,395,090	14.17
4.	The Karan Soni 2018 CG-NG Nevada Trust	5,200,000	11.52
5.	The Meher Soni 2018 CG-NG Nevada Trust	5,200,000	11.52
6.	Pamela Soni	3,000,000	6.65
7.	Ambadevi Mauritius Holding Limited	2,154,192	4.77
8.	Angad Soni	2,000,000	4.43
9.	Arjun Soni	2,000,000	4.43
10.	Tanya Kohli	1,000,000	2.22
11.	Uniparts ESOP Trust	916,002	2.03
	<b>Total</b>	<b>44,041,016</b>	<b>97.58</b>

The Shareholders holding 1% or more of the equity paid-up capital of our Company ten days prior to the filing of this Draft Red Herring Prospectus is as follows:

S. No.	Name of the Shareholder	Number of Equity Shares	Percentage of pre- Offer Equity Share capital (%)
1.	Gurdeep Soni	8,995,090	19.93
2.	Ashoka Investment Holdings Limited	7,180,642	15.91
3.	The Paramjit Soni 2018 CG-NG Nevada Trust	6,395,090	14.17
4.	The Karan Soni 2018 CG-NG Nevada Trust	5,200,000	11.52
5.	The Meher Soni 2018 CG-NG Nevada Trust	5,200,000	11.52
6.	Pamela Soni	3,000,000	6.65
7.	Ambadevi Mauritius Holding Limited	2,154,192	4.77
8.	Angad Soni	2,000,000	4.43
9.	Arjun Soni	2,000,000	4.43
10.	Tanya Kohli	1,000,000	2.22
11.	Uniparts ESOP Trust	916,002	2.03
	<b>Total</b>	<b>44,041,016</b>	<b>97.58</b>

The Shareholders holding 1% or more of the equity paid-up capital of our Company as on one year prior to the date of filing of this Draft Red Herring Prospectus is as follows:

S. No.	Name of the Shareholder	Number of Equity Shares	Percentage of the pre- Offer Equity Share capital (%)
1.	Gurdeep Soni	8,995,090	19.93

S. No.	Name of the Shareholder	Number of Equity Shares	Percentage of the pre-Offer Equity Share capital (%)
2.	Ashoka Investment Holdings Limited	7,180,642	15.91
3.	The Paramjit Soni 2018 CG-NG Nevada Trust	6,395,090	14.17
4.	The Karan Soni 2018 CG-NG Nevada Trust	5,200,000	11.52
5.	The Meher Soni 2018 CG-NG Nevada Trust	5,200,000	11.52
6.	Pamela Soni	3,000,000	6.65
7.	Ambadevi Mauritius Holding Limited	2,154,192	4.77
8.	Angad Soni	2,000,000	4.43
9.	Arjun Soni	2,000,000	4.43
10.	Uniparts ESOP Trust	1,027,200	2.28
11.	Tanya Kohli	1,000,000	2.22
	<b>Total</b>	<b>44,152,214</b>	<b>97.83</b>

The Shareholders holding 1% or more of the equity paid-up capital of our Company as on two years prior to filing of this Draft Red Herring Prospectus is as follows:

S. No.	Name of the Shareholder	Number of Equity Shares	Percentage of the pre-Offer Equity Share capital (%)
1.	Gurdeep Soni	14,955,570	33.14
2.	The Paramjit Soni 2018 CG-NG Nevada Trust	5,595,090	12.40
3.	The Karan Soni 2018 CG-NG Nevada Trust	4,000,000	8.86
4.	The Meher Soni 2018 CG-NG Nevada Trust	3,700,000	8.20
5.	Ashoka Investment Holdings Limited	7,180,642	15.91
6.	Paramjit Singh Soni	1,000,000	2.22
7.	Meher Soni	1,500,000	3.32
8.	Karan Soni	1,200,000	2.66
9.	Ambadevi Mauritius Holding Limited	2,154,192	4.77
10.	Pamela Soni	1,979,520	4.39
11.	Uniparts ESOP Trust	1,027,200	2.28
	<b>Total</b>	<b>44,292,214</b>	<b>98.15</b>

#### Details of price at which specified securities were acquired in the last three years immediately preceding the date of this Draft Red Herring Prospectus

Except as stated below, none of the Promoters, Promoter Group and the Selling Shareholders have acquired any specified securities in the last three years immediately preceding the date of this Draft Red Herring Prospectus:

S. No.	Name of the acquirer/ shareholder	Date of acquisition of Equity Shares	Number of Equity Shares	Face value of Equity Share (in ₹)	Acquisition price per Equity Share (in ₹)*
<b>Promoter Group</b>					
1.	The Paramjit Soni 2018 CG-NG Nevada Trust	December 9, 2020	800,000	10	Nil <sup>(1)</sup>
2.	The Karan Soni 2018 CG-NG Nevada Trust	December 9, 2020	1,200,000	10	Nil <sup>(1)</sup>
3.	The Meher Soni 2018 CG-NG Nevada Trust	December 11, 2020	1,500,000	10	Nil <sup>(1)</sup>
4.	Pamela Soni	January 8, 2021	1,020,480	10	Nil <sup>(1)</sup>
5.	Angad Soni	January 8, 2021	1,950,000	10	Nil <sup>(1)</sup>
6.	Arjun Soni	January 8, 2021	1,990,000	10	Nil <sup>(1)</sup>
7.	Tanya Kohli	January 8, 2021	1,000,000	10	Nil <sup>(1)</sup>
8.	Jaswinder Singh Bhogal	January 24, 2021	102,948	10	52.50
<b>Selling Shareholders</b>					
<b>Promoter Group Selling Shareholders</b>					
9.	The Karan Soni 2018 CG-NG Nevada Trust	December 9, 2020	1,200,000	10	Nil <sup>(1)</sup>
10.	The Meher Soni 2018 CG-NG Nevada Trust	December 11, 2020	1,500,000	10	Nil <sup>(1)</sup>
11.	Pamela Soni	January 8, 2021	1,020,480	10	Nil <sup>(1)</sup>

\* As certified by Rakesh Banwari & Co., Chartered Accountants, our Statutory Auditors, by way of their certificate dated April 25, 2022.

<sup>(1)</sup> Represents transfer by way of gift and no consideration was paid.

### Average cost of acquisition for Promoter and the Selling Shareholders

The average cost of acquisition per Equity Share acquired by our Promoters and the Selling Shareholders, as on the date of this Draft Red Herring Prospectus is:

S. No.	Name of entity/ individual	Number of Equity Shares on a fully diluted basis	Average Cost of Acquisition per Equity Share (in ₹)*
<b>Promoters</b>			
1.	Gurdeep Soni	8,995,090	9.97
2.	Paramjit Singh Soni	200,000	9.85
<b>Selling Shareholders</b>			
<b>Promoter Group Selling Shareholders</b>			
3.	The Karan Soni 2018 CG-NG Nevada Trust	5,200,000	Nil <sup>(1)</sup>
4.	The Meher Soni 2018 CG-NG Nevada Trust	5,200,000	Nil <sup>(1)</sup>
5.	Pamela Soni	3,000,000	6.27
<b>Investor Selling Shareholders</b>			
6.	Ashoka Investment Holdings Limited	7,180,642	88.45
7.	Ambadevi Mauritius Holding Limited	2,154,192	88.45
<b>Individual Selling Shareholders</b>			
8.	Andrew Warren Code	177,378	105.74
9.	James Norman Hallene	177,378	105.74
10.	Kevin John Code	177,378	105.74
11.	Dennis Francis DeDecker	57,420	105.74
12.	Melvin Keith Gibbs	41,730	105.74
13.	Walter James Gruber	24,706	105.74
14.	Wendy Reichard Hammen	21,556	105.74
15.	Mark Louis Dawson	20,870	147.36
16.	Bradley Lorenz Miller	16,366	105.74
17.	Mary Louise Arp	10,440	105.74
18.	Diana Lynn Craig	8,340	105.74
19.	Marc Christopher Dorau	7,710	105.74
20.	Craig A Johnson	5,010	105.74
21.	Misty Marie Garcia	826	105.64

\* As certified by Rakesh Banwari & Co., Chartered Accountants, our Statutory Auditors, by way of their certificate dated April 25, 2022.

<sup>(1)</sup> Represents transfer by way of gift and no consideration was paid.

10. None of the Equity Shares being offered for sale through the Offer for Sale are pledged or otherwise encumbered, as on the date of this Draft Red Herring Prospectus.
11. Our Company, our Directors and the BRLMs have not made or entered into any buy-back arrangements for the purchase of Equity Shares.
12. Neither the BRLMs and nor their respective associates as defined in the SEBI Merchant Bankers Regulations, hold any Equity Shares as on the date of filing of this Draft Red Herring Prospectus.
13. No person connected with the Offer, including, but not limited to the BRLMs, the Syndicate Members, our Company, the Promoters, our Directors, or the members of the Promoter Group, shall offer in any manner whatsoever any incentive, whether direct or indirect, in cash or kind or services or otherwise to any Bidder for making a Bid, except for fees or commission for services rendered in relation to the Offer.
14. The Equity Shares are fully paid-up and there are no partly paid-up Equity Shares as on the date of filing this Draft Red Herring Prospectus. The Equity Shares to be transferred pursuant to the Offer are fully paid-up and will be at the time of Allotment.
15. Except for outstanding options granted pursuant to ESOP 2007, our Company has no outstanding warrants, options to be issued or rights to convert debentures, loans or other convertible instruments into Equity Shares

as on the date of this Draft Red Herring Prospectus.

16. Our Company presently does not intend or propose to alter its capital structure for a period of six months from the Bid/Offer Opening Date, by way of split or consolidation of the denomination of Equity Shares or further issue of Equity Shares (including issue of securities convertible into or exchangeable, directly or indirectly for Equity Shares) whether on a preferential basis or by way of issue of bonus shares or on a rights basis or by way of further public issue of Equity Shares or otherwise.
17. There will be no further issue of Equity Shares whether by way of issue of bonus shares, preferential allotment, rights issue or in any other manner during the period commencing from filing of this Draft Red Herring Prospectus with the SEBI until the Equity Shares have been listed on the Stock Exchanges, or all application monies have been refunded, as the case may be.
18. During the period of six months immediately preceding the date of filing of this Draft Red Herring Prospectus, no financing arrangements existed whereby our Promoters, members of our Promoter Group, our Directors and their relatives may have financed the purchase of securities of our Company by any other person.
19. Our Promoters and members of our Promoter Group will not submit Bids in this Offer. Other than The Karan Soni 2018 CG-NG Nevada Trust, The Meher Soni 2018 CG-NG Nevada Trust and Pamela Soni who are offering up to 1,700,000 Equity Shares, 1,700,000 Equity Shares and 2,250,000 Equity Shares, respectively, the members of our Promoter Group will not participate in this Offer.
20. There shall be only one denomination of the Equity Shares.
21. Our Company shall ensure that transactions in the Equity Shares by the Promoters and the Promoter Group, if any, during the period between the date of filing of the Draft Red Herring Prospectus and the date of closure of the Offer shall be reported to the Stock Exchanges within 24 hours of the transactions.
22. Employee Stock Option Schemes of our Company

#### **ESOP 2007**

Our Company instituted an employee stock option plan, namely, the Uniparts Employee Stock Option Plan 2007 (“**ESOP 2007**”), pursuant to a resolution of the Board dated January 8, 2007 and resolution of the Shareholders dated February 2, 2007, which has been amended by the Board on April 4, 2014, September 26, 2015 and March 22, 2022, respectively, and by special resolution of the Shareholders dated February 3, 2018, November 27, 2018 and April 23, 2022. Our Company has established an employee stock option trust (“**Uniparts ESOP Trust**”) to administer ESOP 2007 of our Company. The objective of ESOP 2007 is to retain and attract key talent, replace current performance bonus with long term incentive, and to create wealth opportunities for employees. ESOP 2007 is in compliance with the Securities and Exchange Board of India (Share Based Employee Benefits and Sweat Equity) Regulations, 2021.

Under ESOP 2007, an aggregate of 1,039,200 options have been granted, and an aggregate of 123,198 options have vested and exercised as on the date of this Draft Red Herring Prospectus. As on the date of this Draft Red Herring Prospectus, the Uniparts ESOP Trust holds 916,002 Equity Shares.

The details of ESOP 2007, as certified by Rakesh Banwari & Co., Chartered Accountants, through a certificate dated April 25, 2022 are as follows:

<b>Particulars</b>	<b>Details</b>													
Options granted	<table border="1"> <thead> <tr> <th style="text-align: center;">Financial Year/Period</th> <th style="text-align: center;">Total No. of Options Granted</th> </tr> </thead> <tbody> <tr> <td style="text-align: center;">Financial Year ended 2019</td> <td style="text-align: center;">292,500</td> </tr> <tr> <td style="text-align: center;">Financial Year ended 2020</td> <td style="text-align: center;">25,000</td> </tr> <tr> <td style="text-align: center;">Financial Year ended 2021</td> <td style="text-align: center;">102,948</td> </tr> <tr> <td style="text-align: center;">From April 1, 2021 to December 31, 2021</td> <td style="text-align: center;">69,912</td> </tr> <tr> <td style="text-align: center;">From January 1, 2022 till the date of filing of this Draft Red Herring Prospectus</td> <td style="text-align: center;">-</td> </tr> </tbody> </table>		Financial Year/Period	Total No. of Options Granted	Financial Year ended 2019	292,500	Financial Year ended 2020	25,000	Financial Year ended 2021	102,948	From April 1, 2021 to December 31, 2021	69,912	From January 1, 2022 till the date of filing of this Draft Red Herring Prospectus	-
Financial Year/Period	Total No. of Options Granted													
Financial Year ended 2019	292,500													
Financial Year ended 2020	25,000													
Financial Year ended 2021	102,948													
From April 1, 2021 to December 31, 2021	69,912													
From January 1, 2022 till the date of filing of this Draft Red Herring Prospectus	-													
No. of employees to whom options were granted	Employees of the Company: 17 Employees of the Subsidiaries: 8													
Options outstanding														

Particulars	Details	
	<b>Financial Year/Period</b>	<b>Total No. of Options Outstanding</b>
	Financial Year ended 2019	936,488
	Financial Year ended 2020	961,488
	Financial Year ended 2021	961,488
	From April 1, 2021 to December 31, 2021	1,018,950
	From January 1, 2022 till the date of filing of this Draft Red Herring Prospectus	916,002
The pricing formula	Black Scholes Option Valuation Model has been used for determining the fair value of an option granted under ESOP scheme.	
Exercise price of options	<b>Financial Year/Period</b>	<b>Amount (In Rs.)</b>
	Financial Year ended 2019	52.50
	Financial Year ended 2020	52.50
	Financial Year ended 2021	52.50
	From April 1, 2021 to December 31, 2021	52.50
	From January 1, 2022 till the date of filing of this Draft Red Herring Prospectus	-
Options vested [(excluding options that have been exercised)]	<b>Financial Year/Period</b>	<b>Total No. of Options Vested</b>
	Financial Year ended 2019	643,988
	Financial Year ended 2020	643,988
	Financial Year ended 2021	637,565
	From April 1, 2021 to December 31, 2021	877,671
	From January 1, 2022 till the date of filing of this Draft Red Herring Prospectus	774,723
Options exercised	<b>Financial Year/Period</b>	<b>Total No. of Options Exercised</b>
	Financial Year ended 2019	Nil
	Financial Year ended 2020	Nil
	Financial Year ended 2021	Nil
	From April 1, 2021 to December 31, 2021	8,250
	From January 1, 2022 till the date of filing of this Draft Red Herring Prospectus	102,948
Total no. of Equity Shares that would arise as a result of full exercise of options granted [(net of cancelled options)]	<b>Financial Year/Period</b>	<b>Total No. of Equity Shares</b>
	Financial Year ended 2019	292,500
	Financial Year ended 2020	25,000
	Financial Year ended 2021	102,948
	From April 1, 2021 to December 31, 2021	69,912
	From January 1, 2022 till the date of filing of this Draft Red Herring Prospectus	-
Options forfeited/lapsed/cancelled	<b>Financial Year/Period</b>	<b>Total No. of Options forfeited</b>
	Financial Year ended 2019	Nil
	Financial Year ended 2020	Nil
	Financial Year ended 2021	102,948
	From April 1, 2021 to December 31, 2021	4,200
	From January 1, 2022 till the date of filing of this Draft Red Herring Prospectus	-
Variation in terms of options	<b>Financial Year/Period</b>	<b>Variation in terms of options</b>
	Financial Year ended 2019	Nil
	Financial Year ended 2020	Nil

Particulars	Details																			
	Financial Year ended 2021	Nil																		
	From April 1, 2021 to December 31, 2021	Nil																		
	From January 1, 2022 till the date of filing of this Draft Red Herring Prospectus	Nil																		
Money realised by exercise of options	<table border="1" style="width: 100%;"> <thead> <tr> <th style="background-color: #cccccc;">Financial Year/Period</th> <th style="background-color: #cccccc;">Amount (In Rs.)</th> </tr> </thead> <tbody> <tr> <td>Financial Year ended 2019</td> <td>Nil</td> </tr> <tr> <td>Financial Year ended 2020</td> <td>Nil</td> </tr> <tr> <td>Financial Year ended 2021</td> <td>Nil</td> </tr> <tr> <td>From April 1, 2021 to December 31, 2021</td> <td>433,125.00</td> </tr> <tr> <td>From January 1, 2022 till the date of filing of this Draft Red Herring Prospectus</td> <td>5,404,770.00</td> </tr> </tbody> </table>		Financial Year/Period	Amount (In Rs.)	Financial Year ended 2019	Nil	Financial Year ended 2020	Nil	Financial Year ended 2021	Nil	From April 1, 2021 to December 31, 2021	433,125.00	From January 1, 2022 till the date of filing of this Draft Red Herring Prospectus	5,404,770.00						
Financial Year/Period	Amount (In Rs.)																			
Financial Year ended 2019	Nil																			
Financial Year ended 2020	Nil																			
Financial Year ended 2021	Nil																			
From April 1, 2021 to December 31, 2021	433,125.00																			
From January 1, 2022 till the date of filing of this Draft Red Herring Prospectus	5,404,770.00																			
Total no. of options in force	<table border="1" style="width: 100%;"> <thead> <tr> <th style="background-color: #cccccc;">Financial Year/Period</th> <th style="background-color: #cccccc;">Total No. of Options in force</th> </tr> </thead> <tbody> <tr> <td>Financial Year ended 2019</td> <td>643,988</td> </tr> <tr> <td>Financial Year ended 2020</td> <td>643,988</td> </tr> <tr> <td>Financial Year ended 2021</td> <td>637,565</td> </tr> <tr> <td>From April 1, 2021 to December 31, 2021</td> <td>877,671</td> </tr> <tr> <td>From January 1, 2022 till the date of filing of this Draft Red Herring Prospectus</td> <td>774,723</td> </tr> </tbody> </table>		Financial Year/Period	Total No. of Options in force	Financial Year ended 2019	643,988	Financial Year ended 2020	643,988	Financial Year ended 2021	637,565	From April 1, 2021 to December 31, 2021	877,671	From January 1, 2022 till the date of filing of this Draft Red Herring Prospectus	774,723						
Financial Year/Period	Total No. of Options in force																			
Financial Year ended 2019	643,988																			
Financial Year ended 2020	643,988																			
Financial Year ended 2021	637,565																			
From April 1, 2021 to December 31, 2021	877,671																			
From January 1, 2022 till the date of filing of this Draft Red Herring Prospectus	774,723																			
Employee wise details of options granted to																				
(i) Senior managerial personnel, i.e. Directors and key management personnel	<table border="1" style="width: 100%;"> <thead> <tr> <th style="background-color: #cccccc;">Name of senior managerial personnel</th> <th style="background-color: #cccccc;">Total no. of options granted</th> </tr> </thead> <tbody> <tr> <td>Herbert Coenen</td> <td>451,336</td> </tr> <tr> <td>Sudhakar Kolli</td> <td>100,000</td> </tr> <tr> <td>Munish Sapra</td> <td>29,912</td> </tr> </tbody> </table>		Name of senior managerial personnel	Total no. of options granted	Herbert Coenen	451,336	Sudhakar Kolli	100,000	Munish Sapra	29,912										
Name of senior managerial personnel	Total no. of options granted																			
Herbert Coenen	451,336																			
Sudhakar Kolli	100,000																			
Munish Sapra	29,912																			
(ii) Any other employee who received a grant in any one year of options amounting to 5% or more of the options granted during the year	<table border="1" style="width: 100%;"> <thead> <tr> <th style="background-color: #cccccc;">Name of employee</th> <th style="background-color: #cccccc;">Total no. of options granted</th> </tr> </thead> <tbody> <tr> <td>Rini Kalra*</td> <td>167,878</td> </tr> <tr> <td>Jyotbir Singh Sethi</td> <td>35,000</td> </tr> <tr> <td>Sameer Malhotra</td> <td>15,000</td> </tr> <tr> <td>Biru Gupta</td> <td>20,000</td> </tr> <tr> <td>Satya Narayan</td> <td>17,500</td> </tr> <tr> <td>Ayushman Kachru</td> <td>7,500</td> </tr> <tr> <td>Jaswinder Singh Bhogal</td> <td>102,948</td> </tr> <tr> <td>Vivek Maheshwari</td> <td>5,000</td> </tr> </tbody> </table>		Name of employee	Total no. of options granted	Rini Kalra*	167,878	Jyotbir Singh Sethi	35,000	Sameer Malhotra	15,000	Biru Gupta	20,000	Satya Narayan	17,500	Ayushman Kachru	7,500	Jaswinder Singh Bhogal	102,948	Vivek Maheshwari	5,000
Name of employee	Total no. of options granted																			
Rini Kalra*	167,878																			
Jyotbir Singh Sethi	35,000																			
Sameer Malhotra	15,000																			
Biru Gupta	20,000																			
Satya Narayan	17,500																			
Ayushman Kachru	7,500																			
Jaswinder Singh Bhogal	102,948																			
Vivek Maheshwari	5,000																			
(iii) Identified employees who are granted options, during any one year equal to or exceeding 1% of the issued capital (excluding outstanding warrants and conversions) of our Company at the time of grant	<table border="1" style="width: 100%;"> <thead> <tr> <th style="background-color: #cccccc;">Name of employee</th> <th style="background-color: #cccccc;">Total no. of options granted</th> </tr> </thead> <tbody> <tr> <td colspan="2" style="text-align: center;">NIL</td> </tr> </tbody> </table>		Name of employee	Total no. of options granted	NIL															
Name of employee	Total no. of options granted																			
NIL																				
Fully diluted EPS on a pre-Offer basis on exercise of options calculated in accordance with the applicable accounting standard 'Earning Per Share'	<table border="1" style="width: 100%;"> <thead> <tr> <th style="background-color: #cccccc;">Financial Year/Period</th> <th style="background-color: #cccccc;">Reported EPS as per Financial Statements</th> <th style="background-color: #cccccc;">Diluted Restated Financial Statements</th> </tr> </thead> <tbody> <tr> <td>Financial Year ended 2019</td> <td>15.42</td> <td></td> </tr> <tr> <td>Financial Year ended 2020</td> <td>13.88</td> <td></td> </tr> <tr> <td>Financial Year ended 2021</td> <td>20.47</td> <td></td> </tr> <tr> <td>From April 1, 2021 to December 31, 2021</td> <td>27.11</td> <td></td> </tr> </tbody> </table>		Financial Year/Period	Reported EPS as per Financial Statements	Diluted Restated Financial Statements	Financial Year ended 2019	15.42		Financial Year ended 2020	13.88		Financial Year ended 2021	20.47		From April 1, 2021 to December 31, 2021	27.11				
Financial Year/Period	Reported EPS as per Financial Statements	Diluted Restated Financial Statements																		
Financial Year ended 2019	15.42																			
Financial Year ended 2020	13.88																			
Financial Year ended 2021	20.47																			
From April 1, 2021 to December 31, 2021	27.11																			
Difference between employee compensation cost calculated using the intrinsic value of stock options and the employee compensation cost that shall have been recognised if our Company had used fair value of options and impact of this difference on profits and EPS of our Company for the last three fiscals	Not applicable since the Company has used fair value of options for the purposes of recognizing employees compensation cost.																			
Weighted-average exercise prices and weighted-average fair values of options shall be disclosed separately for options whose	Not applicable as market price of the stock is not available for the Company as it is an unlisted company.																			

Particulars	Details			
-------------	---------	--	--	--

exercise price either equals or exceeds or is less than the market price of the stock

Description of the method and significant assumptions used during the year to estimate the fair values of options, including weighted-average information, namely, risk-free interest rate, expected life, expected volatility, expected dividends and the price of the underlying share in market at the time of grant of the option

Particulars	March 31, 2019	March 31, 2020	March 31, 2021	Nine month ending Dec 31, 2021
Weighted average share price	84.91	79.11	129.55	198.23
Exercise Price	52.50	52.50	52.50	52.50
Volatility	14.83%	14.74%	50.30%	48.30%
Life of the options granted in years	15	15	15	15
Average risk-free interest rate	7.92	6.73	4.19	5.26

Impact on profits and EPS of the last three years if our Company had followed the accounting policies specified in Regulation 15 of the ESOP Regulations in respect of options granted in the last three years

Fiscal	Effect on Profits	Effect on EPS
March 31, 2021	4.03	0.09
March 31, 2020	5.85	0.14
March 31, 2019	1.99	0.04

*Pursuant to ESOP 2007, the Company has issued 123,198 Equity Shares to 4 employees of the Company.*

*\*Rini Kalra was an employee of GFPL, till March 31, 2020.*



## OBJECTS OF THE OFFER

The objects of the Offer are to (i) to carry out the Offer for Sale of up to 15,731,942 Equity Shares by the Selling Shareholders; and (ii) achieve the benefits of listing the Equity Shares on the Stock Exchanges. Our Company will not receive any proceeds from the Offer and all such proceeds (net of any Offer related expenses to be borne by the Selling Shareholders) will go to the Selling Shareholders. For details of the Selling Shareholder and the number of Equity Shares offered by the Selling Shareholder in the Offer see “*The Offer*” on page 76.

Further, our Company expects that listing of the Equity Shares will enhance our visibility and brand image and provide liquidity to our Shareholders and will also provide a public market for the Equity Shares in India.

### Utilisation of the Offer Proceeds by Selling Shareholders

Our Company will not directly receive any proceeds from the Offer (the “**Offer Proceeds**”) and all the Offer Proceeds will be received by the Selling Shareholders, in proportion to the Offered Shares sold by the respective Selling Shareholders as part of the Offer. For details of Offered Shares by each Selling Shareholder, see “*Other Regulatory and Statutory Disclosures*” beginning on page 395.

### Offer Related Expenses

The total expenses of the Offer are estimated to be approximately ₹ [●] million. The expenses of this Offer include, among others, listing fees, selling commission and brokerage, fees payable to the BRLMs, fees payable to legal counsel, fees payable to the Registrar to the Offer, Escrow Collection Bank(s) and Sponsor Bank to the Offer, processing fee to the SCSBs for processing application forms, brokerage and selling commission payable to members of the Syndicate, Registered Brokers, RTAs and CDPs, printing and stationery expenses, advertising and marketing expenses and all other incidental and miscellaneous expenses for listing the Equity Shares on the Stock Exchanges.

Other than listing fees, which will be paid by the Company, the costs, fees and expenses directly related to the Offer shall be borne by the Selling Shareholders in proportion to the Equity Shares contributed by them in the Offer and as mutually agreed and in accordance with Applicable Law. All expenses (other than listing fees) relating to the Offer shall be paid by the Company on behalf of the Selling Shareholders in the first instance, until the date of Allotment in the Offer. Upon the successful completion of the Offer, or in the event the Offer is withdrawn or unsuccessful, each Selling Shareholder shall reimburse the Company for any expenses which were mutually agreed in accordance with applicable law, incurred by the Company on behalf of such Selling Shareholder. However, each Selling Shareholder shall have an option to pay its respective expenses directly, and to the extent of such payment, such Selling Shareholder shall not be required to reimburse the Company.

The estimated Offer expenses are as follows:

Activity	Estimated expenses* (in ₹ million)	As a% of the total estimated Offer expenses	As a% of the total Offer size
Fees payable to the BRLMs	[●]	[●]	[●]
Advertising and marketing expenses	[●]	[●]	[●]
Fees payable to the Registrar to the Offer	[●]	[●]	[●]
Commission/processing fee for SCSBs, Sponsor Bank and Banker to the Offer. Brokerage, underwriting commission and selling commission and bidding charges for Members of the Syndicate, Registered Brokers, RTAs and CDPs <sup>(1)(2)</sup>	[●]	[●]	[●]
Printing and distribution of issue stationery	[●]	[●]	[●]
Others	[●]	[●]	[●]
(1) Listing fees, SEBI filing fees, upload fees, BSE & NSE processing fees, book building software fees and other regulatory expenses			
(2) Miscellaneous.			
<b>Total estimated Offer expenses</b>	[●]	[●]	[●]

\* Offer expenses include goods and services tax, where applicable. Offer expenses will be incorporated at the time of filing of the Prospectus.  
 \*\* Offer expenses are estimates and are subject to change.

1 Selling commission payable to members of the Syndicate, SCSBs, RTAs and CDPs on the amounts received against the Equity Shares Allotted (i.e. product of the Equity Shares Allotted and the Offer Price) would be as follows:

Portion for Retail Individual Investors	/●]%(plus applicable goods and services tax)
Portion for Non-Institutional Investors	/●]%(plus applicable goods and services tax)

Further, bidding charges of ₹ [●] (plus applicable goods and services tax) shall be per valid ASBA Form collected by the Syndicate, RTAs and CDPs (excluding applications made by UPI Bidders using the UPI Mechanism). The terminal from which the Bid has been uploaded will be taken into account in order to determine the total bidding charges. No additional bidding charges shall be payable to SCSBs on the Bid cum Application Forms directly procured by them. Selling commission payable to the Registered Brokers on the portion for Retail Individual Investors and Non-Institutional Investors, which are directly procured by the Registered Brokers and submitted to SCSB for processing, shall be ₹ [●] per valid Bid cum Application Form (plus applicable goods and services tax).

Processing fees payable to the SCSBs for Bid cum Application Forms which are procured by the Registered Brokers/RTAs/CDPs and submitted to the SCSB for blocking shall be ₹ [●] per valid Bid cum Application Form (plus applicable taxes).

Processing fees for applications made by UPI Bidders using the UPI Mechanism would be as follows:

RTAs/ CDPs/ Registered Brokers	₹ [●] per valid Bid cum Application Form (plus applicable taxes)
	₹ [●] per valid Bid cum Application Form (plus applicable taxes)
Sponsor Bank	The Sponsor Bank shall be responsible for making payments to third parties such as the remitter bank, the NPCI and such other parties as required in connection with the performance of its duties under applicable SEBI circulars, agreements and other Applicable Laws.

\* Based on valid Bid cum Application Forms

The processing fees for applications made by UPI Bidders using the UPI Mechanism may be released to the remitter banks (SCSBs) only after such banks provide a written confirmation on compliance with SEBI circular no. SEBI/HO/CFD/DIL2/P/CIR/2021/570 dated June 2, 2021 read with SEBI circular no. SEBI/HO/CFD/DIL2/CIR/P/2021/2480/1/M dated March 16, 2021 and SEBI circular no. SEBI/HO/CFD/DIL2/CIR/P/2022/51 dated April 20, 2022.

## BASIS OF OFFER PRICE

The Offer Price will be determined by our Company and the Investor Selling Shareholders in consultation with the BRLMs, on the basis of assessment of market demand for the Equity Shares offered through the Book Building Process and on the basis of quantitative and qualitative factors as described below. The face value of the Equity Shares is ₹ 10 each and the Offer Price is [●] times the face value at the lower end of the Price Band and [●] times the face value at the higher end of the Price Band. Investors should also refer to “*Risk Factors*”, “*Our Business*”, “*Financial Statements*” and “*Management’s Discussion and Analysis of Financial Condition and Results of Operations*” on pages 27, 149, 212 and 355, respectively, to have an informed view before making an investment decision.

### Qualitative Factors

Some of the qualitative factors which form the basis for computing the Offer Price are:

- Leading market presence in global off-highway vehicle systems and components segment
- Engineering driven, vertically integrated precision solutions provider
- Global business model optimizing cost-competitiveness and customer supply chain risks
- Long-term relationships with key global customers, including major OEMs, resulting in a well-diversified revenue base
- Strategically located manufacturing and warehousing facilities that offer scale and flexibility
- Strong financial position with robust financial performance metrics
- Experienced Promoters and qualified senior management team

For further details, see “*Our Business – Strengths*” on page 152.

### Quantitative Factors

The information presented below relating to our Company is based on the Restated Financial Statements. For further details, see “*Restated Financial Statements*” on page 212.

Some of the quantitative factors which may form the basis for calculating the Offer Price are as follows:

#### A. Basic and Diluted Earnings per Share (“EPS”) at face value of ₹ 10 each:

As derived from the Restated Financial Statements:

Year ended	Basic EPS (₹)	Diluted EPS (₹)	Weight
March 31, 2021	20.95	20.47	3
March 31, 2020	14.20	13.88	2
March 31, 2019	15.78	15.42	1
<b>Weighted Average</b>	<b>17.84</b>	<b>17.43</b>	
Nine month period ended December 31, 2021*	27.73	27.11	

\*Not Annualised

Notes:

1. Earning per shares (EPS) calculation is in accordance with the Indian Accounting Standard (Ind AS) 33 'Earnings per share' prescribed by the Companies (Indian Accounting Standards) Rules, 2015. The face value of Equity Shares of the Company is ₹10. The ratios have been computed as below:

- a) Basic earnings per share (INR) = Net profit after tax as per the statement of profit and loss attributable to the equity shareholders of the Company / weighted average number of equity shares outstanding during the period.
- b) Diluted earnings per share (INR) = Net profit after tax as per the statement of profit and loss attributable to the equity shareholders of the Company / weighted average number of shares outstanding, for the effects of all dilutive potential equity shares .

2. *Weighted average number of equity shares is the number of equity shares outstanding at the beginning of the year adjusted by the number of equity shares issued during the year multiplied by the time weighting factor. The time weighting factor is the number of days for which the specific shares are outstanding as a proportion of total number of days during the year.*

**B. Price/Earning (“P/E”) ratio in relation to Price Band of ₹ [●] to ₹ [●] per Equity Share:**

Particulars	P/E at the Floor Price (no. of times)	P/E at the Cap Price (no. of times)
Based on basic EPS for Financial Year 2021 on Restated Financial Statements	[●]	[●]
Based on diluted EPS for Financial Year 2021 on Restated Financial Statements	[●]	[●]

**Industry Peer Group P/E ratio**

There are no listed entities in India whose business portfolio is comparable with that of the Company.

**C. Return on Net Worth (“RoNW”)**

As derived from the Restated Financial Statements:

Financial Year ended / Period ended	RoNW (%)	Weight
March 31, 2021	16.52	3
March 31, 2020	13.50	2
March 31, 2019	16.49	1
<b>Weighted Average</b>	<b>15.51</b>	
Nine month period ended December 31, 2021*	18.37	

\*Not Annualised

Notes:

1. *RoNW is calculated as net profit after taxation and minority tax attributable to the equity shareholders of the Company divided by shareholders' funds, for that year.*
2. *Shareholders' funds = Share capital + reserves and surplus – revaluation reserves.*

**D. Net Asset Value per Equity Share (Face value of ₹ 10 each)**

Net Asset Value per Equity Share	Consolidated (₹)
As on December 31, 2021	147.55
As on March 31, 2021	123.94
As on March 31, 2020	102.84
As on March 31, 2019	93.50
After the Offer - Offer Price	[●]

Notes:

1. *Net Asset Value per Equity Share has been computed as net worth as at the end of the Fiscal Year, as restated divided by total number of Equity Shares outstanding at the end of the period/year.*

As the Offer consists only of an offer for sale by the Selling Shareholders, there will be no change in the Net Asset Value per Equity Share post completion of the Offer.

**E. Comparison with Listed Industry Peers**

Our Company does not have any listed industry peers in India. Accordingly, it is not possible to provide an industry comparison in relation to our Company.

**F. The Offer price is [●] times of the face value of the Equity Shares.**

The Offer Price of ₹ [●] has been determined by our Company and the Investor Selling Shareholders in consultation with the BRLMs, on the basis of demand from investors for Equity Shares through the Book Building Process and, is justified in view of the above qualitative and quantitative parameters. The

trading price of the Equity Shares could decline due to the factors mentioned in the “*Risk Factors*” on page 27 and you may lose all or part of your investments.

## STATEMENT OF POSSIBLE SPECIAL TAX BENEFITS

Date: April 25, 2022

To,

The Board of Directors  
**Uniparts India Limited**  
Gripwel House, Block-5 C6&7  
Vasant Kunj  
New Delhi – 110070  
(the “Company”)

**Re: Proposed initial public offering of equity shares of ₹10 each (the “Equity Shares”) of Uniparts India Limited (the “Company” and such offer, the “Offer”)**

Dear Sir(s),

We, Rakesh Banwari & Co., (Firm Registration Number: 009732N), Statutory Auditor of the Company, report that the enclosed statement in the **Annexure**, states the possible special tax benefits, available to the Company and its shareholders, under the direct and indirect tax laws presently in force in India, as on the date of this certificate. Several of these benefits are dependent on the Company and its shareholders, fulfilling the conditions prescribed under the relevant provisions of the statute. Hence, the ability of the Company or its shareholders to derive the special tax benefits is dependent upon their fulfilling such conditions, which based on business imperatives the Company or its shareholders face in the future, the Company and its shareholders may or may not choose to fulfil.

We confirm that: Gripwel Fasteners Pvt. Ltd., Uniparts USA Ltd., Uniparts India GMBH, Uniparts Olsen Inc., are material subsidiaries, either incorporated in India or abroad, of the Company, in terms of the Regulation 16, Regulation 24 of the Securities and Exchange Board of India (Listing Obligations and Disclosure Requirements) Regulations, 2015 and in terms of the ‘Policy on Material Subsidiary Companies’ of the Company issued on March 22<sup>nd</sup>, 2022.

The benefits discussed in the enclosed **Annexure** are not exhaustive. This statement is only intended to provide general information to the investors and is neither designed nor intended to be a substitute for professional tax advice. In view of the individual nature of the tax consequences and the changing tax laws, each investor is advised to consult his or her own tax consultant with respect to the specific tax implications arising out of their participation in the Offer. We are neither suggesting nor advising the investor to invest in the Offer based on this statement.

We do not express any opinion or provide any assurance as to whether:

- (i) the Company and its shareholders will continue to obtain these benefits in future; or
- (ii) the conditions prescribed for availing the benefits have been/would be met with.

The contents of the enclosed statement are based on information, explanations and representations obtained from the Company and on the basis of our understanding of the business activities and operations of the Company.

We also consent to the references to us as “Experts” as defined under Section 2(38) of the Companies Act, 2013, read with Section 26(5) of the Companies Act, 2013 to the extent of the certification provided hereunder and included in the draft red herring prospectus of the Company or in any other documents in connection with the Offer.

We hereby give consent to include this statement of special tax benefits in the draft red herring prospectus, and in any other material used in connection with the Offer.

We hereby confirm that while providing this certificate we have complied with the Code of Ethics and the Standard on Quality Control (SQC) 1, Quality Control for Firms that Perform Audits and Reviews of Historical Financial Information, and Other Assurance and Related Services Engagements, issued by the Institute of Chartered Accountants of India.

We have conducted our examination in accordance with the 'Guidance Note on Audit Reports and Certificates for Special Purposes (Revised 2016)' issued by the Institute of Chartered Accountants of India. The Guidance Note requires that we comply with the ethical requirements of the Code of Ethics issued by ICAI.

We confirm that the information in this certificate is true, fair and factually correct, and is in accordance with the requirements of the Companies Act, 2013, the Securities and Exchange Board of India (Issue of Capital and Disclosure Requirements) Regulations, 2018 and other applicable law, and there is no untrue statement or omission which would render the contents of this certificate misleading in its form or context. We confirm that the information in this certificate is adequate and contains all material disclosures to enable the prospective investor to make a well-informed decision.

This certificate is for information and for inclusion (in part or full) in the Offer Documents or any other Offer-related material, and may be relied upon by the Company, the Book Running Lead Managers and the legal advisors appointed by the Company and the Book Running Lead Managers in relation to the Offer. We hereby consent to the submission of this certificate as may be necessary to SEBI, the Registrar of Companies, Delhi & Haryana at Delhi ("RoC"), the relevant stock exchanges, any other regulatory authority and/or for the records to be maintained by the Book Running Lead Managers and in accordance with applicable law. We hereby consent to this certificate being disclosed by the Book Running Lead Managers, if required (i) by reason of any law, regulation or order of a court or by any governmental or competent regulatory authority, or (ii) in seeking to establish a defence in connection with, or to avoid, any actual, potential or threatened legal, arbitral or regulatory proceeding or investigation.

We confirm that we will immediately communicate any changes in writing in the above information to the Book Running Lead Managers until the date when the Equity Shares commence trading on the relevant stock exchanges. In the absence of any such communication from us, the Book Running Lead Managers and the legal advisors, each to the Company and the Book Running Lead Managers, can assume that there is no change to the above information until the Equity Shares commence trading on the relevant stock exchanges pursuant to the Offer. All capitalized terms used herein and not specifically defined shall have the same meaning as ascribed to them in the Offer Documents.

Yours faithfully,  
For Rakesh Banwari & Co.  
Chartered Accountants  
ICAI Firm Registration No. 009732N

**RAKESH AGGARWAL**  
Prop.  
Membership no.: 088193  
ICAI firm registration no: 009732N  
UDIN: 22088193AHSDPT4703  
Date: April 25, 2022

## Annexure

Outlined below are the possible special tax benefits available to the Company, its Material Subsidiaries and Shareholders of the Company under the direct and indirect tax laws in force in India and abroad (i.e. applicable for the Financial Year 2021-22 relevant to the Assessment Year 2022-23).

### A. Special Tax Benefits to the Company and its Material Subsidiaries

#### I. DIRECT TAX

1. The unit of the Company at Vishakhapatnam and a factory of its subsidiary, Gripwel Fasteners Private Limited at Noida, situated in SEZs, are eligible for deduction under sec. 10AA of the Income Tax Act, 1961 to the extent of 50% of the profits derived by the Unit till A.Y. 2023-24 subject to the condition that 50% of the profit of the Unit as debited to the Profit and Loss Account of the previous year in respect of which the deduction is to be allowed and credited to a reserve account (to be called the “Special Economic Zone Reinvestment Reserve Account) and utilized for the purposes of the business of the Company as prescribed hereunder:
  - (i) The amount credited to ‘Special Economic Zone Reinvestment Reserve Account’ is required to be utilized only for the purpose of purchase of plant or machinery in SEZ units only. Such newly acquired plant or machinery should be first put to use before expiry of 3 years following the previous year in which the said reserve has been created.
  - (ii) Further, the amount credited to ‘Special Economic Zone Reinvestment Reserve Account’, until the acquisition of the plant or machinery as mentioned in point 1 above, can be used for the purpose of business of the undertaking. However, the same cannot be used for distribution by way of dividend or profits or for remittance of profits outside India or for creation of any assets outside India.
2. The Subsidiary of the Company, namely Uniparts Olsen Inc. (“**UOI**”) situated in USA is eligible for the following tax benefits-
  - **Iowa Training Program** – The Iowa Industrial New Jobs Training (260E) program provides businesses expanding Iowa’s workforce with new employee training. Employees from UOI attend classes at one of Iowa’s 15 community colleges and their tuition is covered by bonds sold by the college. When UOI withholds Iowa state income tax on behalf of the employee, a portion of the withholding is diverted away from the state and is paid to the college instead. The payment to the college is applied towards the balance of the bonds. UOI is eligible for this program because it is located in Iowa and it is engaged in interstate or intrastate commerce for the purpose of manufacturing, processing, assembling products, warehousing, wholesaling, or conducting research and development.
  - **Work Opportunity Tax Credit** – This is a Federal tax credit available to UOI for hiring individuals from certain targeted groups who have consistently faced significant barriers to employment. WOTC joins other workforce programs that incentivize workplace diversity and facilitate access to good jobs for American workers.

#### II. INDIRECT TAX

- **Goods and Service Tax (GST)** – The unit of the Company at Vishakhapatnam and a factory of its subsidiary, Gripwel Fasteners Private Limited, situated in SEZs, are eligible for import of goods and services without payment of GST.
- **Customs Duty** - The unit of the Company at Vishakhapatnam and a factory of its subsidiary, Gripwel Fasteners Private Limited, situated in SEZs, are eligible for import of goods and services without payment of custom duty.

### B. Special Tax Benefits to the Shareholders of the Company

There are no special tax benefits available to the Shareholders of the Company.



## SECTION IV: ABOUT OUR COMPANY

### INDUSTRY OVERVIEW

Unless otherwise indicated, industry and market data used in this section has been derived from industry publications, in particular, the report titled “**Global market assessment of 3PL and PMP products in Agriculture and Construction Equipment**” dated April, 2022 (the “**CRISIL Report**”), prepared and issued by CRISIL Research appointed on December 15, 2021 pursuant to an engagement letter entered into with our Company, exclusively commissioned and paid for by our Company in connection with the Offer. The data included herein includes excerpts from the CRISIL Report and may have been re-ordered by us for the purposes of presentation. There are no parts, data or information (which may be relevant for the proposed issue), that has been left out or changed in any manner. A copy of the CRISIL Report shall be available on website of our Company at [www.unipartsgroup.com/ipo-industry-reports.asp?links=inv52](http://www.unipartsgroup.com/ipo-industry-reports.asp?links=inv52) in compliance with applicable laws. Industry sources and publications are also prepared based on information as of specific dates and may no longer be current or reflect current trends. Industry sources and publications may also base their information on estimates, projections, forecasts and assumptions that may prove to be incorrect. Accordingly, investors must rely on their independent examination of, and should not place undue reliance on, or base their investment decision solely on this information. The recipient should not construe any of the contents in this report as advice relating to business, financial, legal, taxation or investment matters and are advised to consult their own business, financial, legal, taxation, and other advisors concerning the transaction.

While preparing its report, CRISIL Research has also sourced information from publicly available sources, including our Company’s financial statements available publicly. However, financial information relating to our Company presented in other sections of this Draft Red Herring Prospectus has been prepared in accordance with Ind AS and restated in accordance with the SEBI ICDR Regulations. Accordingly, the financial information of our Company in this section is not comparable with Ind AS financial information presented elsewhere in this Draft Red Herring Prospectus.

### WORLD ECONOMIC OVERVIEW AND OUTLOOK

The global recovery continues, but the momentum has weakened due to the resurgence of COVID-19 infections fuelled by the highly contagious delta and omicron variants. Pandemic outbreaks in critical links of global supply chains have resulted in longer-than-expected supply disruptions, further feeding inflation in many countries. Overall, risks to economic prospects have increased, and policy trade-offs have become more complex.

As per the International Monetary fund (“**IMF**”), the global economy is projected to grow 5.9% in 2021 and 4.9% in 2022. The 2021 global forecast is unchanged from the April 2021 outlook, but with offsetting revisions. Prospects for emerging market and developing economies have been marked down for 2021, especially for emerging Asia. By contrast, the forecast for advanced economies has been revised up. While more widespread vaccine access could improve the outlook, risks on balance are tilted to the downside. The emergence of highly infectious virus variants could derail the recovery. Financial conditions could also tighten abruptly amid stretched asset valuations, if there is a sudden reassessment of the monetary policy outlook, especially in the US.

*IMF estimates of World GDP growth (in %)*

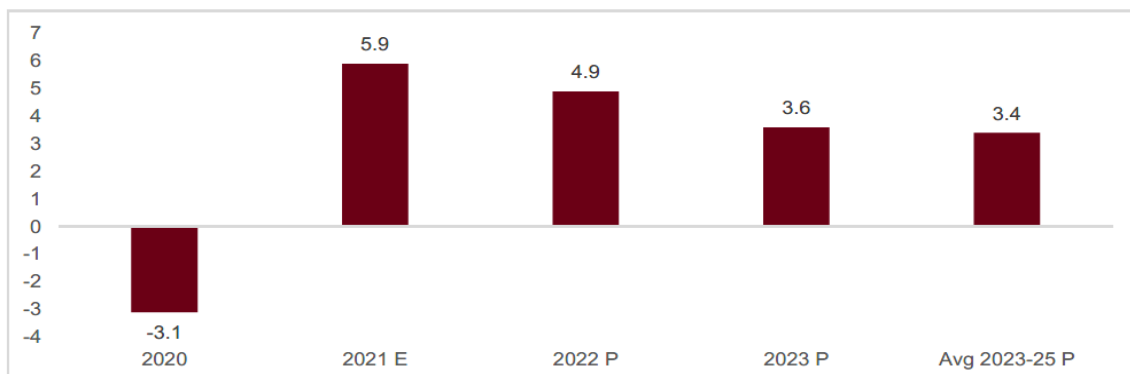

Source: IMF

Note: Period for all years denoted by calendar year

Note: The above projections does not include any impact of the on-going Russia & Ukraine crisis

## Geography-Wise Economic Outlook

### United States

Real GDP is anticipated to grow by 5.6% in 2021, before rising by 3.7% and 2.4% in 2022 and 2023 respectively. Supply disruptions will gradually ease, facilitating a rebuild of business inventories and stronger consumption growth in the near-term. With the continued recovery in the labour market, nominal wage growth will pick up further. While price inflation is projected to moderate in some sectors as supply disruptions abate, higher wages, along with recent increases in housing rents and shipping rates, will lead to stronger overall consumer price growth than prior to the pandemic.

*GDP growth (annual %)*

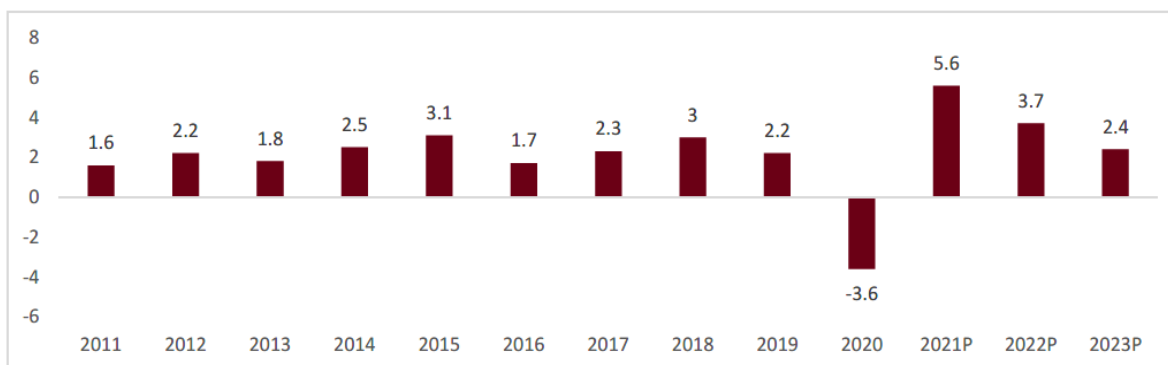

Source: World Bank

Note: The above projections does not include any impact of the on-going Russia & Ukraine crisis

*Share of sector in GVA*

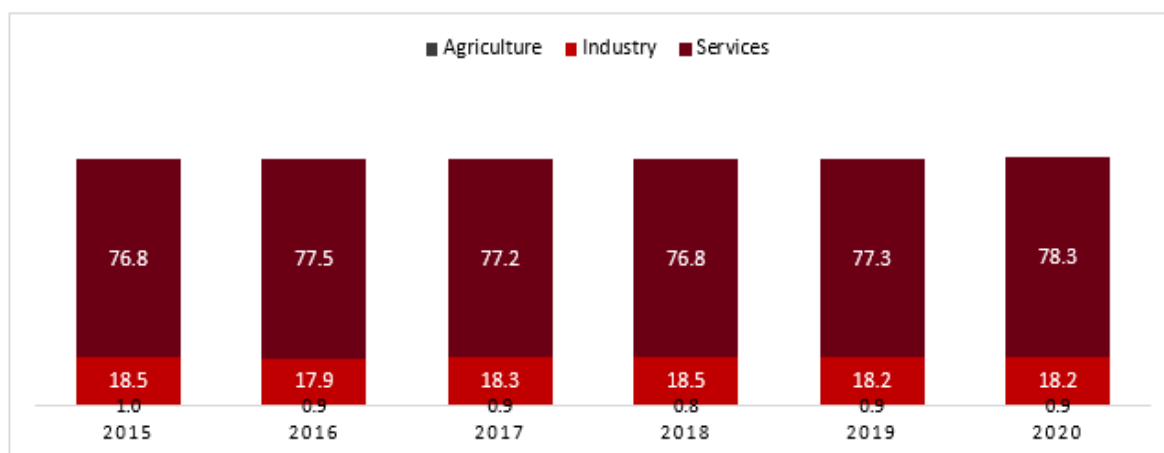

Source: World Bank

### Europe

Growth in ECA is forecast to slow to 3% in 2022—about half the pace in 2021—as tighter macroeconomic policy and recurrent COVID-19 outbreaks, including from Omicron, weigh on demand. Regional growth is forecast to continue to ease in 2023, reaching 2.9%, as fiscal support continues to be withdrawn.

*GDP growth (annual %)*

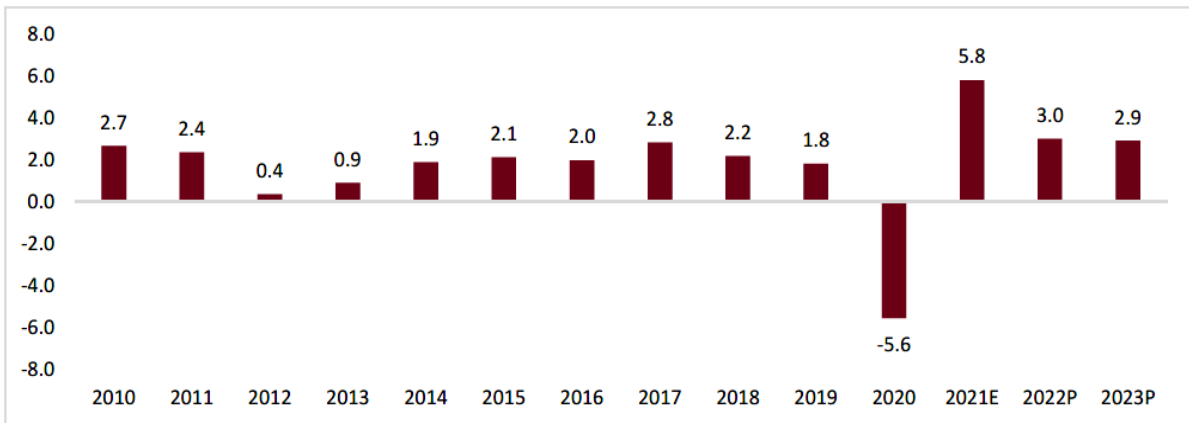

Source: World Bank

Note: The above projections does not include any impact of the on-going Russia & Ukraine crisis

*Share of sector in GVA*

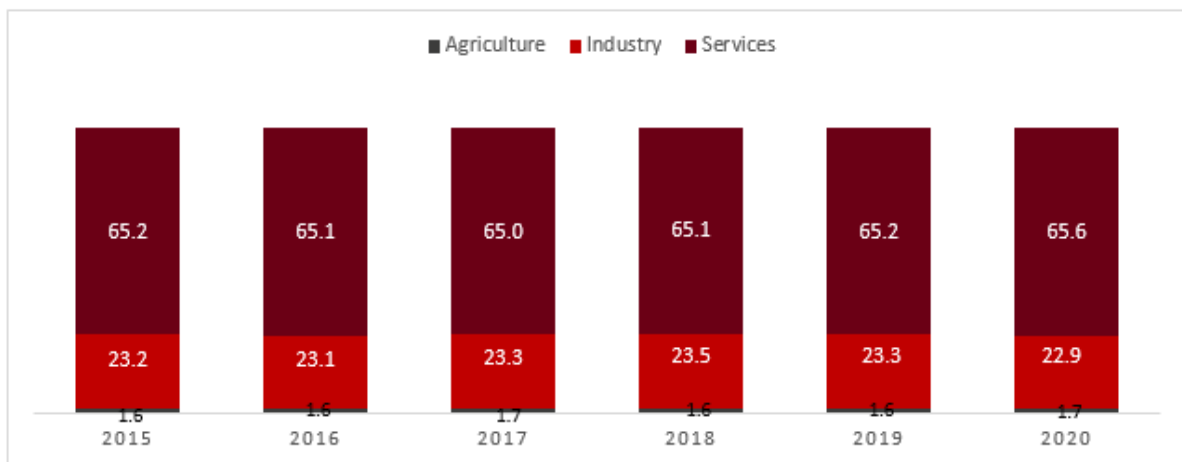

Source: World Bank

**Japan**

GDP growth is set to accelerate from 2021’s mild rebound, with higher household spending on the back of a release of pent-up consumer demand driving the upturn, bolstered by higher capital spending and robust government consumption. The resurgent pandemic and the potential for more stringent restrictions remain key downside risks to the outlook.

*[Remainder of this page intentionally kept blank]*

*GDP growth (annual %)*

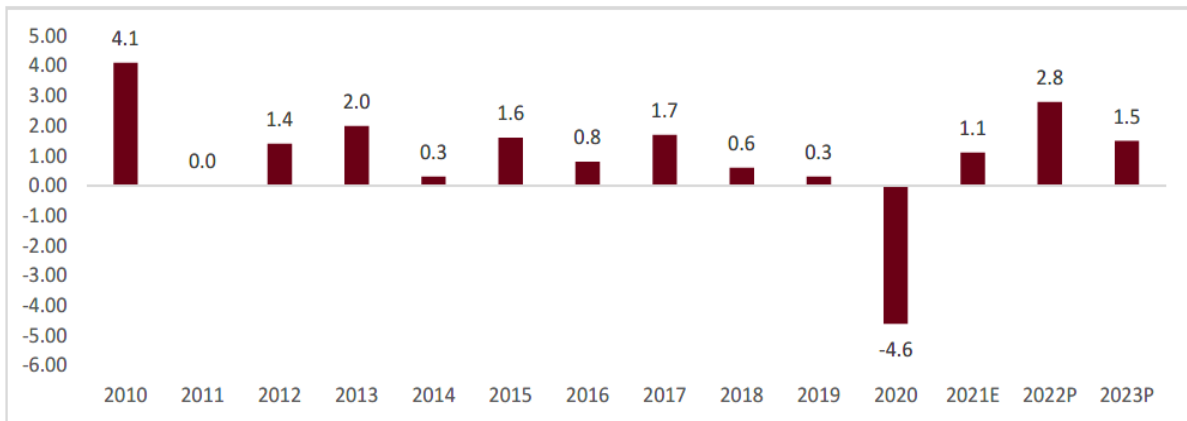

Source: World Bank

Note: The above projections does not include any impact of the on-going Russia & Ukraine crisis

*Share of sector in GVA*

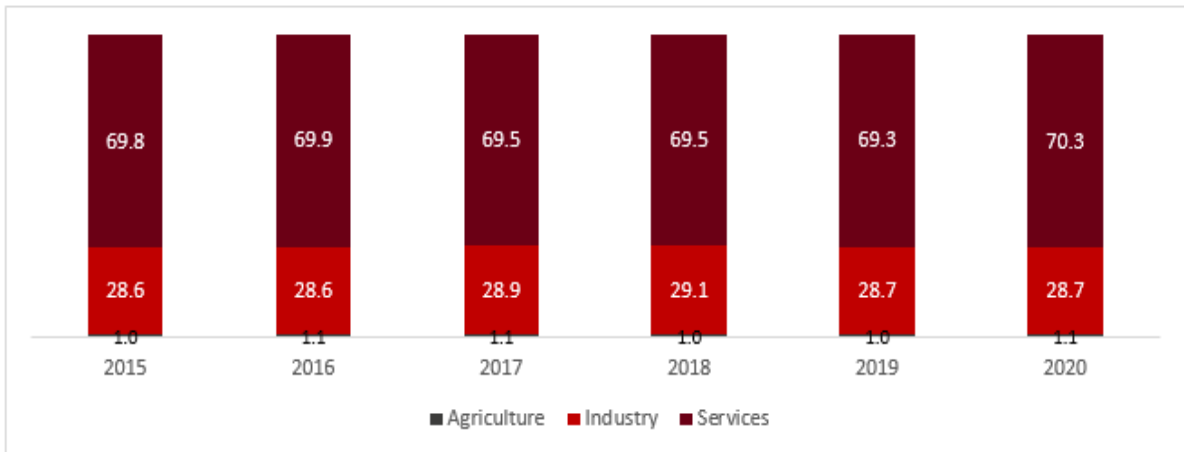

Source: World Bank

**China**

Real GDP growth is expected to reach 8.0% this year – 0.5% points lower than previously projected. Growth is projected to moderate to 5.1% in 2022, closer to its potential, reflecting less favourable base effects, diminished support from exports, and the government’s continued deleveraging efforts.

[Remainder of this page intentionally kept blank]

*GDP growth (annual %)*

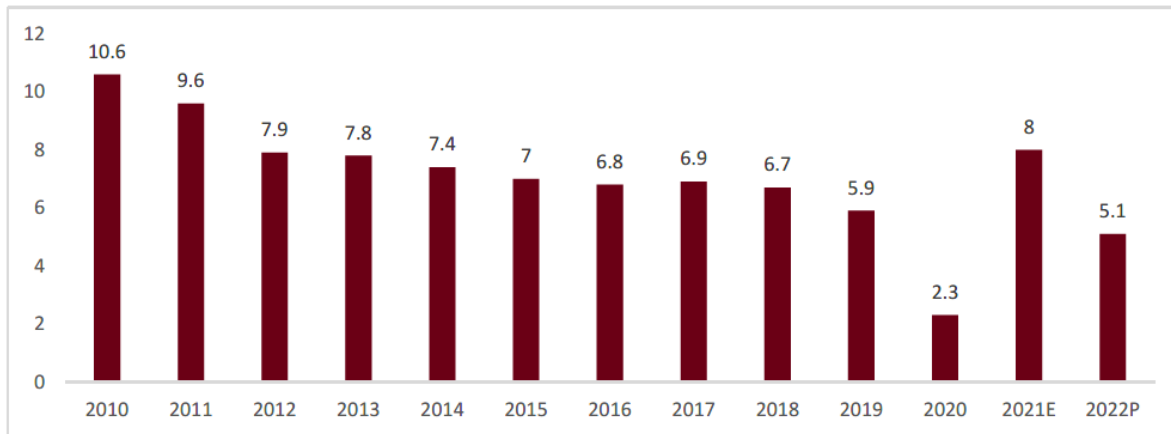

Source: World Bank

Note: The above projections does not include any impact of the on-going Russia & Ukraine crisis

*Share of sector in GVA*

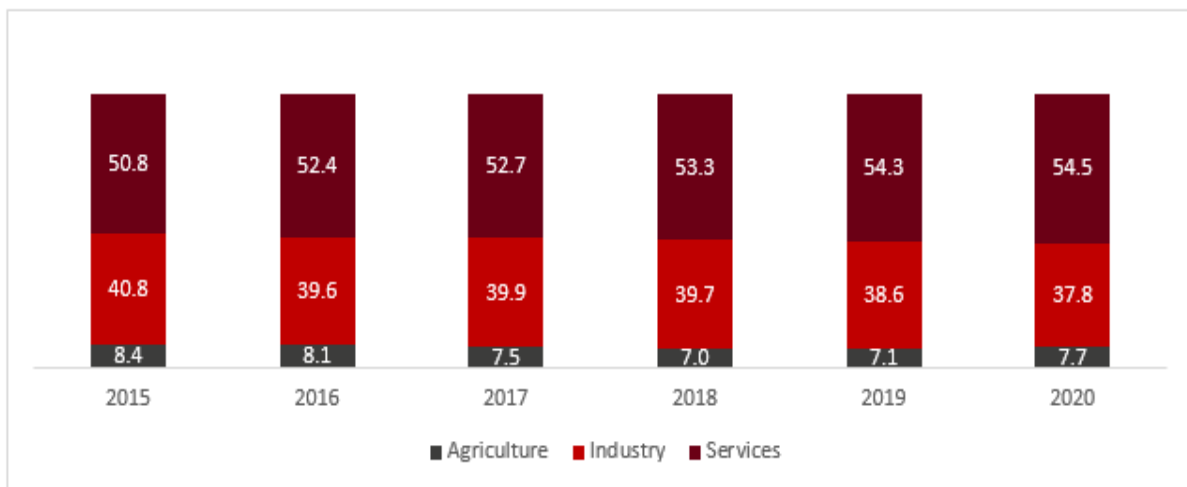

Source: World Bank

**India**

India's GDP to grow 9.2% in Fiscal 2022 and at an average of 6.6% over Fiscals 2022 and 2026. India is likely to emerge as one of the fastest-growing major economies.

Focus on driving investment rather than consumption, which would enhance the economy's productive capacity. In Fiscal 2022, the government has focused on increasing capex at a time when revenue realisation is likely to remain weak.

Rapid urbanisation, rising consumer aspirations and increasing digitisation, coupled with government support in the form of reforms and policies, are expected to support long-term growth. According to the IMF, India is likely to emerge as the fastest-growing country among major global economies in the 2021, Fiscal 2022 and Fiscal 2022 period as well.

Per-capita income is estimated to have grown 3.1% in Fiscal 2020 compared with 5.8% in Fiscal 2019. In Fiscal 2021, per-capita income declined 8.2% owing to GDP contraction amid the pandemic impact.

However, per-capita income is forecast to improve in line with GDP growth. This will be an enabler for domestic

consumption. According to the IMF’s estimates, India’s per-capita income (at constant prices) is expected to increase at 6.7% CAGR over Fiscals 2020 and 2025.

*India is one of the fastest-growing major economies (GDP growth, % on-year)*

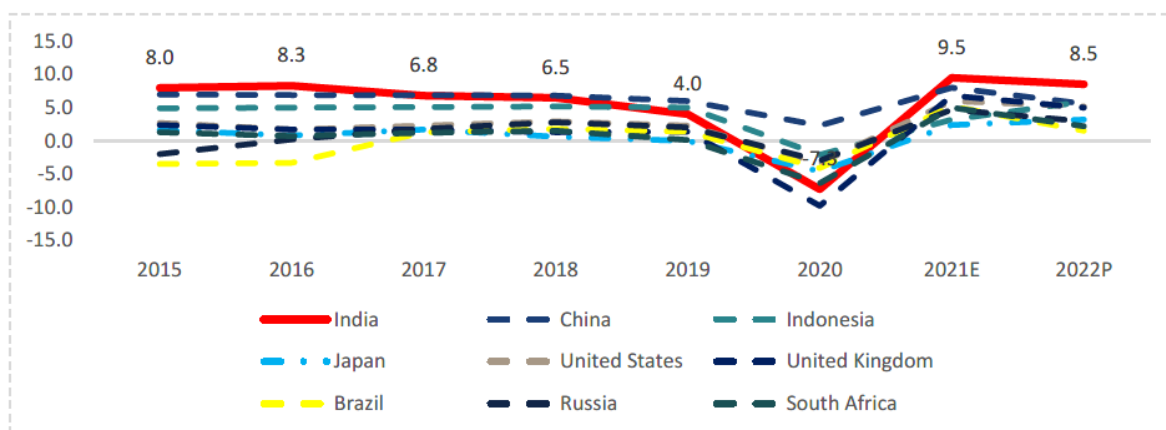

Note: GDP growth is based on constant prices; P: projected

Source: IMF (World Economic Outlook – October 2021 update), IMF data mapper

Note: The above projections does not include any impact of the on-going Russia & Ukraine crisis

*Share of sector in GVA at constant prices*

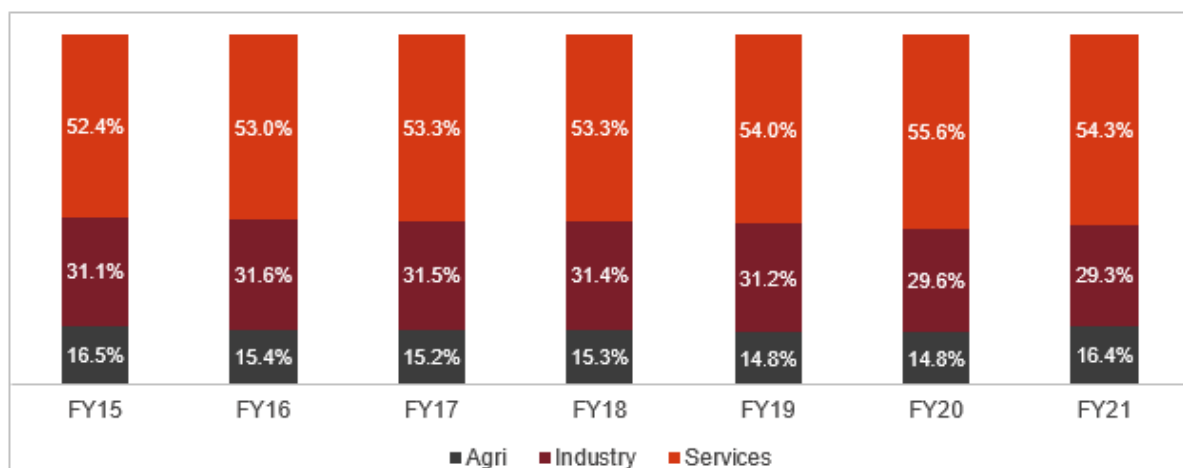

Source: RBI; CRISIL Research

### GLOBAL 3-POINT LINKAGE MARKET: KEY END USER SEGMENTS AND GEOGRAPHIES

The world market for 3-point linkages (“3PL”) is estimated at USD 305 – USD 320 million in 2020 and is expected to grow at nearly 6% - 8% between 2020 and 2025, buoyed by growth in tractor production volumes in North America, India and Europe, steady growth in China and Japan. In 2020, nearly 47% of the global production of tractors takes place in India, followed by 15% in China.

3PL is a system attached to hitch implements to tractors. The three-point linkage most often refers to the way ploughs and other implements are attached to an agricultural tractor. The three points resemble either a triangle, or the letter A. Three point attachments is the simplest and the only statically determinate way of joining two bodies in engineering.

*[Remainder of this page intentionally kept blank]*

*World Tractor Production (2020) – Geography-*

World Tractor Production (2016) – Geography-wise split (1.72 million units)

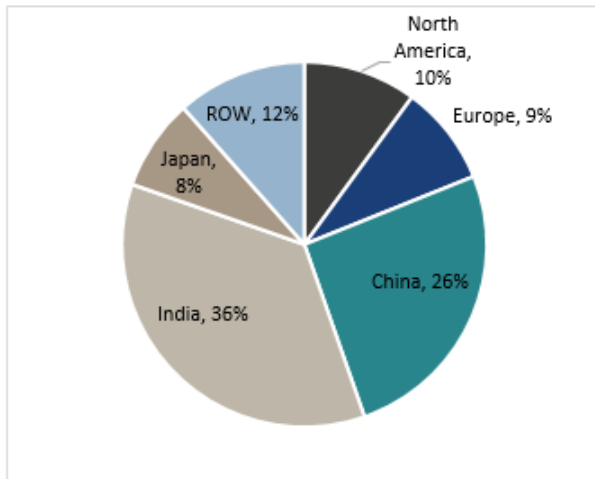

wise split (1.82 million units)

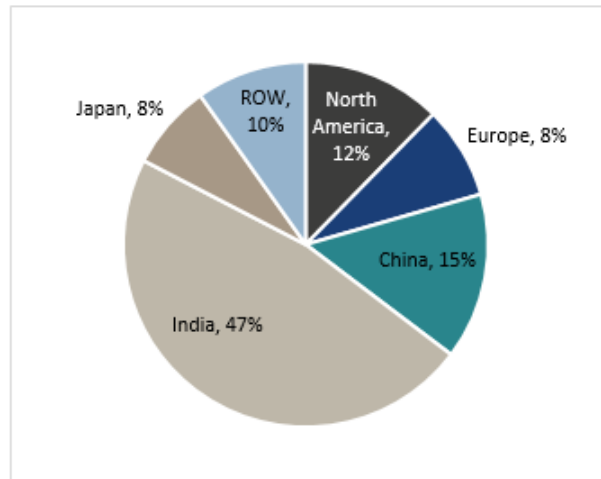

Source: Markets & Markets, Off-highway, CRISIL Research

Note: ROW includes tractor production in all the remaining geographies barring the five major geographies mentioned above

World Tractor Production (2025P) – Geography-wise split (2.19 million units)

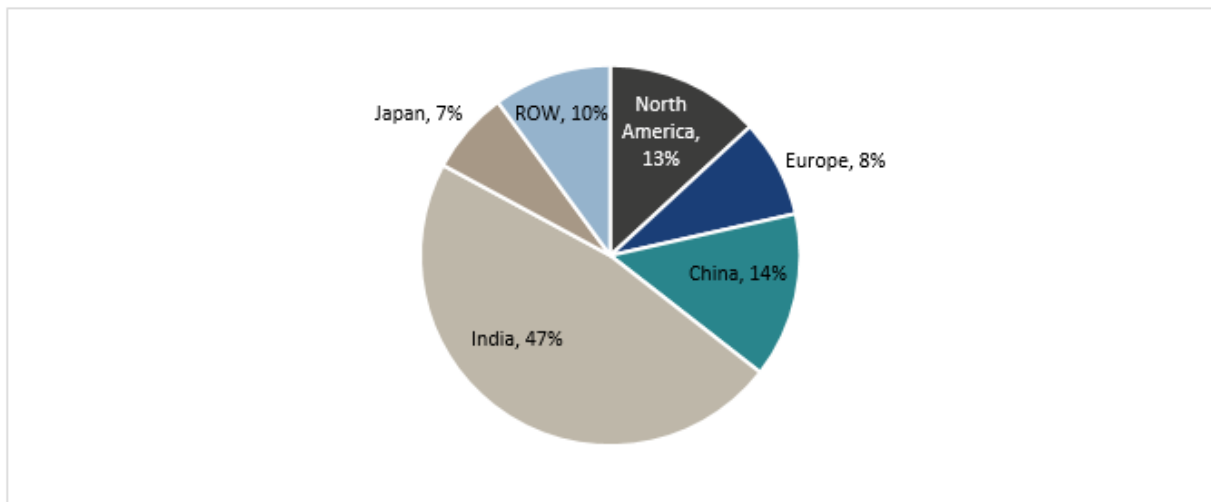

Source: Markets & Markets, Off-highway, CRISIL Research

Note: ROW includes tractor production in all the remaining geographies barring the five major geographies mentioned above

#### Compound Annual Growth Rates – Tractors

CAGR	NORTH AMERICA	EUROPE	JAPAN	CHINA	INDIA	TOTAL
Review (2016-2020)	6.8%	-0.5%	-0.2%	-11.7%	8.8%	1.4%
Outlook (2020-2025)	5.1%	4.1%	2.3%	2.8%	3.8%	3.8%

Source: Industry, CRISIL Research

Note: The above projections does not include any impact of the on-going Russia & Ukraine crisis

#### Market Segmentation based on Horse Power (“HP”)

Of the world tractor demand estimated at 1.8 million units in 2020, approximately 70% is contributed by the less than 60 HP segment, which is driven by India, China, Japan and other developing economies. Whereas remaining

30% of the world tractor demand comes from more than 60 HP segment driven by the economies in Europe and North America.

However, in the world market for 3PL, which is estimated at USD 305 – USD 320 million in 2020, the contribution of more than 60 HP segment rises significantly on the back of higher price of 3PL in higher HP tractors.

### **Regional Demand of Key User Segment – Agricultural Tractor**

#### **North America**

North America is one of the leading farm equipment markets in value terms. It is considered a mature market. Compared to other regions, farmers in North America are wealthier and have adequate resources to invest in the agricultural machinery such as tractors. The US and Canada are key exporters of agricultural products in developing countries such as China, where food demand is relatively high due to high population. As a result, farmers' income in North America is relatively better than other parts of the globe.

North America's agricultural equipment market is expected to register a CAGR of about 5.1% over 2020 – 2025. Tractor sales in North America is a mix of lower and middle HP categories mainly dominated by two-wheel drive tractors. In 2020, approximately 40% of the tractors sold were below 30 HP segment, with tractors above-130 HP contributing only 9% of the North American tractor sales market. During 2016 – 2020, growth of less than 70 HP tractor sales units was higher as compared to other segments.

*North America Tractors Production – Market Segmentation in 2020 (225,000 units)*

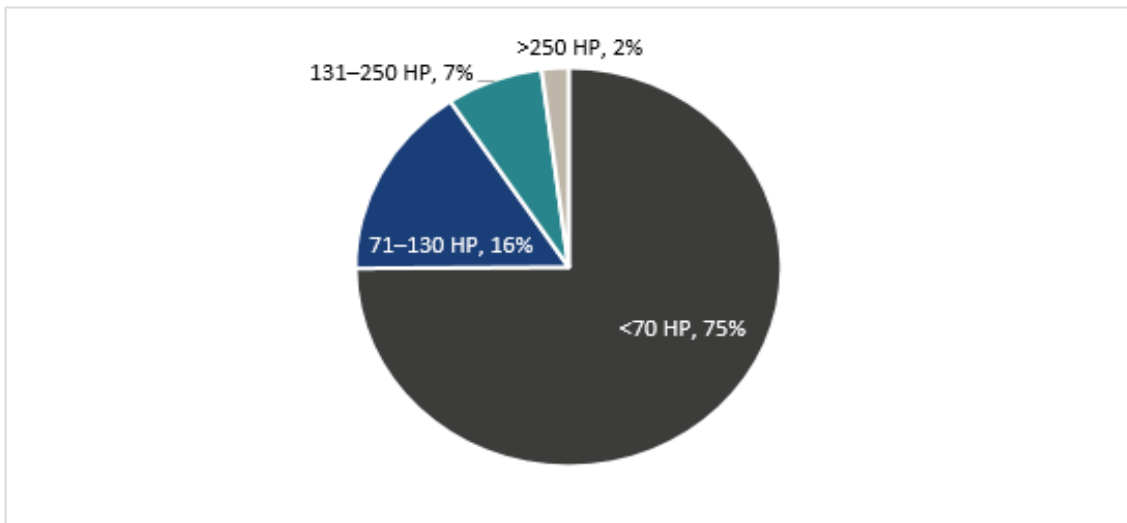

*Source: Off-highway, CRISIL Research*

*[Remainder of this page intentionally kept blank]*



*US Agriculture Equipment Market Share Analysis - By Value (USD 9,038 Million in 2020)*

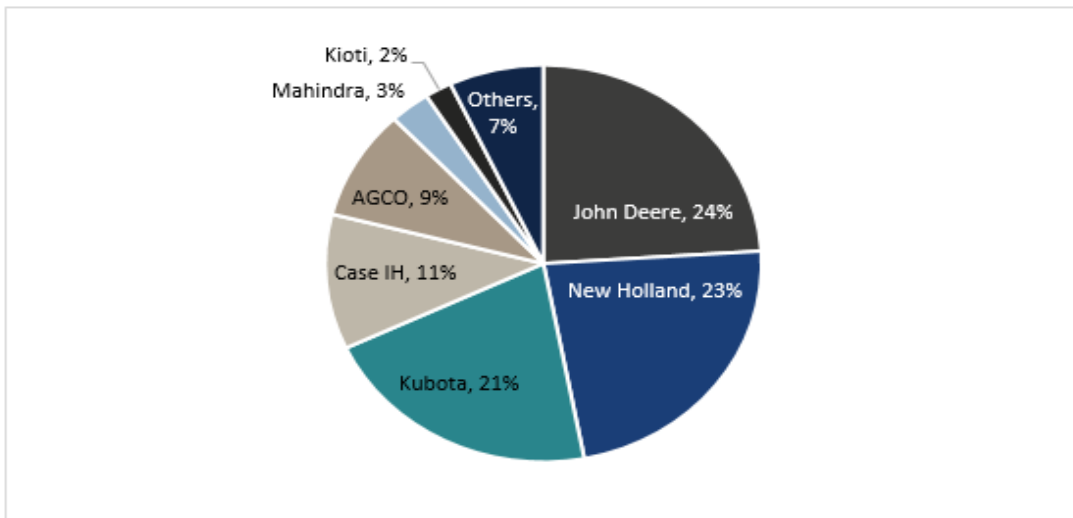

*Source: Markets & Markets, CRISIL Research*

**Key Demand Drivers for Tractors**

- Continued Consolidation of the Farms
- High level of farm mechanisation and labour shortage
- Focus on innovation and new technologies

**Demand Review and Outlook**

Over 2016 – 2020, tractor production in North America recorded a CAGR of 6.8%. Tractor production in 2020 was dominated by less than 70 HP category. It accounted for approx. 75% of the 2020 total production. Further, over 70 HP tractors and 4 Wheel Drive (“4WD”) tractors accounted for 23% and 2%, respectively of 2020 total production.

*North America Tractor Production Volumes (units in thousands)*

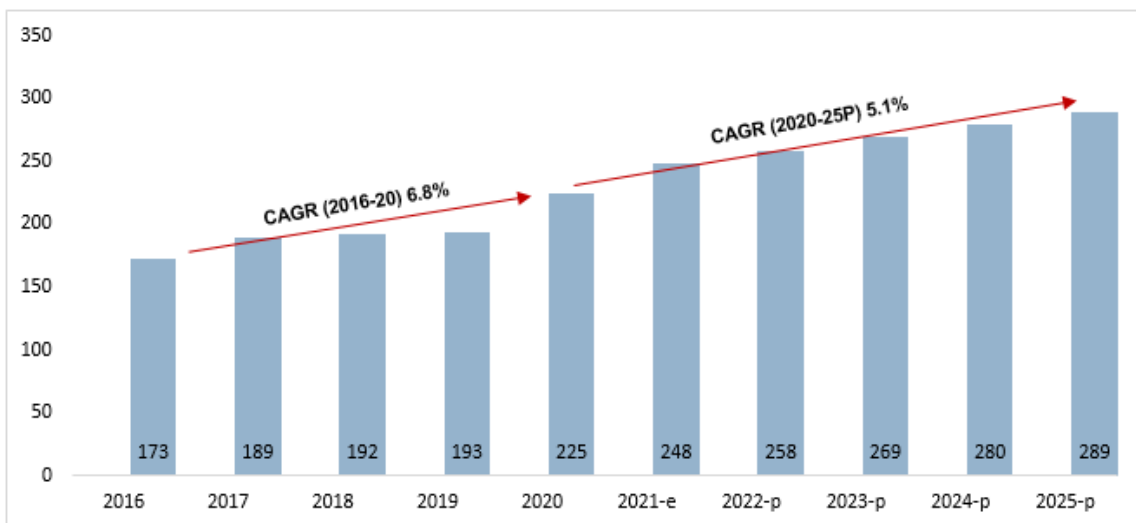

*Source: Off-highway, CRISIL Research*

**Europe**

Europe is one of the major producers of agricultural products.

According to the European Committee of Farm Machinery Manufacturer’s Associations (CEMA), the European agricultural machinery market is currently growing and corresponds to the past peak level witnessed in 2012. Key factors driving the market include: (1) improved productivity through mechanisation, (2) optimised supply chain, and (3) labour shortage. Further, innovative technologies and precision farming are also shaping the positive market outlook for the market.

Majority of the tractors sold in Europe are over 70 HP. The European tractor market is highly competitive with key players competing in terms of cost, brand appeal, horsepower, utility, and economic efficiency.

*Germany Agriculture Equipment Market Share Analysis - By Value (USD 2,834 Million in 2020)*

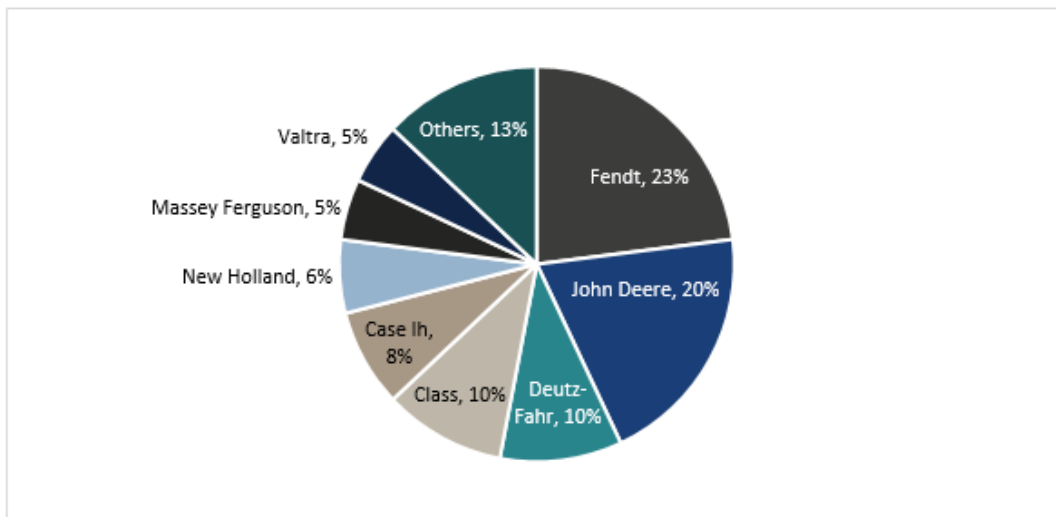

Source: Markets & Markets, CRISIL Research

France

*Agriculture Equipment Market Share Analysis - By Value (USD 2,377 Million in 2020)*

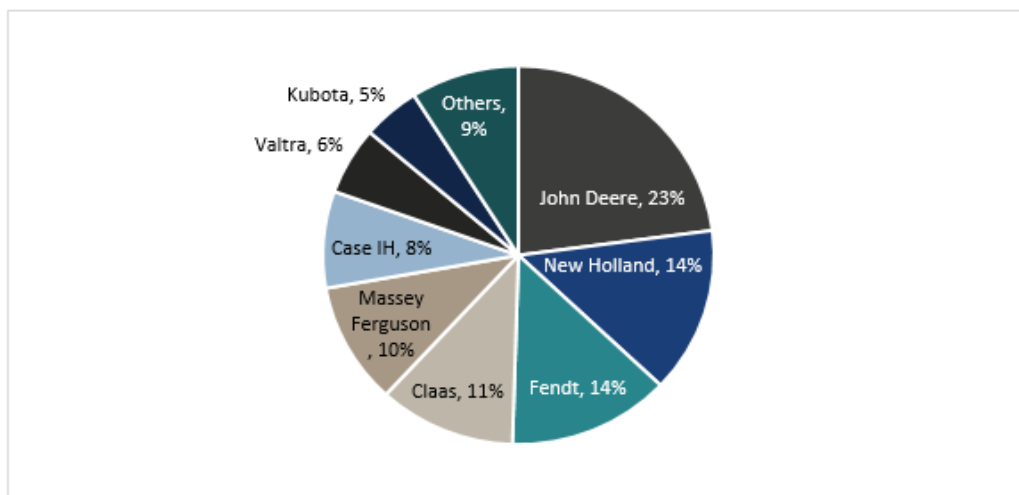

Source: Market & Markets, CRISIL Research

[Remainder of this page intentionally kept blank]

Italy Tractor Market Share by Manufacturer - By Value (USD 1,202 Million in 2020)

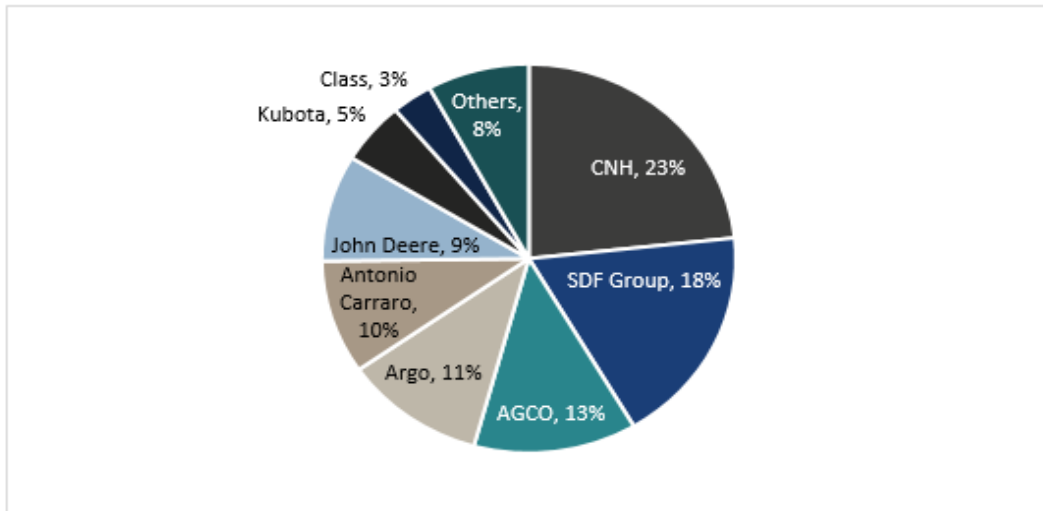

Source: Ministry of Transport/Trattori, CRISIL Research

### Key Demand Drivers for Tractors

- Continued shift towards large farms
- Technological innovation to develop high efficiency products
- Higher food consumption and adoption of organic products

### Demand Review and Outlook

During 2016 – 2020, tractor production in Europe recorded a CAGR of -0.5%. Tractor production in 2020 is dominated by over 70 HP category. It accounted for about 76% of the total production in 2020. However, 4WD tractor production is not popular in Europe.

Europe Production Volumes of Tractors (units in thousands)

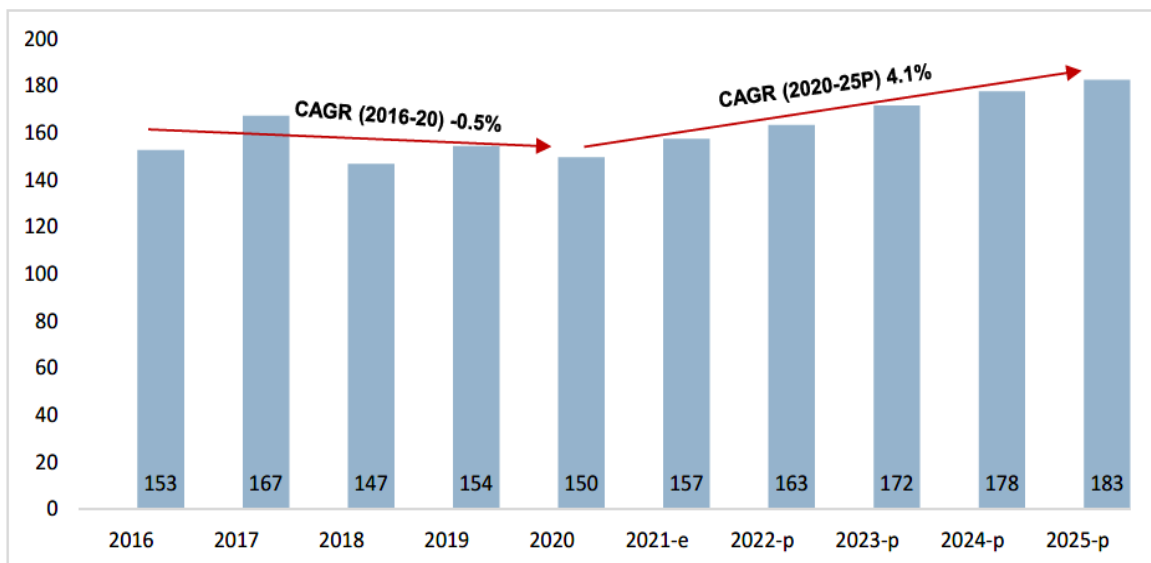

Source: Markets & Markets, CRISIL Research

### Japan

Japan's agricultural sector is relatively small and slowly contracting. Over the past decade, Japan has reduced its

support to agriculture, but more recently the change in support levels has been moderate. Support to producers remains high as a share on gross farm receipts (41% in 2017-19) and is almost 2.4 times above the OECD average. The total support estimate to agriculture represented 0.9% of Japan’s GDP in 2017-19, most of which went to direct support to producers. Farmers typically use terrace system to farm in small areas. This system has helped Japan to achieve world-leading yield per hectare.

In Japan, tractor sales are a mix of lower and middle HP categories mainly dominated by two-wheel drive tractors. In 2020, approximately 85% of the tractors sold were below 30 HP segment, with tractors above-70 HP contributing only 4% of the tractor sales market.

*Japan Tractors Production – Market Segmentation (138,000 units in 2020)*

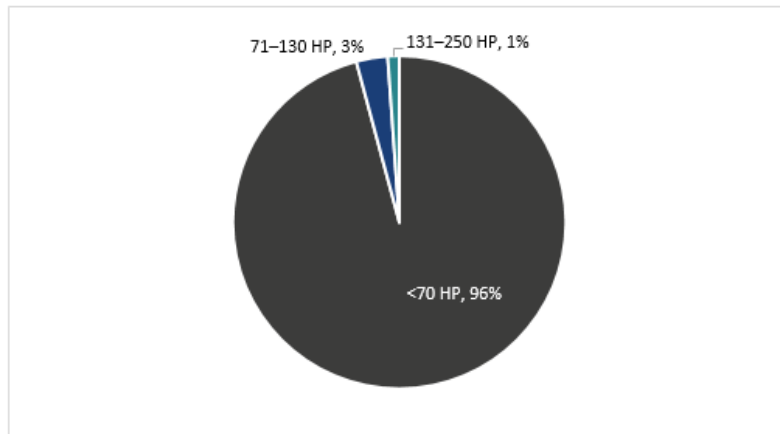

*Source: Off-highway, CRISIL Research*

Key tractor companies operating in Japan in terms of popularity include the following:

Tractor Brand
Kubota Corporation
Yanmar Holdings Co. Ltd
ISEKI & CO., LTD.
Mitsubishi Mahindra Agricultural Machinery CO., LTD.
John Deere (Deere & Company)
New Holland HFT Japan
Mahindra & Mahindra
Agrale
Massey Ferguson
Kukje Machinery Company Limited

*Source: Markets & Markets, CRISIL Research*

### Key Demand Drivers for Tractors

- Aging population and labour shortage
- Focus on innovation and adoption of new technologies

### Demand Review and Outlook

Over 2016 – 2020, tractor production recorded a CAGR of -0.2%. Tractor production in 2020 is dominated by less than 60 HP category. Further, production of over 60 HP tractors and 4WD tractors is quite limited in Japan.

*[Remainder of this page intentionally kept blank]*

*Japan Production Volumes of Tractor (units in thousands)*

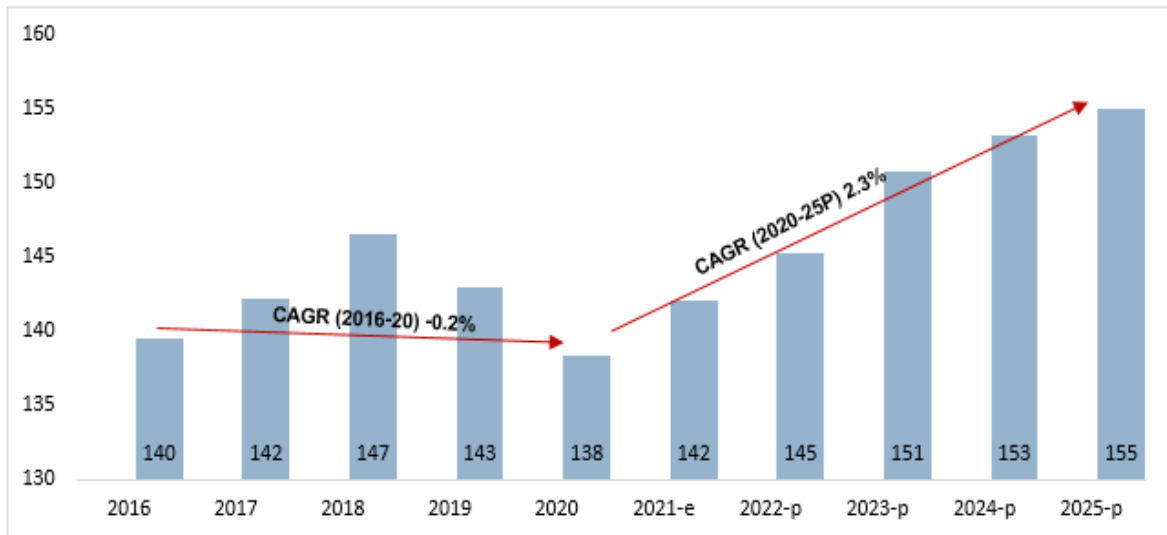

Source: *Off-highway, CRISIL Research*

**China**

China is the world’s second-largest economy and is home to one-fifth of the global population. China’s arable land, which represents 10% of the total arable land in the world, supports over 20% of the world’s population. Of this approximately 1.4 million square kilometers of arable land, only about 1.2% (116,580 square kilometers) permanently supports crops and 525,800 square kilometers are irrigated.

China is now the world’s largest agricultural importer, surpassing both the European Union and the United States in 2019 with imports totalling USD 133.1 billion.

Tractor sales in China is dominated by less than 70 HP tractors. In 2020, approximately 75% of the tractors sold were below 70 HP segment. Tractors above 130 HP contributed only 7% of the China tractor market. High HP tractors and combines are widely used in Northern China as farm size are larger in the region. However, such tractors are not suitable for southern regions as farm size is small.

*China Tractors Production – Market Segmentation (269,000 units in 2020)*

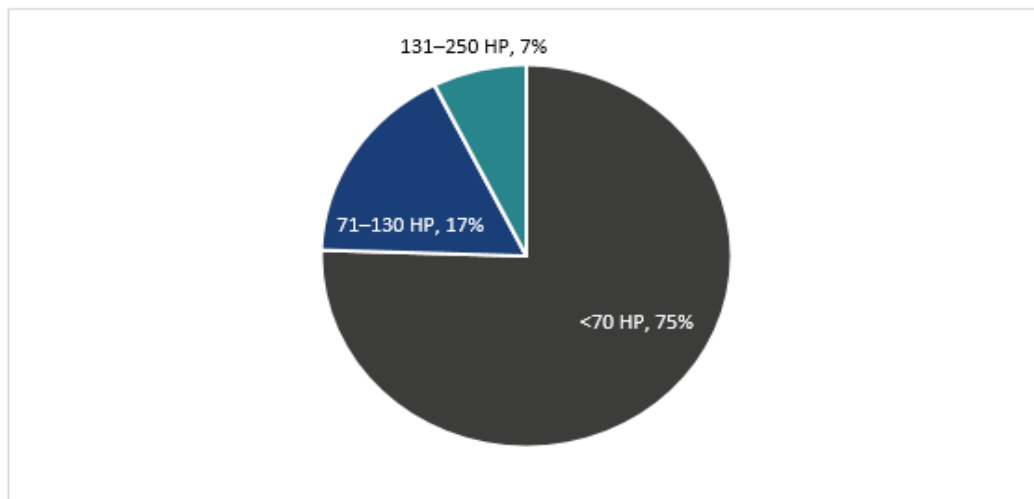

Source: *Off-highway, CRISIL Research*

*China Agriculture Equipment Market Share Analysis - By Value (USD 2,575 Million in 2020)*

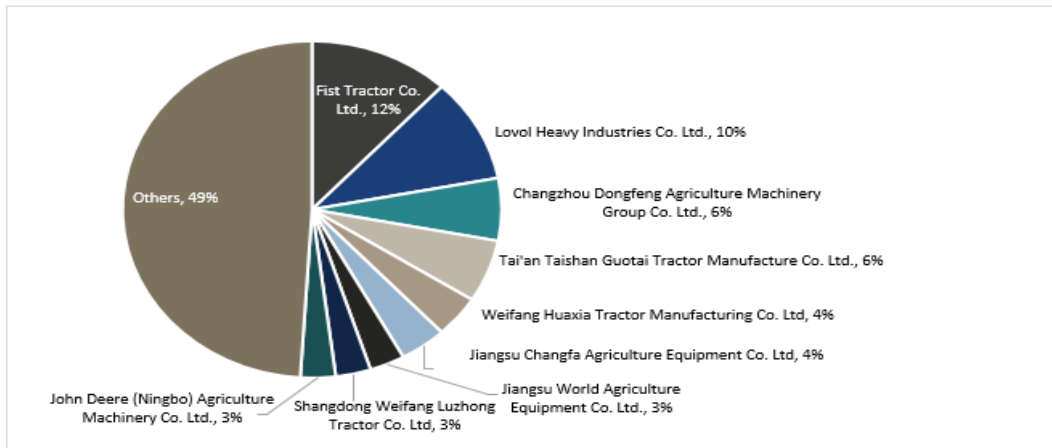

Source: Markets & Markets, CRISIL Research

**Key Demand Drivers for Tractors**

- Subsidies to support higher level of mechanisation
- Urbanisation and decline in agriculture workforce
- Farm consolidation on the rise

**Demand Review and Outlook**

During 2016 – 2020, China’s tractor production registered annual decline of 11.7%. The less than 70 HP tractors dominate the tractor production in China. It accounted for 75% share in 2020. However, 4WD tractor production is not popular in China.

*China Production Volumes of Tractor (units in thousands)*

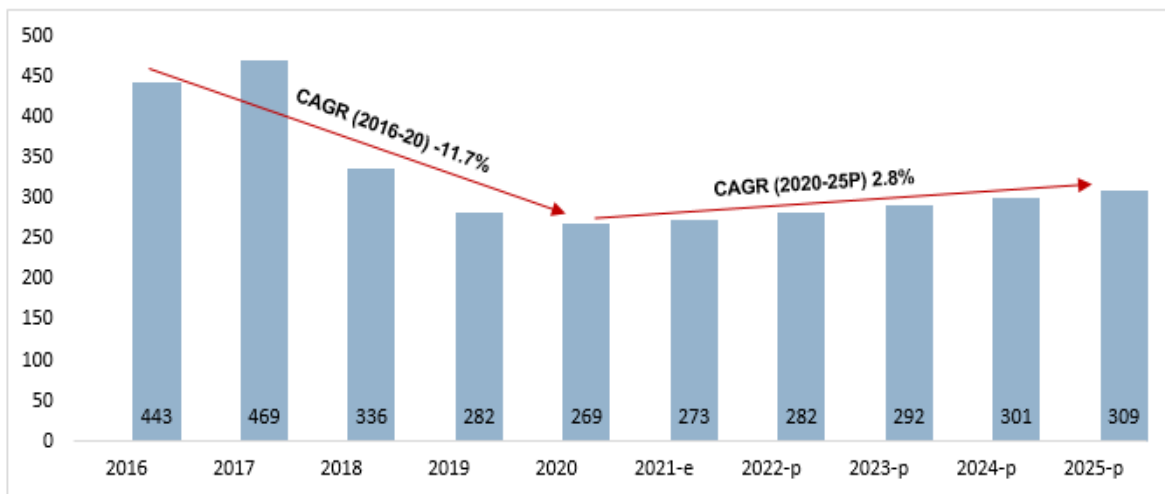

Note: Production volumes does not include <30HP segment tractor units as data was NA from trusted sources for the same

Source: Off-highway, CRISIL Research

**India**

For a long time since Independence, the market was dominated by mid-sized tractors with engine capacity of 30HP -40 HP. But it has diversified in recent years, which is evident in the rising demand for both bigger (over 50 HP) and smaller (below 20 HP) tractors.

With growing need for greater precision in farm operations, especially in areas where intensive multi-crop farming is performed, demand for tractors of different sizes and utility values is bound to increase.

Average size of tractors in India is 35 HP, which is much smaller than in US and Europe. In last five years, we can see a clear trend of farmers moving towards greater than 51 HP segment. As of Fiscal 2020, This segment grew by more than 75% as compared to Fiscal 2015. 41-50 HP segment share has also been increasing marginally in the past five years. However, 31-40 HP segment's share has been declining in the past five years.

Another factor driving demand for higher HP tractors is upgradation by farmers to allow mechanisation with rotary tillers and similar equipment. Significant demand had been generated by applications in haulage and construction.

Mechanisation will be further fuelled by increasing shortage of labour. A new trend is evolving – tractors of less than 15 HP are being launched by manufacturers for farming smaller plots. Within segments, the domestic tractors market is dominated by 31-40 HP and 41-50 HP segments.

*Proportion of tractor sales in India (862,000 units in 2020)*

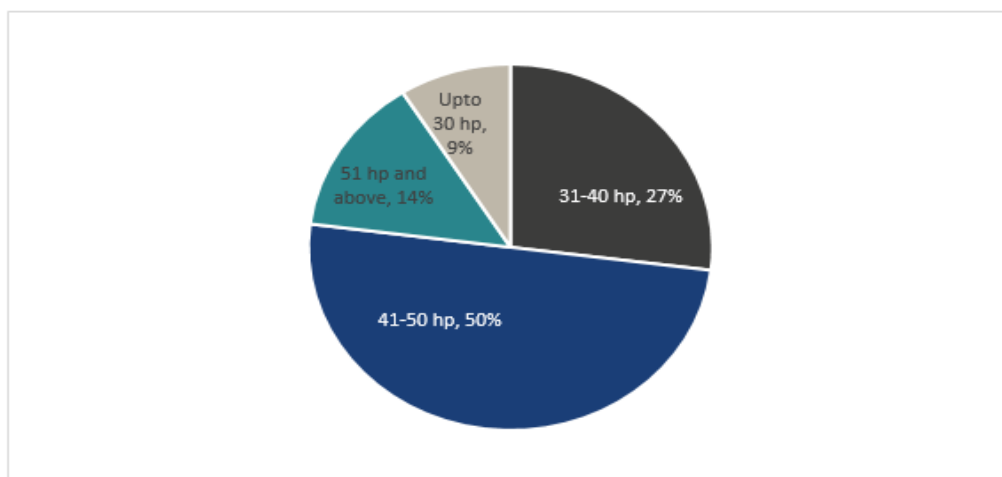

*Source: TMA, CRISIL Research*

*Indian tractor market share (862,000 units in 2020)*

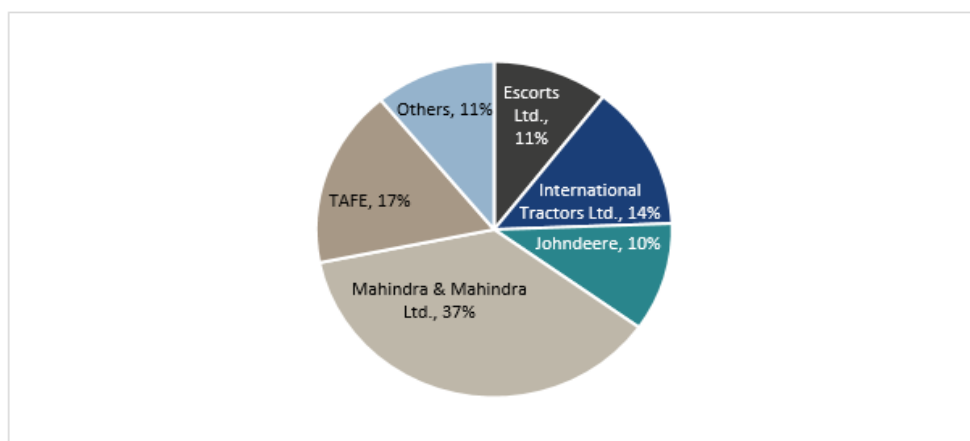

*Source: TMA, Crisil Research*

### **Key Demand Drivers for Tractors**

Tractor demand is mainly driven by farmers' ability to purchase tractors and is affected, both directly and indirectly, by a number of factors:

- Irrigation intensity and monsoons
- Small landholding limits mechanisation advantages
- Availability of credit on the rise
- Minimum support prices of food grains
- Cropping pattern
- Increase in cash crop production
- Nature of soil
- Crop mix
- Replacement demand
- Purpose of use
- Resale price of tractors

## Demand Review and Outlook

In 2020, tractor production grew by 1%, owing to two consecutive years of near-normal monsoon, government support in various states on account of COVID-19 impact.

Farm incomes were marginally impacted on the back of lower prices for pulses and coarse cereals. However, a record high food-grain production led to higher output in major states, improving farm income for paddy, wheat and sugarcane growers mainly, coupled with increase in government intervention across states, improving tractor demand.

*India's tractor production volumes (units in thousands)*

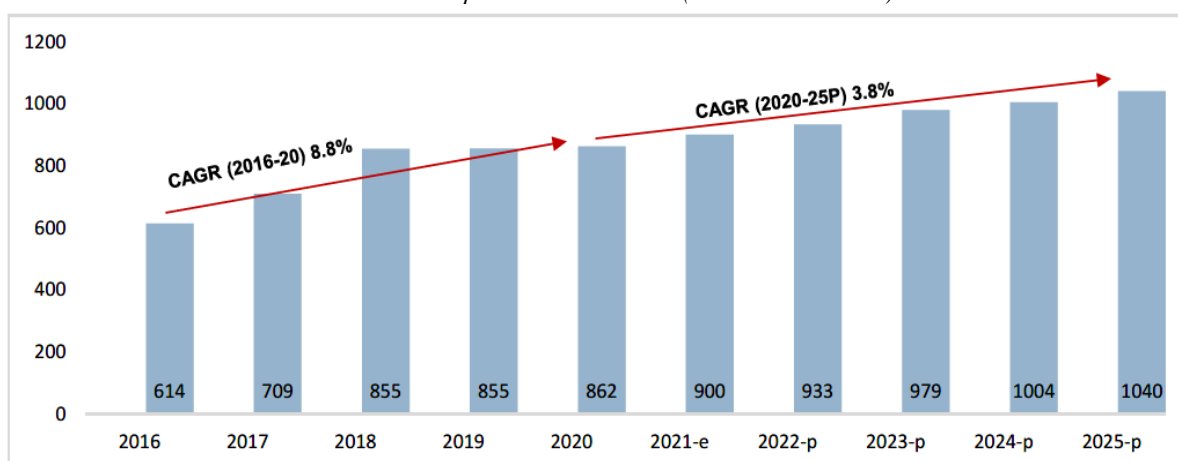

Source: Off-highway, Crisil Research

Tractor production is projected to grow 3.8% in 2021, with normal monsoon expected to result in healthy growth for the cropping cycle and improved farmer sentiment. Government's increasing focus on rural activities has significantly boosted agricultural demand for tractors. However, rising tractor prices amid price hikes taken by OEMs due to rising commodity inflation; higher inventory at dealer's end to impact sentiments in the coming year. Credit availability continues to be stable with NBFCs strengthening their focus on tractor financing.

## Market Size and Outlook by Region

### World Market

The world market for 3PL is estimated at USD 305 – USD 320 million in 2020, grew at a CAGR of around 2% during 2016 – 2020.

Europe, contributing nearly 8% of the world tractor volume, is one of the key demand geographies for 3PL - contributing almost 26% of the world demand for such parts in value.

India and China together account for around 62% of world tractor production but generate an estimated demand of only 38% for 3PL by value. This is primarily due to



- higher ratio of lower HP tractors in the total population
- lower prices of 3PL in these regions

North America being one of the most mature tractor markets contributes around 12% of world tractor demand and is estimated to contribute around 19% of the total demand for 3PL in the world.

*World 3PL Market (USD 375 million – USD 395 million) in 2016*

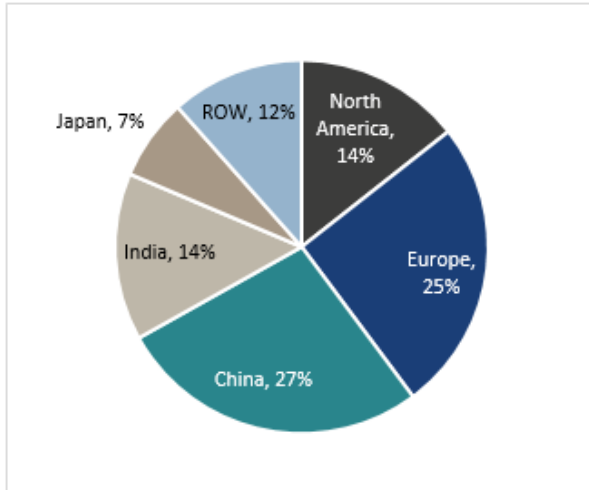

*Source: Off-highway, CRISIL Research*

*World 3PL Market (USD 305 million - USD 320 million) in 2020*

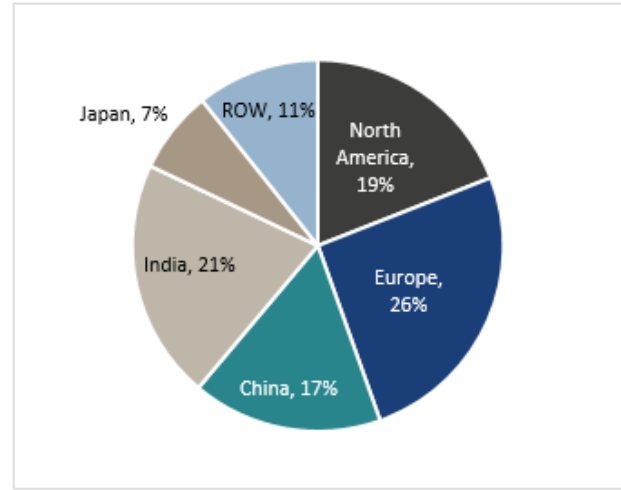

*Source: Off-highway, CRISIL Research*

*Note: ROW includes tractor production in all the remaining geographies barring the five major geographies mentioned above*

*World 3PL Market (USD 430 million – USD 450 million) in 2025P*

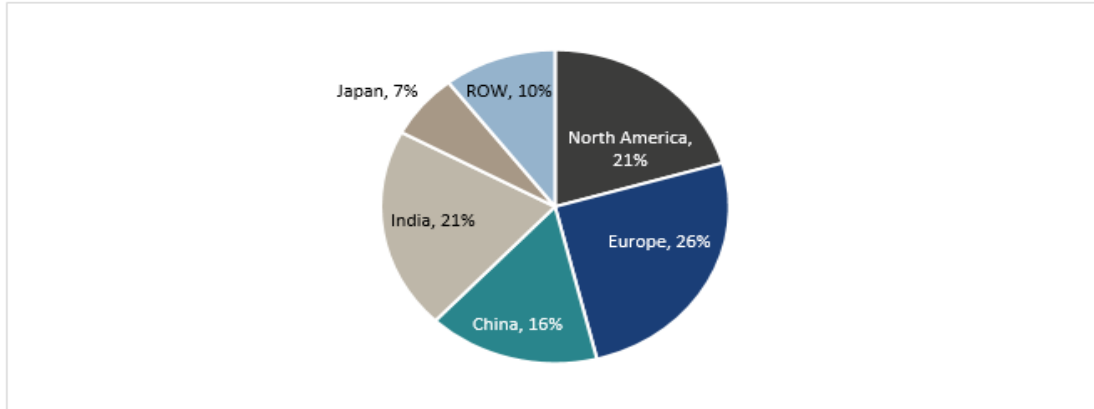

*Source: Off-highway, CRISIL Research*

*Note: ROW includes tractor production in all the remaining geographies barring the five major geographies mentioned above*

The 3PL most often refers to the way ploughs and other implements are attached to an agricultural tractor. The three points resemble either a triangle, or the letter A. Three point attachments are the simplest and the only statically determinate way of joining two bodies in engineering.

The 3PL systems consist of different assemblies that are attached to an agricultural tractor. It forms a group of assemblies allowing attaching an implement like a plough to the tractor at three coupling points forming a triangle.

It connects the implement in a manner to the tractor that the tractor and implement becomes one unit allowing the tractor to operate the implement. The 3PL transfers the entire load which can be a multiple of the implement weight between the tractors and implement.



The hitch lifting arms are powered by the tractor's own hydraulic system. The hydraulic system is controlled by the operator, and usually a variety of settings are available. A draft control mechanism is present in all three-point linkage systems.

*Compound Annual Growth Rates (CAGR) – 3PL*

CAGR	NORTH AMERICA	EUROPE	JAPAN	CHINA	INDIA	TOTAL
<b>Review (2016-2020)</b>	6.8%	-0.5%	-0.2%	-11.7%	8.8%	1.4%
<b>Outlook (2020-2025)</b>	5.1%	4.1%	2.3%	2.8%	3.8%	3.8%

Source: Industry, CRISIL Research

Note: The above projections does not include any impact of the on-going Russia & Ukraine crisis

**Geography-Wise 3PL market**

*North America*

*North America 3PL Market Value in (USD million)*

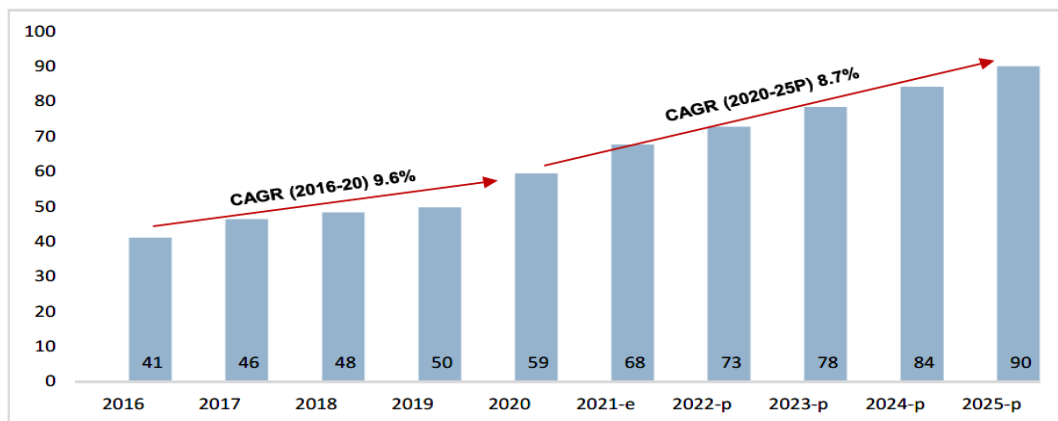

Source: Off-highway, CRISIL Research

**Outlook**

During 2020 – 2025, tractor production in North America is expected to record a CAGR of 5.1% to reach 289,000 units in 2025. Expected growth in the tractor production due to consolidation of farms, technological innovation and labor shortage is estimated to increase the demand of 3PL. As a result, 3PL market in North America is expected to increase at a CAGR of 8.7% to USD 90 million in 2025.

## Europe

Europe 3PL Market Value in (USD million)

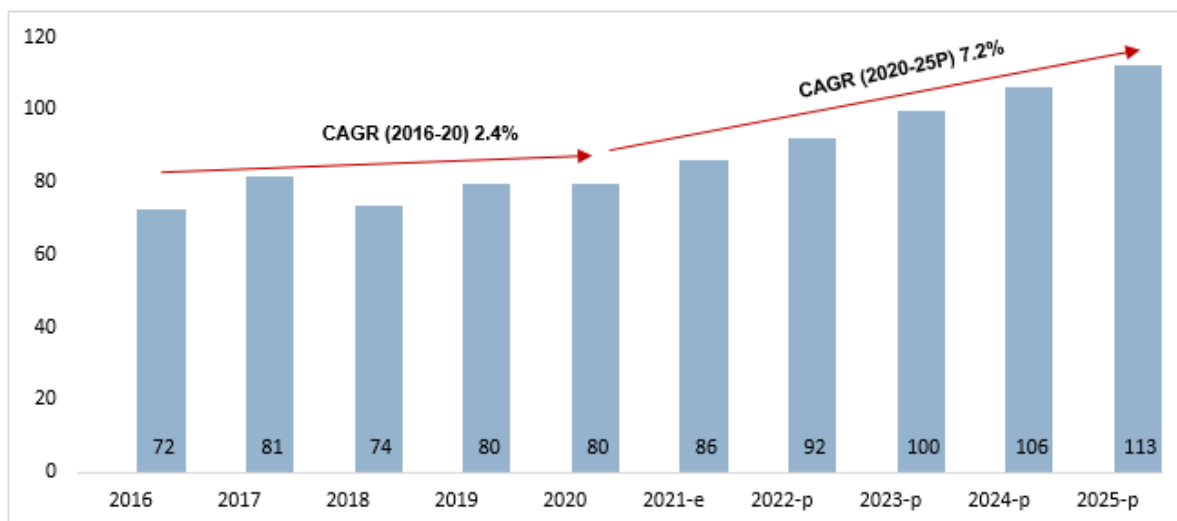

Source: Off-highway, CRISIL Research

## Outlook

Over 2020 – 2025, tractor production in Europe is expected to register a CAGR of 4.1% to reach 183,000 units in 2025. Expected growth in the tractor production due to shift towards larger farms, technological innovation, and increase in the income of farmers will drive the demand of 3PL. As a result, 3PL market in Europe is expected to increase at a CAGR of 7.2% to USD 113 million in 2025.

## Japan

Japan 3PL Market Value in (USD million)

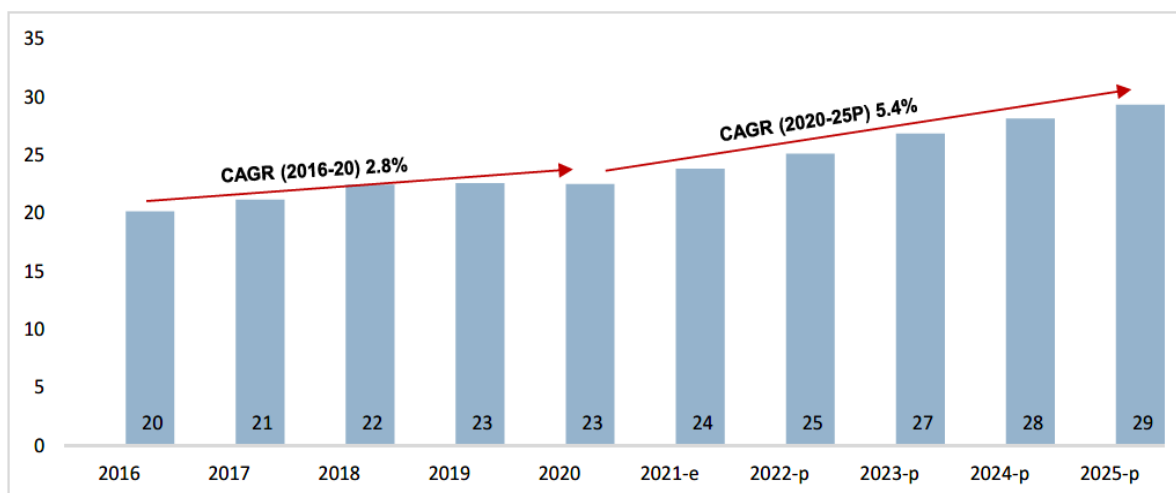

Source: Off-highway, CRISIL Research

## Outlook

Over 2020 – 2025, tractor production in Japan is expected to register an annual growth of 2.4% to 155,000 units in 2025. The growth in Japan will be slower compared to the US and Europe. However, factors such as labor shortage, aging population, and technological innovation will impact the tractor market. During the same period, 3PL market in Japan is expected to increase at a CAGR of 5.4% to USD 29 million in 2025.

## China

China 3PL Market Value in (USD million)

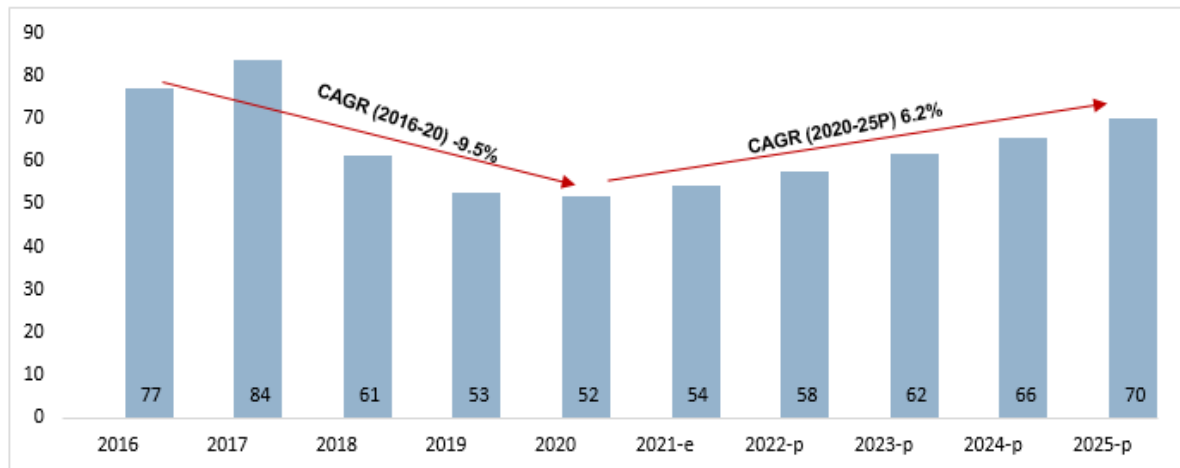

Source: Off-highway, CRISIL Research

## Outlook

During 2020 – 2025, China’s tractor production is expected to record a CAGR of 2.8% to reach 309,000 units in 2025. Expected growth in the tractor production due to government subsidies, shortage of labor due to urbanisation, and farm consolidation will increase the demand of 3PL. As a result, 3PL market in China is expected to increase at a CAGR of 6.2% to USD 70 million in 2025.

## India

The 3PL industry has surged on the back of a strong growth in overall tractor production and increase in average price of 3PL parts in the market.

India’s 3PL market value (USD million)

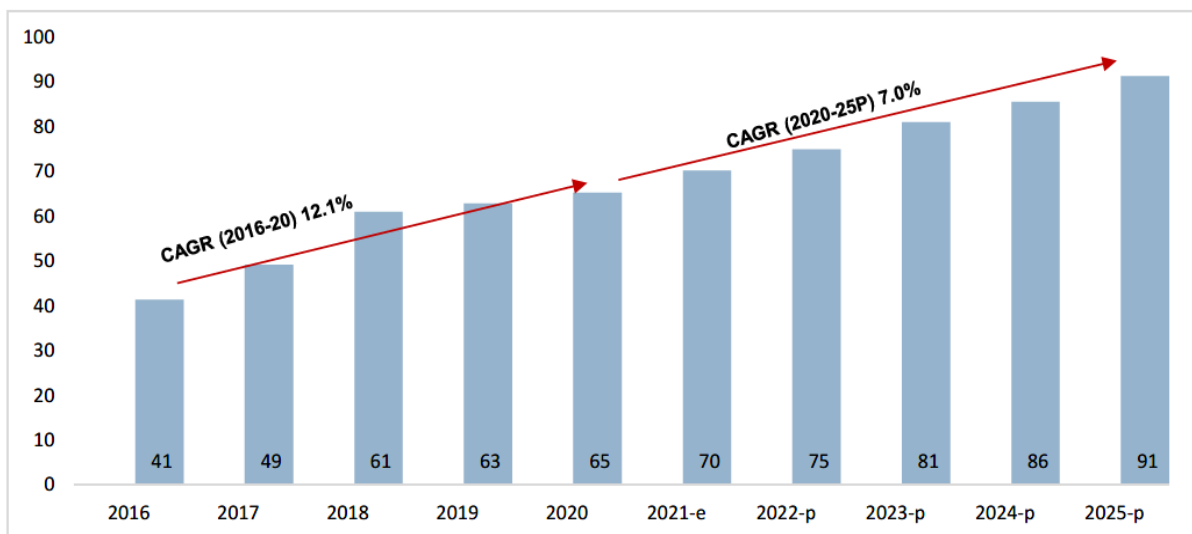

Source: Off-highway, Crisil Research

## Outlook

Between 2020 and 2025, with increasing mechanisation in India’s agriculture sector, supply of tractors is expected to increase at CAGR of around 4%, coupled with rise in average price of 3PL parts in the market, due to hike in

raw material cost. This will lift demand for 3PL at CAGR of around 7%.

Precision components are highly precise machinery parts manufactured based on custom specifications of customers, used for industrial and machine-based companies in different applications, like CNC turning. The precision components generally produced with a diversity of materials including metals such as stainless steel, brass, copper, bronze, aluminium, steel, titanium and specialized alloys, to ensure stability and functions of engineering. They are a group of products that are components requiring stringent material and manufacturing specifications and controls. These include among others, precision machined components, for example, pins, bushes used in articulated joints across the construction, forestry and mining equipment.

The structure of precision machined product (“PMP”) industry is fragmented in few geographies, whereas organised in other geographies. PMP manufacturers are generally private players. Therefore, it is difficult in mapping the industry players and evaluate competitive benchmarking.

*Worldwide PMP for articulated joints (AJ) Market (USD 321 million) in 2016*

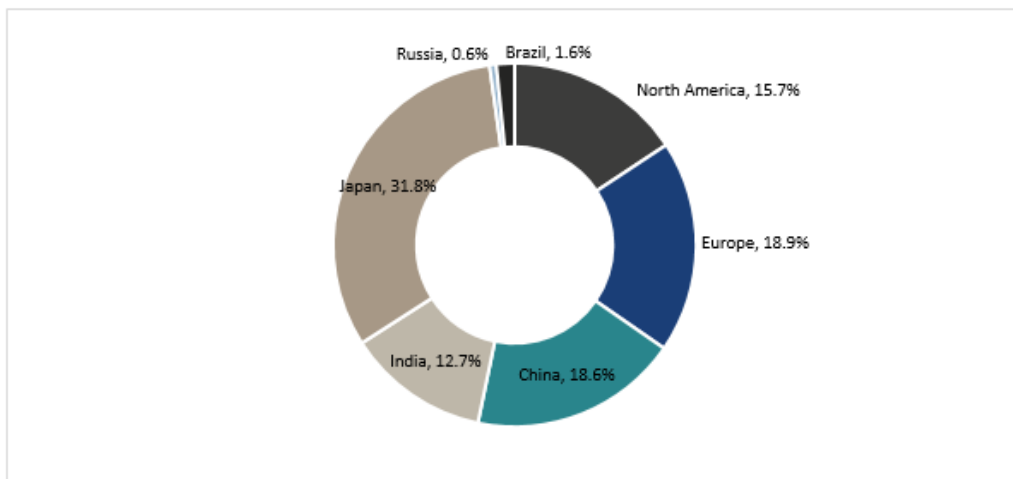

*SOURCE: CRISIL Research*

*Worldwide PMP for articulated joints (AJ) Market (USD 520 million) in 2020*

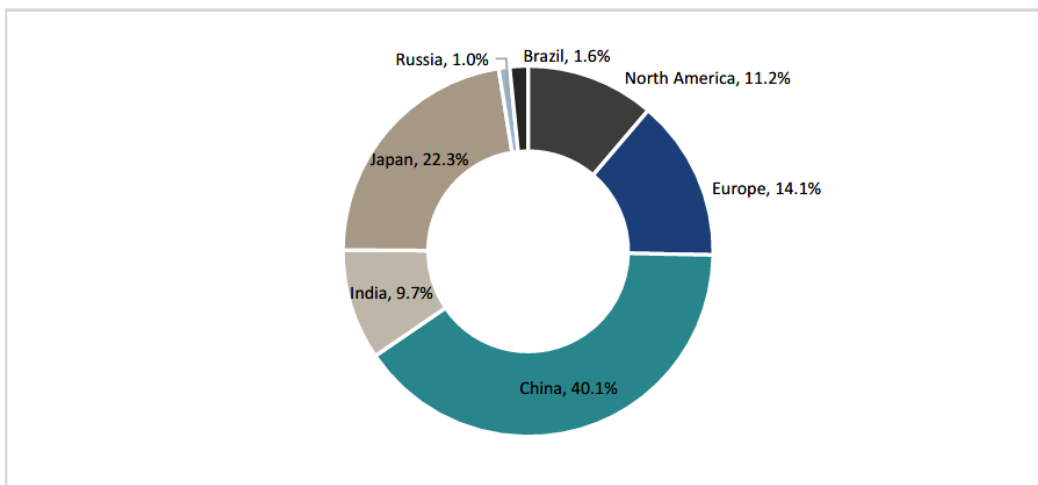

*Source: CRISIL Research*

*Worldwide PMP for articulated joints (AJ) Market (USD 762 million) in 2025P*

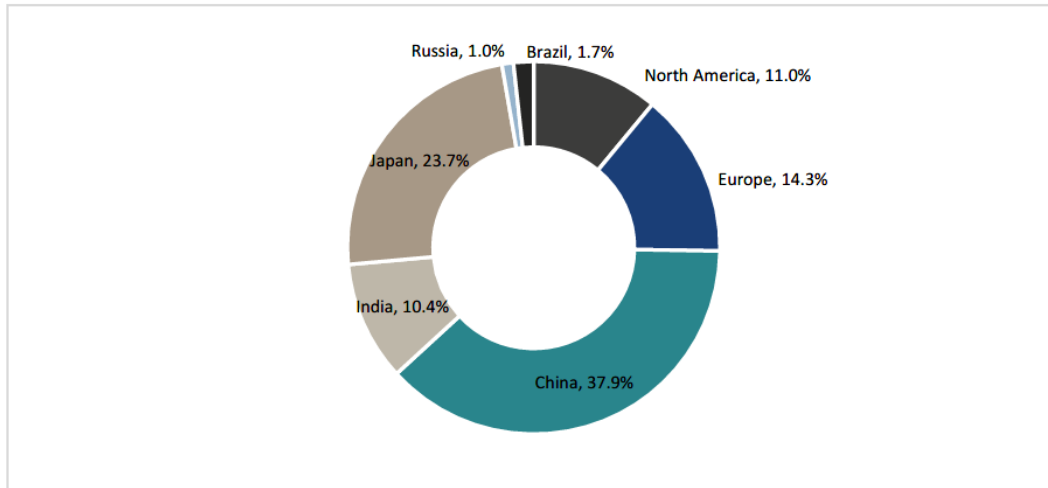

Source: CRISIL Research

**Compound Annual Growth Rates – PMP**

Compounded Annual Growth Rates (%)	North America	Europe	Japan	China	India	Russia	Brazil	Total
Review (2016-20)	3.8%	4.9%	3.3%	36.7%	5.4%	26.8%	12.3%	12.9%
Outlook (2020-25)	7.5%	8.2%	9.2%	6.7%	9.5%	8.8%	10%	7.9%

**China and Japan occupy almost half of the PMP market**

Global market of the above defined PMP for articulated joints was an estimated USD 520 million in 2020, with 80% and above of the demand from four key geographies China, Japan, Europe and North America. The demand for such products is expected to grow at a healthy 7% - 9% CAGR in the 5-year period between 2020 – 2025, powered by strong volume growth in construction equipment production in key markets such as Japan and Europe.

PMP production (value) during 2020 – 2025 is expected to grow at a good pace even on a high base in certain geographies. Growth is expected to be seen mainly from Japan (8-10% CAGR between 2020 – 2025), and India (9-11% CAGR between 2020 – 2025). Higher volume growth of construction equipment in North America, due to increase in government investments in various infrastructure development projects such as re-building roads and bridges, modernizing public works systems and boosting broadband internet, among other major improvements to the nation’s infrastructure. In India, growth observed is probable to be motivated by the occurrence of online retail amenities, accessibility of machinery on a rental basis, increasing government funds in infrastructure development, augmentation in capital investments.

Major OEMs are developing technically intensive products, processes and applications which has led to higher mechanization of the construction equipment. This is expected to aid the growth of PMP industry.

In 2020, China occupies the major share (40%), and it has seen fastest growth (greater than 30%) amongst other geographies in last 5 years (2016-20).

**Construction equipment volume demand to remain stable in next five years**

Key driver for the construction equipment industry is the investment in infrastructure projects. From 2021-2025, growth is expected to be driven by North America, Europe and India due to higher expected investment in infrastructure projects. However, stable growth in major geographies such as China and Japan to limit the growth of construction equipment industry at 2-4% from 2021 to 2025.

*Worldwide Construction Equipment Production Market (763,000 units) in 2016*

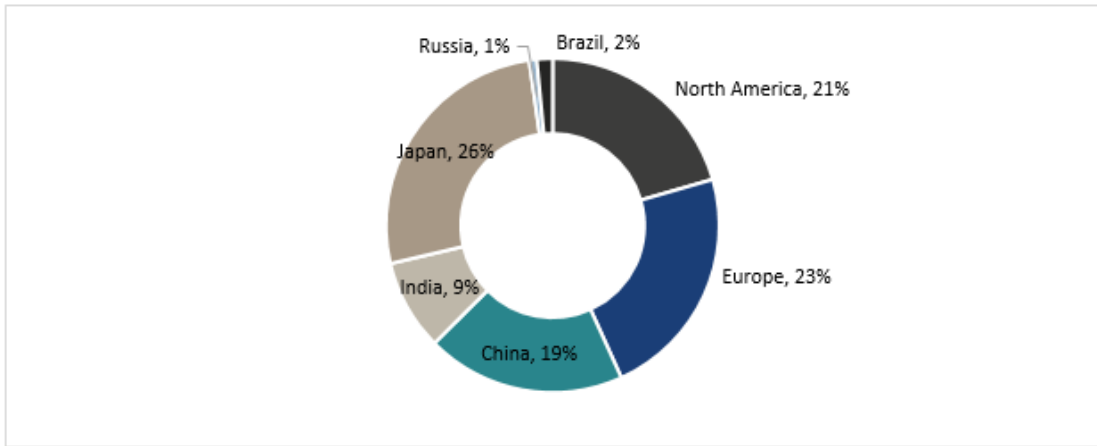

SOURCE: *Off-highway, Markets & Markets, CRISIL Research*

*Worldwide Construction Equipment Production Market (1080,000 units) in 2020*

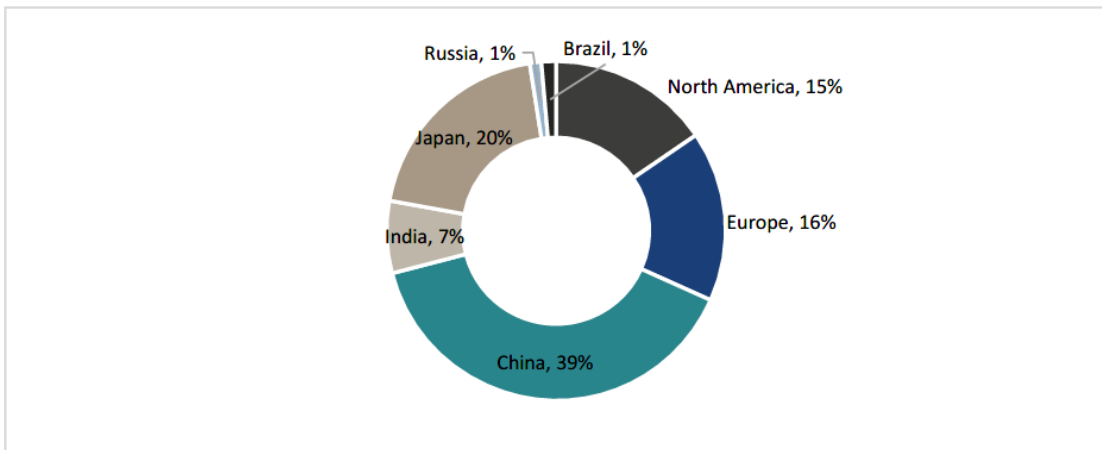

SOURCE: *Off-highway, Markets & Markets, CRISIL Research*

*Worldwide Construction Equipment Production Market (1,275,000 units) in 2025P*

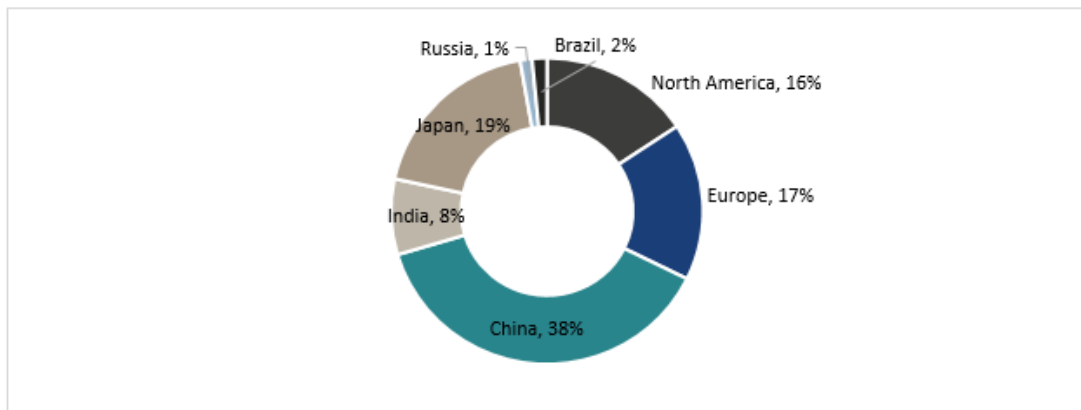

SOURCE: *Off-highway, Markets & Markets, CRISIL Research*

### Compound Annual Growth Rates – Construction Equipment

Compounded Annual Growth Rates (%)	North America	Europe	Japan	China	India	Brazil	Russia	Total
Review (2016-20)	1.6%	0.4%	1.3%	30.2%	2.6%	6.7%	20.6%	9.1%
Outlook (2020-25)	4.6%	4.8%	3.1%	3.5%	8.2%	6.9%	7.3%	4.2%

### Regional Demand of Key User Segment – Construction Equipment

#### North America

North America is one of the leading markets for construction equipment globally. In terms of sales volume in 2020, it is amongst the top five geographies for construction equipment market. The construction equipment market declined in 2020 on account of the COVID-19 pandemic. Equipment sales increased in 2021 with a strengthening economy and the need to renew an aging fleet of equipment. Annual value of construction in the US touched historically high levels in 2019.

*North America Construction Machinery – Unit Production by Category (%), (167,000 units in 2020)*

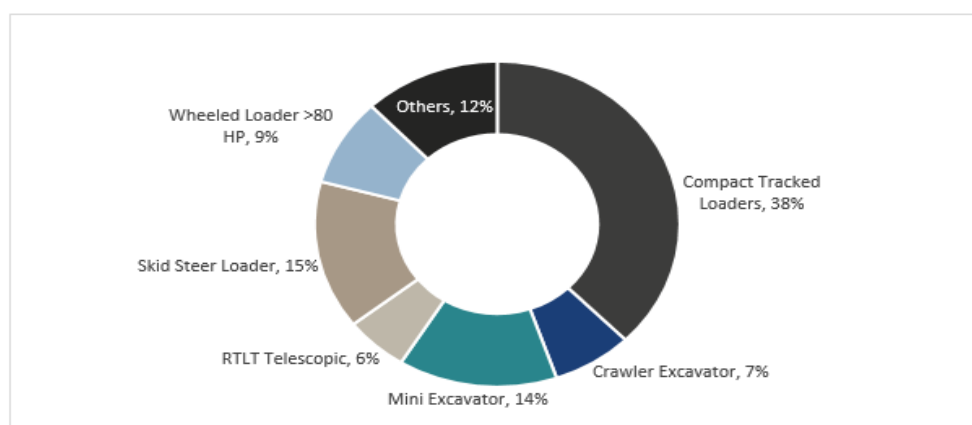

*Note: Others include backhoe loaders, motor graders, asphalt finishers, RILTs – masted, rigid dump trucks, less than 80 hp wheeled loaders, articulated dump trucks, wheeled excavators, and crawler loaders.*

*Source: Off-highway, CRISIL Research*

Key construction equipment companies operating in North America include Bobcat, Caterpillar, Deere & Company, JCB, Case New Holland, Manitou Group, Sumitomo Heavy Industries, Hyundai Heavy Industries, Hitachi Construction Machinery, Kobelco Construction Machinery, Komatsu and Volvo Construction.

#### Key Demand Drivers for Construction Equipment

- Focus on infrastructure development
- Growth in construction equipment rental market

#### Demand Review and Outlook

Driven by economic recovery, US construction spending is expected to grow to 6.9% of GDP in 2021 from 6.5% of GDP in 2016. This will be driven by growth across the residential, non-residential and non-building construction segments. As a result, North America's construction equipment volume is expected to grow. Coupled with change in price of raw material and increasing mechanisation, we expect the construction equipment market to grow at a CAGR of 3.7% over 2020 – 2025 to 199,807 units.



North America Construction Equipment Production Volume (units in thousands)

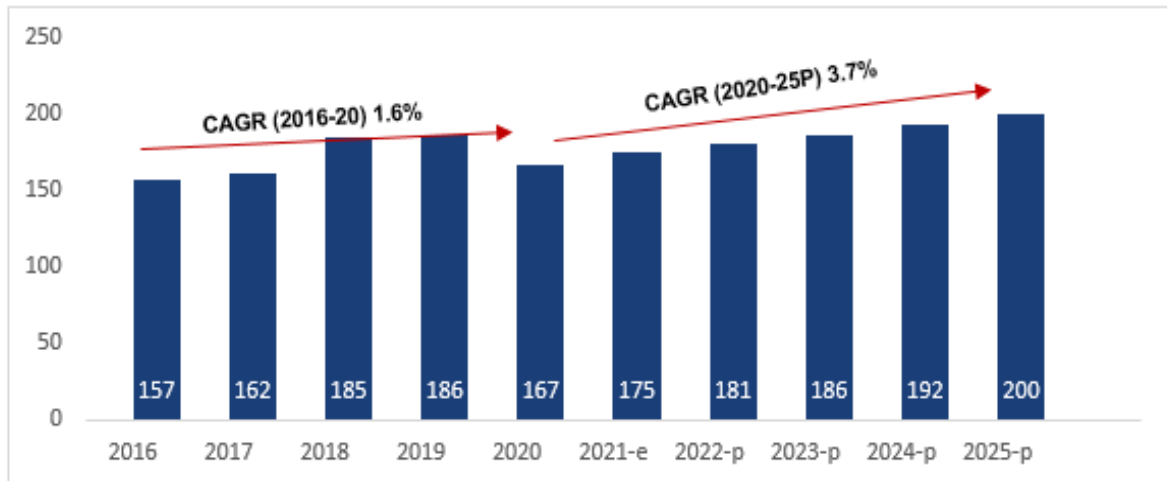

Source: Off-highway, CRISIL Research

North America Construction Equipment Production Value (USD Million)

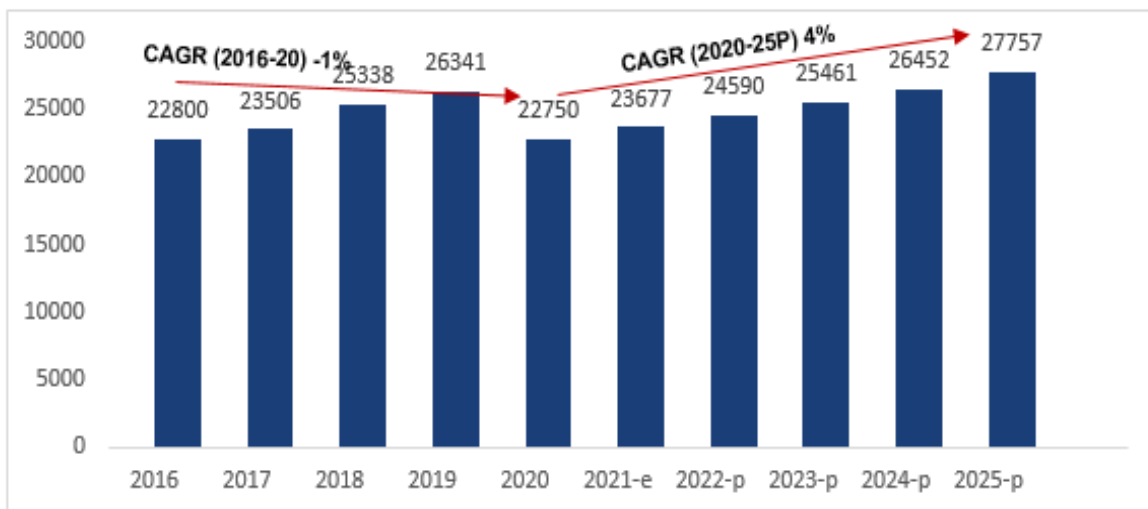

Source: Markets & Markets, CRISIL Research

## Europe

The construction equipment industry is an important part of the European engineering sector and plays a significant role in the EU economy. Europe is the third largest market for construction equipment worldwide, after China and North America, in terms of sales volume in 2020. Europe is also the third largest market for construction equipment globally, after China and Japan, in terms of production volume in 2020.

Germany, the UK, France, Italy, and the Netherlands are key countries for construction equipment in Europe. Germany, the UK, and France accounted for more than 50% of the total construction equipment sales in 2020.

Europe Construction Machinery – Unit Production by Category (%), (176,000 units in 2020)

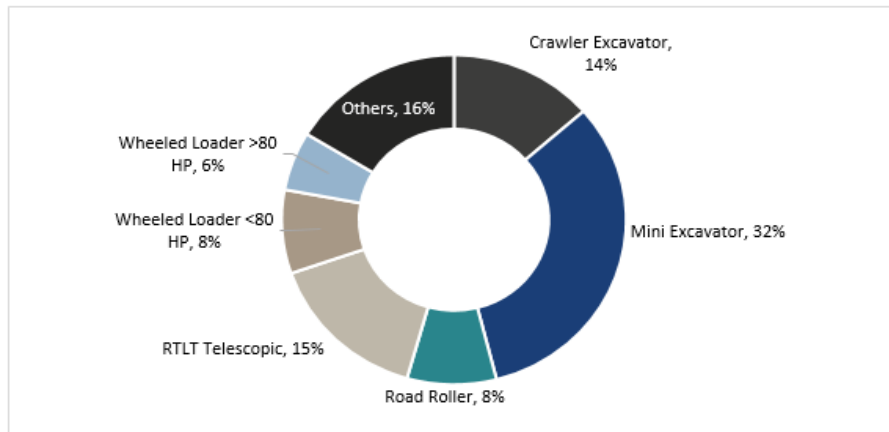

Note: Others include wheeled excavators, articulated dump trucks, asphalt finishers, crawler dozers, RTLTs – masted, skid steer loaders, crawler loaders, motor graders and rigid dump trucks.

Source: Markets & Markets, CRISIL Research

### Key Demand Drivers for Construction Equipment

- Recovery in the construction sector
- Steady need for replacement of older construction equipment

### Demand Review and Outlook

After declining in 2020, the European construction equipment industry expected to grow in 2021, with momentum growing during the year. The construction industry is in good shape in most markets. However, the growing threat to free trade and the risk of a global trade war pose a severe risk to the world economy. It is not clear yet if this will have an impact on the equipment market, and possibly result in changes in competitiveness between different regions.

Europe Construction Equipment Production Volume (units in thousands)

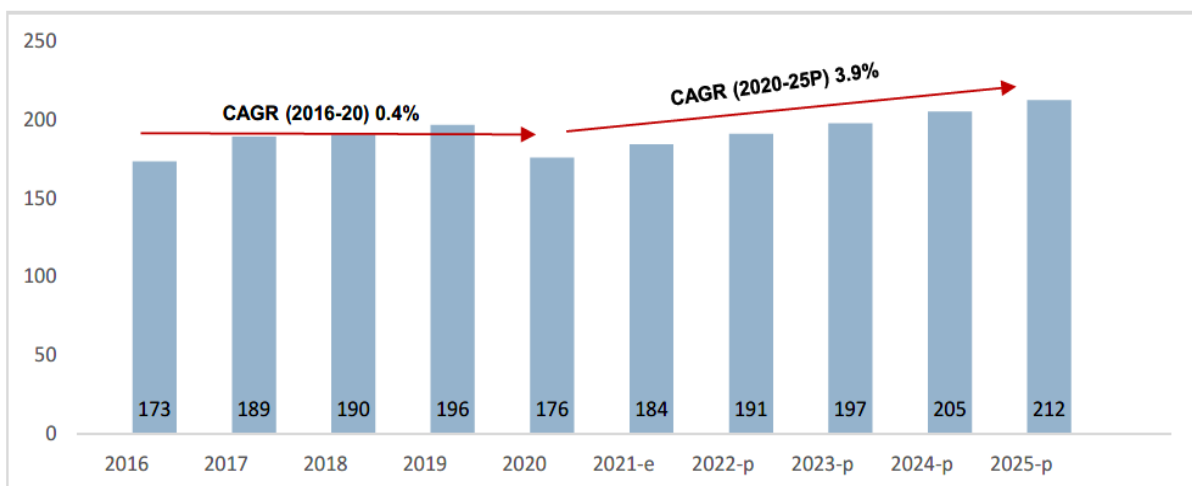

Note: CARC: Compound Annual Rate of Change

Source: Markets & Markets, CRISIL Research

*Europe Construction Equipment Production Value (USD Million)*

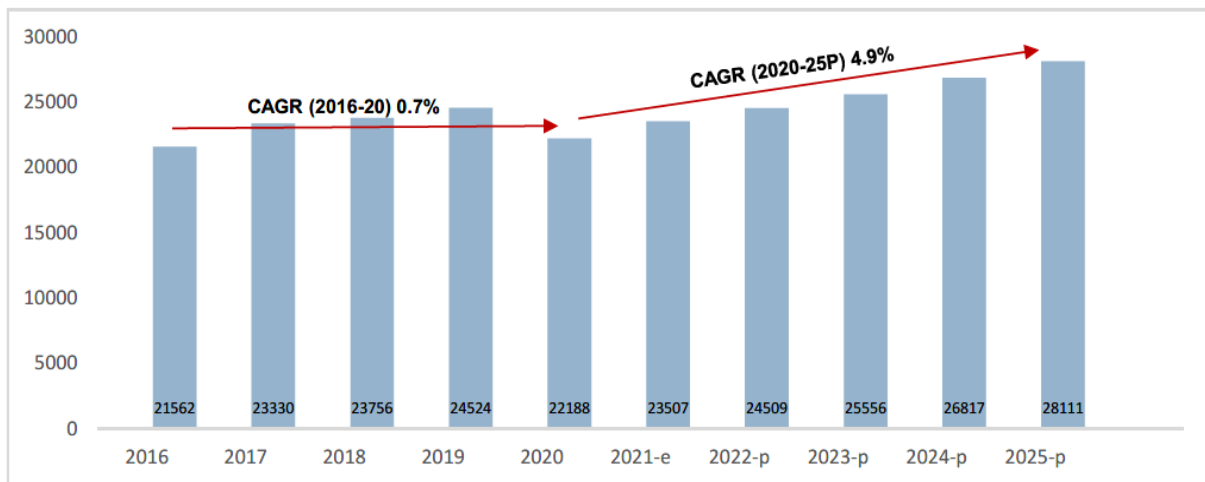

Source: Markets & Markets, CRISIL Research

### Japan

Japan is the second largest construction equipment market after China in 2020 in terms construction equipment production volumes. However, it exports approximately two-thirds of the production volumes mainly to North America and Europe. The growth in Japanese construction equipment industry is driven by increase in government spending on the rapid infrastructural developments in prominent sectors, including telecommunication, transport, and renewable energy, along with advanced technologies in construction equipment. Also, the reconstruction demand is rapidly growing as Japan is the most earthquake prone region in the world.

*Japan Construction Machinery - Unit Production by Category (%), (212,000 units in 2020)*

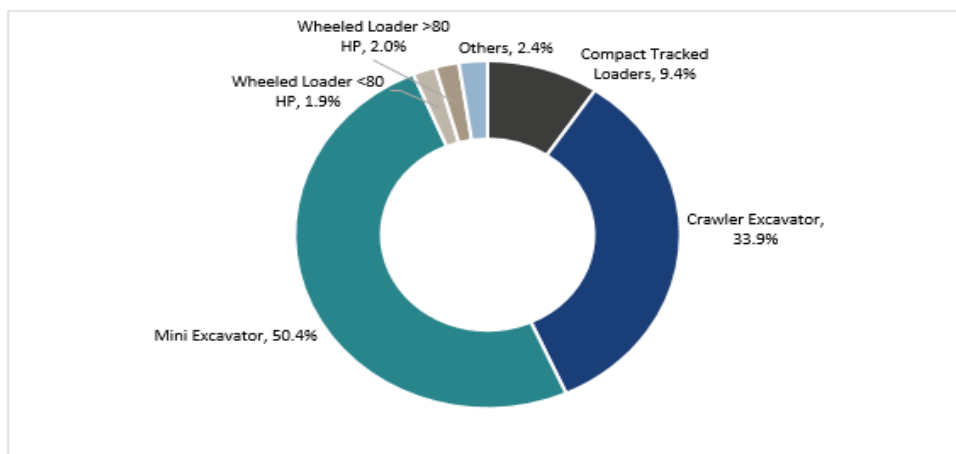

Note: Others include crawler dozers, rigid dump trucks, motor graders, skid steer loaders, articulated dump trucks, wheeled excavators, asphalt finishers, backhoe loaders, crawler loaders, RTLTs – masted, and RTLTs – telescopic.

Source: Off-highway, CRISIL Research

Key construction equipment manufacturers in Japan include Hitachi Construction Machinery, Komatsu, Kobelco Construction Machinery, Kubota, Sumitomo Heavy Industries. Komatsu and Hitachi Construction Machinery are among the top five biggest seller of construction equipment worldwide.

### Key Demand Drivers for Construction Equipment

- Increase in number of construction projects
- Government initiatives to improve productivity on construction sites

## Demand Review and Outlook

Over 2020 – 2025, construction equipment production is expected to grow at an annual rate of 2.5%, however, the market is expected to touch a level of 240,142 units in 2025. Key factors that will impact the market are infrastructure investments by the government to develop road, rail, and airport.

*Japan Construction Equipment Production Volume (units in thousands)*

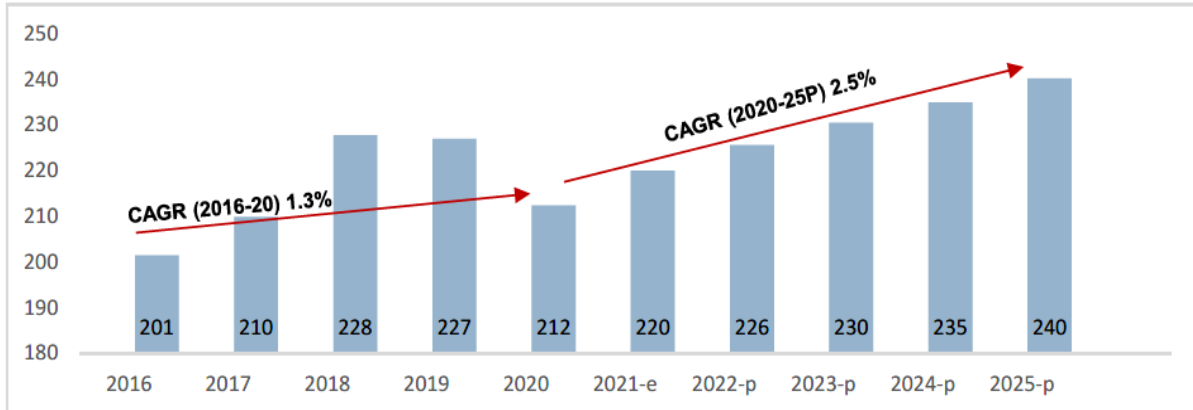

Note: CARC: Compound Annual Rate of Change

Source: Off-highway, CRISIL Research

*Japan Construction Equipment Production Value (USD Million)*

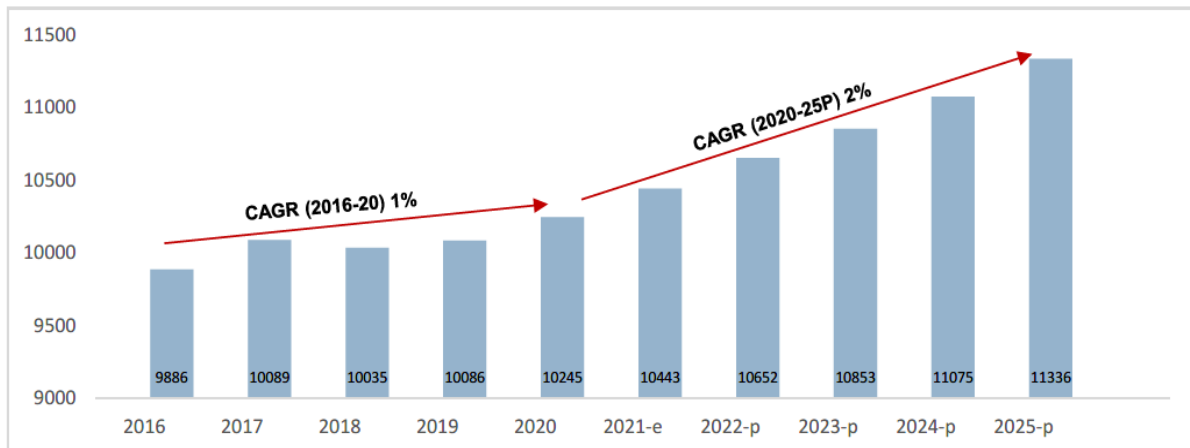

Source: Industry, CRISIL Research

## China

China is the largest market for construction equipment worldwide in terms of sales as well as production volumes in 2020. China exports construction equipment products mainly to Russia as well as other countries in Asia and Africa. Over the years, China has built a complete construction equipment production chain as all parts of the construction equipment production chain can be produced in the country.

[Remainder of this page intentionally kept blank]

China Construction Machinery - Unit Production by Category (%), (424,000 units in 2020)

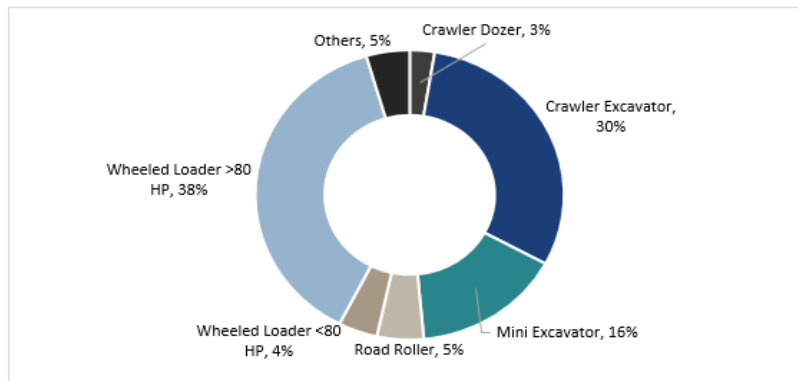

Note: Others include less than 80 HP wheeled loaders, asphalt finishers, skid steer loaders, wheeled excavators, backhoe loaders, rigid dump trucks, and articulated dump trucks.

Source: Markets & Markets, CRISIL Research

Key construction equipment companies operating in China include Zoomlion Heavy Industry Science & Technology Development Co, Sany Heavy Machinery, Xuzhou Construction Machinery Group (XCMG), LiuGong Machinery, Shantui Construction Machinery, Lonking, XGMA, and SDLG (a Volvo joint venture). A number of global companies such as Kobelco, Tadano, Caterpillar, and Liebherr are focusing on expanding their presence in the country.

#### Key Demand Drivers for Construction Equipment

- Growing Investment in The Construction Industry

#### Demand Review and Outlook

Construction equipment sales recovered over 2016-20 as new infrastructure projects launched during the period as part of the government’s ‘One Belt, One Road’ initiative positively impacted the market. With infrastructure investment now slowing, the construction equipment market is expected to slow down over 2020 – 2025. Over 2020 – 2025, the construction equipment production is expected to grow marginally at a CAGR of 2.7% to 486,045 units in 2025.

China Construction Equipment Production Volume (units in thousands)

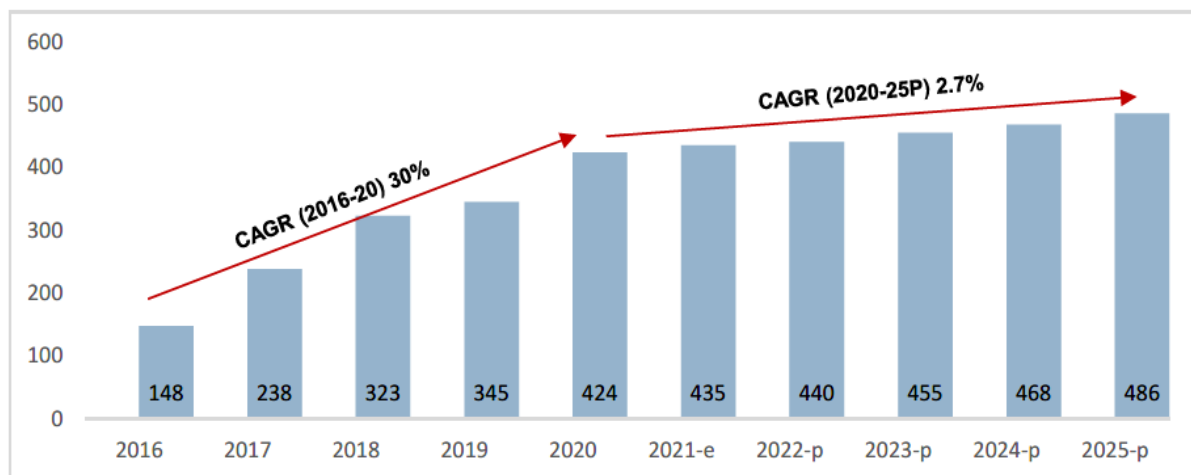

Note: CARC: Compound Annual Rate of Change

Source: Markets & Markets, CRISIL Research

*China Construction Equipment Production Value (USD Million)*

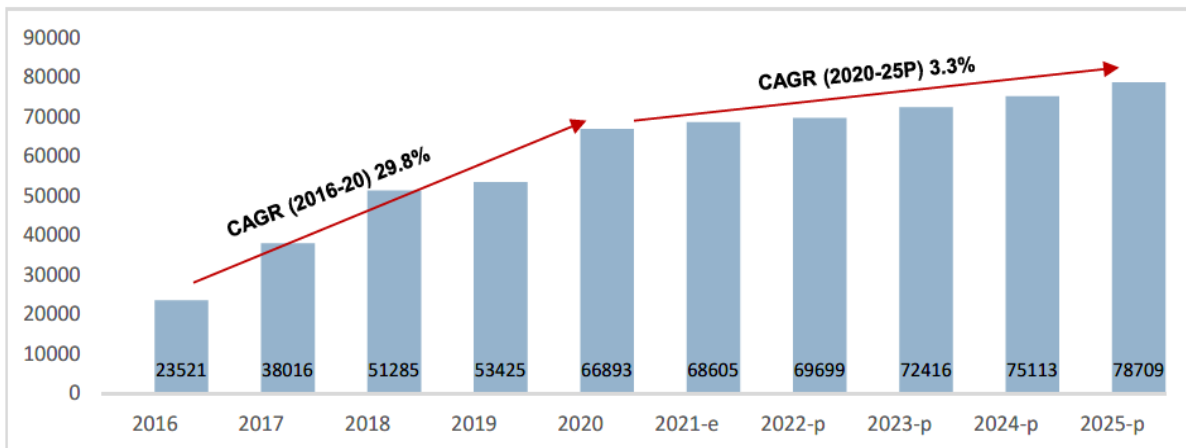

Source: Markets & Markets, CRISIL Research

**India**

Construction equipment can be broadly categorised as earthmoving and mining, material handling, road building, concreting, and material processing equipment. In Fiscal 2018, earthmoving and mining equipment (EME) makes up a major share (approximately 70%) of the construction equipment industry.

EME, in turn, comprises backhoe loaders, excavators, wheeled loaders, skid steer loaders, and dumpers. Excavators, backhoe loaders, and wheeled loaders account for 85% - 90% of the EME industry's revenue. In the construction sector, EME is mainly used in infrastructure and industrial construction. These equipments are used in roads, hydropower projects, irrigation, industrial construction, mining, agriculture, waste management, and logging.

Material handling equipment (MHE) are used for storage and movement of bulk or non-bulk goods within a particular premise. It comprises pick and carry cranes and forklifts. Road building equipment are used in various phases of the road construction. Examples are bulldozers, diggers, and scrapers. Concreting equipment are used to mix and transport concrete, and include pumps and transit mixers. Material processing equipment include crushers and compressors.

Major players in the construction equipment space are JCB (highest market share in backhoe loaders) and Tata Hitachi (highest market share in excavators). Other players include Case New Holland, Caterpillar, Terex, Mahindra Construction Equipment, L&T Construction Equipment, Hyundai and Bharat Earth Movers Limited.

Leading players in the construction equipment industry have been able to maintain market share as new players have not been able to provide discounts, given their fragile financials, caused by a prolonged downturn. Large players in the backhoe loader and excavator segments will continue to dominate, with a widespread after-sales service network, revenue from which makes up for lower equipment sales.

*India Construction Machinery – Unit Production by Category (%), (74,000 units in 2020)*

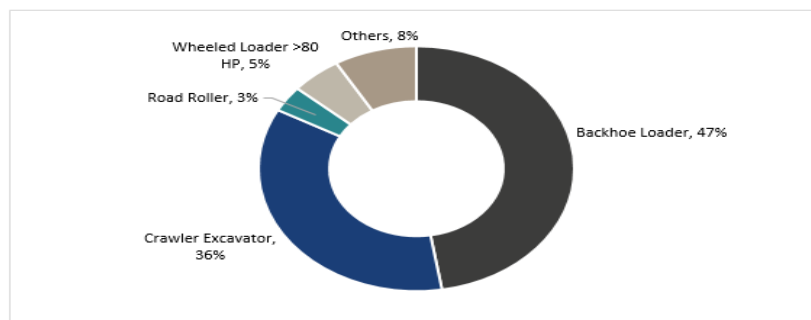

Source: Markets & Markets, CRISIL Research

*Backhoe loaders market share (Fiscal 2020)*

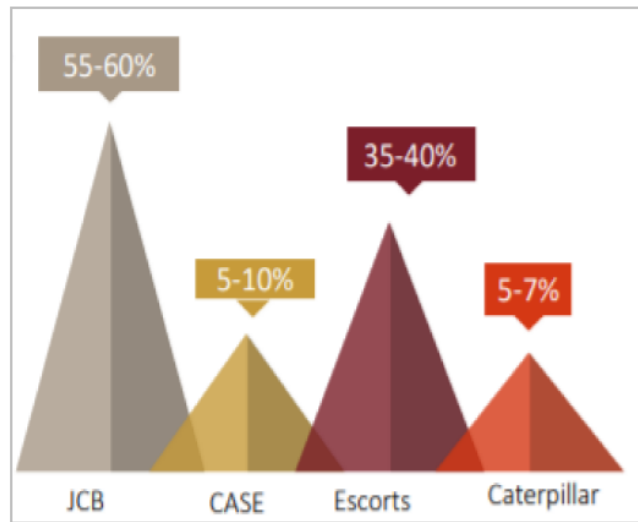

Source: Industry, CRISIL Research

*Excavator market share (Fiscal 2020)*

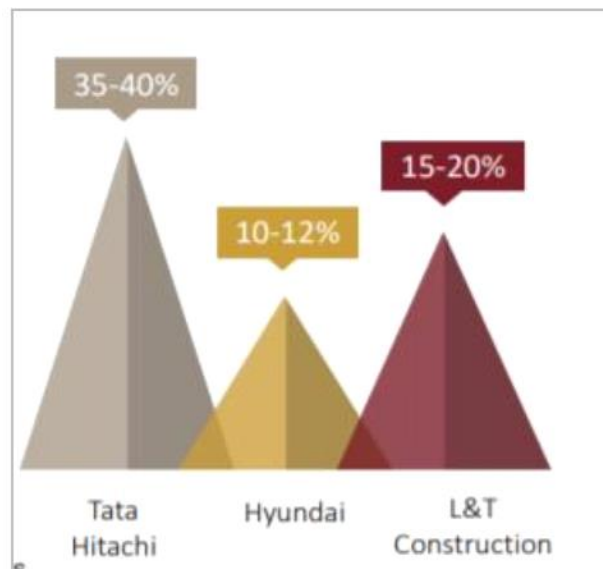

Source: Industry, CRISIL Research

JCB India is the leader in the backhoe loader segment, commanding approximately 60% market share. It introduced the backhoe loader in 1979 and currently has the widest dealer network of approximately 500 outlets, a diversified product range, and strong brand recall even in Tier 2 and 3 cities. These key strengths have helped the company maintain its position. Other players include Case New Holland, Caterpillar, Tata Hitachi and Escorts.

Tata Hitachi and L&T Construction Equipment are major players in excavator space having technology collaborations with Japanese companies Hitachi and Komatsu. Moreover, these companies stand to gain from their partner companies' experiences in other Asian markets, where they have a strong foothold. Tata Hitachi leads the segment with its wide dealership network of over 300 outlets and popular models. L&T Construction Equipment has recovered its lost share from competitors by focusing on high quality models. Hyundai, Volvo, Caterpillar, JCB India, and BEML are the other major players.

Other earth moving equipment includes wheeled loaders, crawler dozers (bulldozers), compaction equipment, skid-steer loaders, and motor graders, used in mining, road construction and soil levelling. These comprised

approximately 16% in volume and value terms of the EME market in 2020. BEML, Caterpillar, and Tata Hitachi are major players, while Liugong and Kobelco are new entrants. We do not expect any major change in the top three players' market share over the next 2-3 years, as new ones are still trying to establish a stable dealership and after-sales service network.

### Key Demand Drivers for Construction Equipment

- Construction investments expected to grow at a good pace
- Focus on infrastructure development

### Demand Review and Outlook

The momentum seen from 2016 till date is expected to continue until 2025. We expect the Indian construction industry to grow at a compounded annual growth rate (CAGR) of 6.5% (in volume terms) between calendars 2020 and 2025, i.e., almost twice the growth rate between calendars 2016 and 2020.

In value terms, construction equipment market is expected to grow at 7.2% CAGR between 2020 and 2025.

According to the current announcement by the Government of India, Bharat Stage Construction Equipment Vehicles (CEV)-IV norms will be implemented from April 1, 2021. Manufacturing of CEV-III equipment will stop from October 1, 2020 and sale of such equipment will end from April 1, 2021. Post implementation of CEV-IV, price of the equipment is expected to increase marginally, owing to changes required in engine and its parts.

Infrastructure is projected recording a 17% - 20% on-year rise led by health increases in centre and state budgets with the mining sector too expected to grow from Fiscal 2021 lows. The volumes for the sector are seen rising 6% - 9% on year in Fiscal 2022 with price hikes accounting for the balance growth. The sharp rise in input prices, appreciating yen coupled with implementation of the new emission norms from April 1, 2021 have necessitated the rise in prices.

Overall, the industry expects growth momentum in construction activity to sustain. In a bid to stay on top, construction equipment firms are building manpower and technical capabilities as they enter newer segments and launch new products.

While nearly all type of equipment will witness growth, the market will continue to be dominated by popular products such as backhoe loaders, crawler excavators, mobile cranes, mobile compressors, compaction equipment, and wheeled loaders.

*Indian construction equipment market, production volume (units in thousands)*

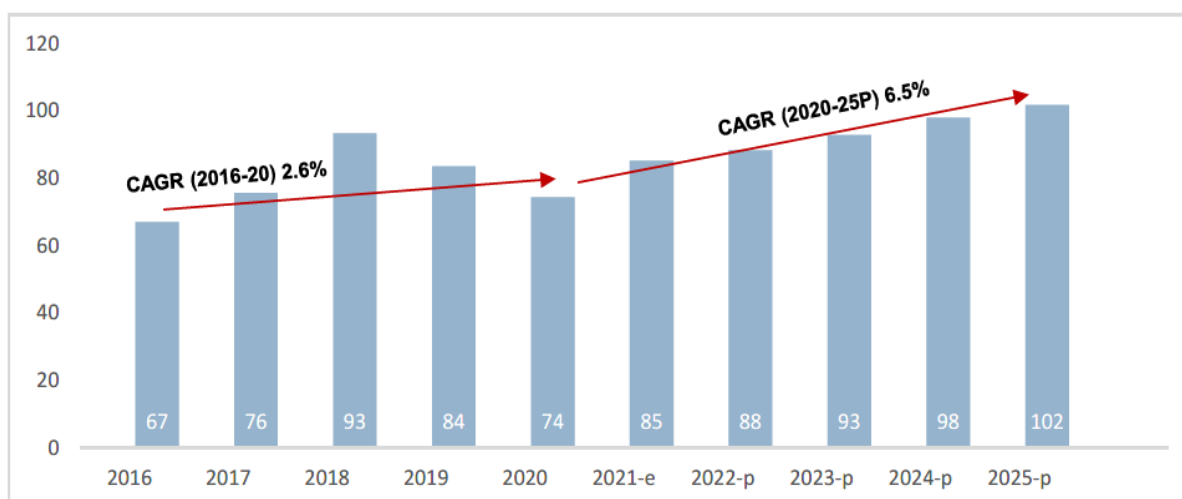

Source: Markets & Markets, CRISIL Research



*Indian construction equipment production value (USD million)*

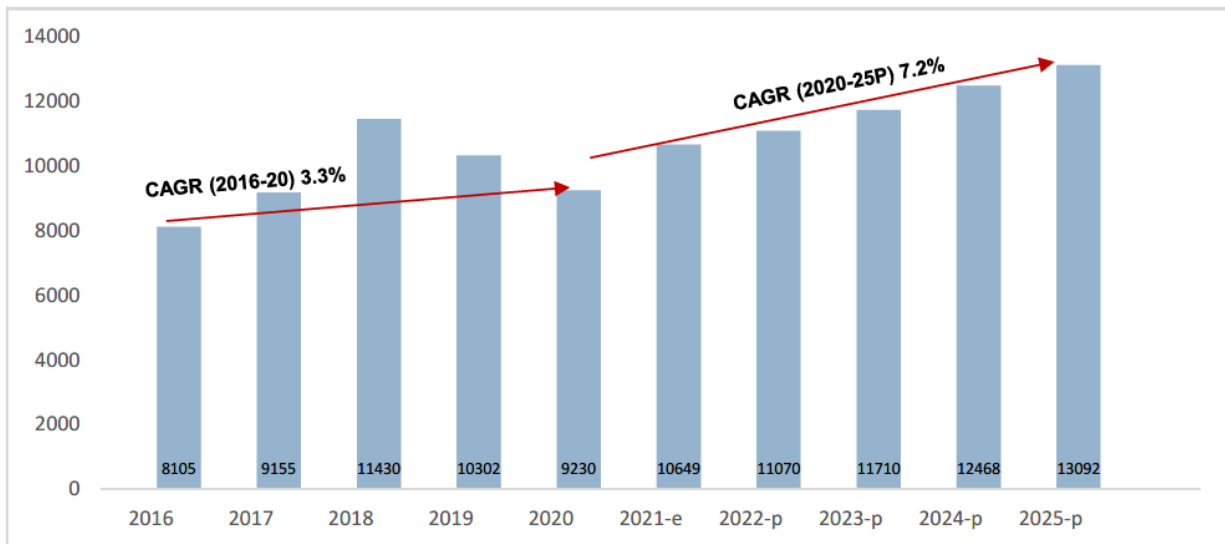

Source: Markets & Markets, CRISIL Research

Market size and outlook by region (Precision Machined Product)

**World Market**

Precision machined product (PMP) is a group of products that are components requiring stringent material and manufacturing specifications and controls. These include among others, precision machined components e.g. Pins and bushes used in articulated joints (AJ) across the construction, forestry and mining equipment. Our current study focuses on mapping the market for such precision machined components for articulated joints (“PMP for AJ”).

The world market for PMP for AJ is estimated to be USD 520 million in 2020. Global production value for PMP for AJ is expected to grow at CAGR of 7% - 9% during 2020 – 2025, registering a decrease in the growth rate compared to 2016 – 2020 period which was a CAGR of 12.9%.

This expansion will be fuelled primarily by growth in North America and India, where construction spending, especially on infrastructure projects, continues to increase.

China, being the largest market globally, contributes around 40% to the total market share and is expected to grow at a CAGR of 6% - 8% from 2020 – 2025.

India, contributing around 10%, is expected to grow at a CAGR of 9% - 11% from 2020 – 2025 due to higher investments towards infrastructure activities and expansion plans by various construction equipment manufacturers.

Japan and Europe are the second and third largest consumers of PMP for AJ parts respectively, contributing approximately 36% of the world market.

*[Remainder of this page intentionally kept blank]*

Precision Machine Parts for AJ - Market Value (USD Million)

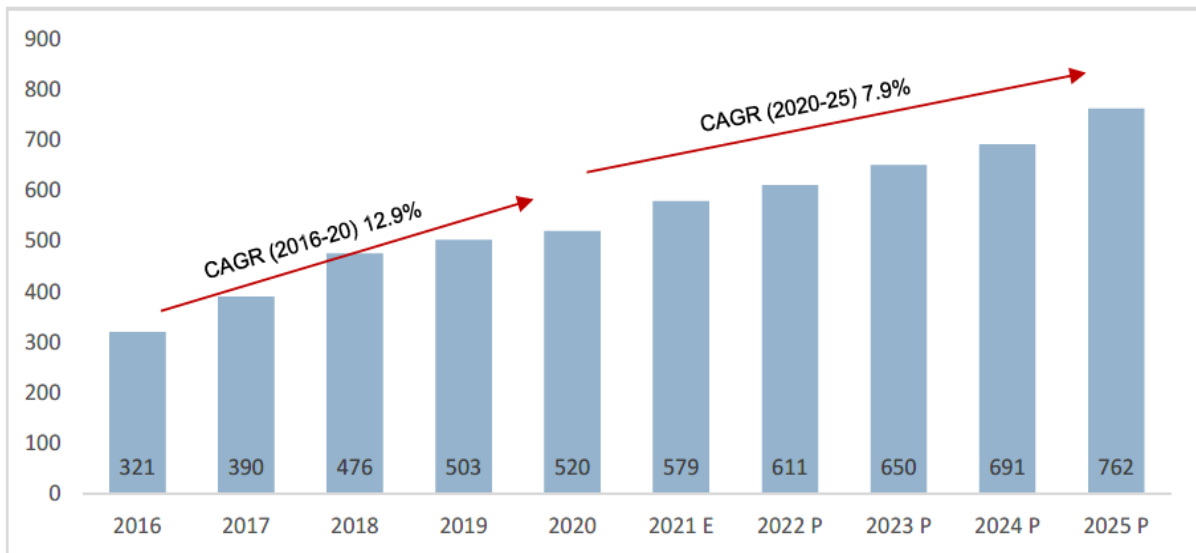

NOTE: E-Estimate; P-Projected

SOURCE: CRISIL Research

Note: The above projections does not include any impact of the on-going Russia & Ukraine crisis

North America

North America PMP for AJ market is approximately USD 58 million in 2020, with major construction equipment manufactured being skid steer loader, crawler excavator, mini excavators and more than 80 HP wheeled loaders. The market is expected to grow at a CAGR of 7.5% over 2020 – 2025 to USD 84 million in 2025. Growth will be driven by higher spending in construction activities by USA and Canada,

Structure of Unit Production by Product Category (% of Total)

Year	Skid Steer Loaders	Crawler Excavators	Mini Excavators	Wheeled Loaders > 80 HP	RTLs Telescopic	Compact Tracked Loader	Others
2020	8%	26%	11%	14%	5%	20%	17%

Source: Industry, CRISIL Research

North America PMP Market Value (USD Million)

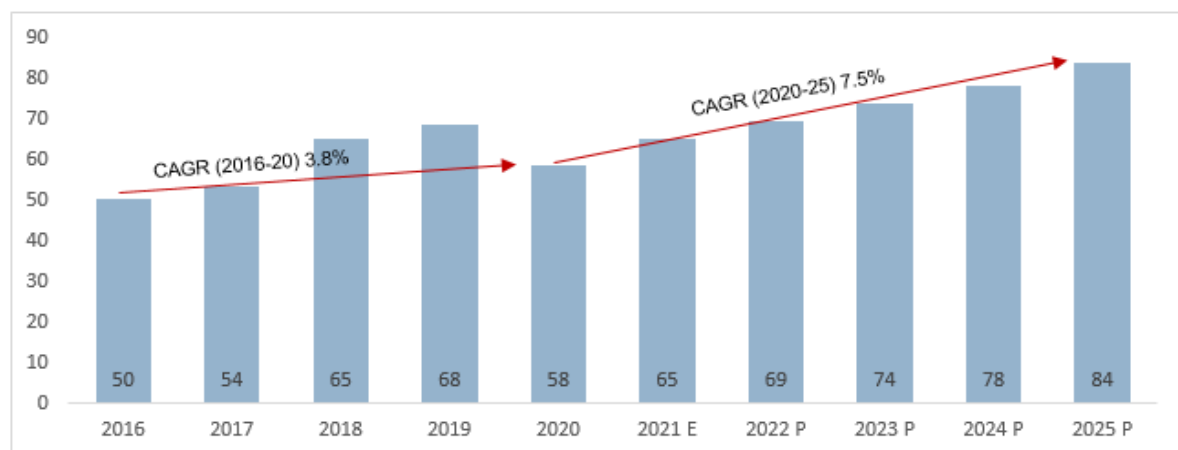

Source: Industry, CRISIL Research

## Europe

Europe PMP for AJ market is approximately USD 73 million in 2020, with major construction equipment manufactured being RLTs - telescopic, mini excavators, wheeled and backhoe loaders. The market is expected to grow at a CAGR of 8.2% over 2020 – 2025 to USD 109 million in 2025. This strong growth in next five years is backed by government spending on infrastructure.

*Structure of Unit Production by Product Category (% of Total)*

Year	RLTs Telescopic	Mini Excavators	Wheeled Loaders < 80 HP	Wheeled Loaders > 80 HP	Crawler Excavators	Others
2020	11%	20%	4%	8%	40%	17%

Source: Industry, CRISIL Research

*Europe PMP Market Value (USD Million)*

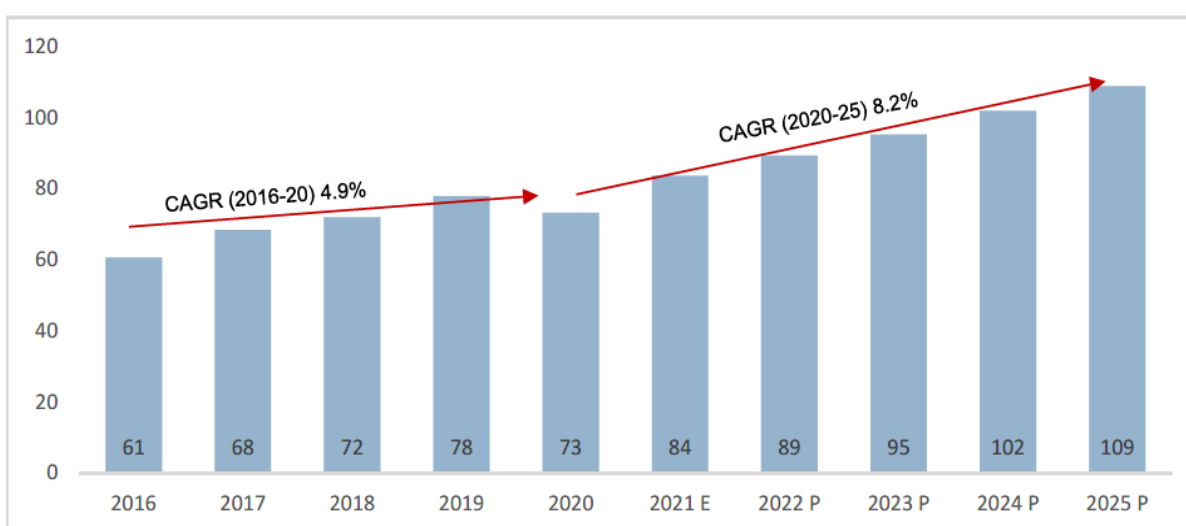

Source: Industry, CRISIL Research

## Japan

Japan PMP for AJ market is approximately USD 116 million in 2020, with major construction equipment manufactured being skid steer loaders, excavators (mini and crawler) and wheeled loaders. The market is expected to grow at a CAGR of 9.2% over 2020 – 2025 to USD 181 million in 2025. PMP growth will be impacted by demand for construction equipment due to investments by the government to develop road, rail, and airport.

*Structure of Unit Production by Product Category (% of Total)*

Year	Crawler Excavators	Mini Excavators	Wheeled Loaders > 80 HP	Others
2020	76%	20%	2%	3%

Source: Industry, CRISIL Research

Japan PMP Market Value (USD Million)

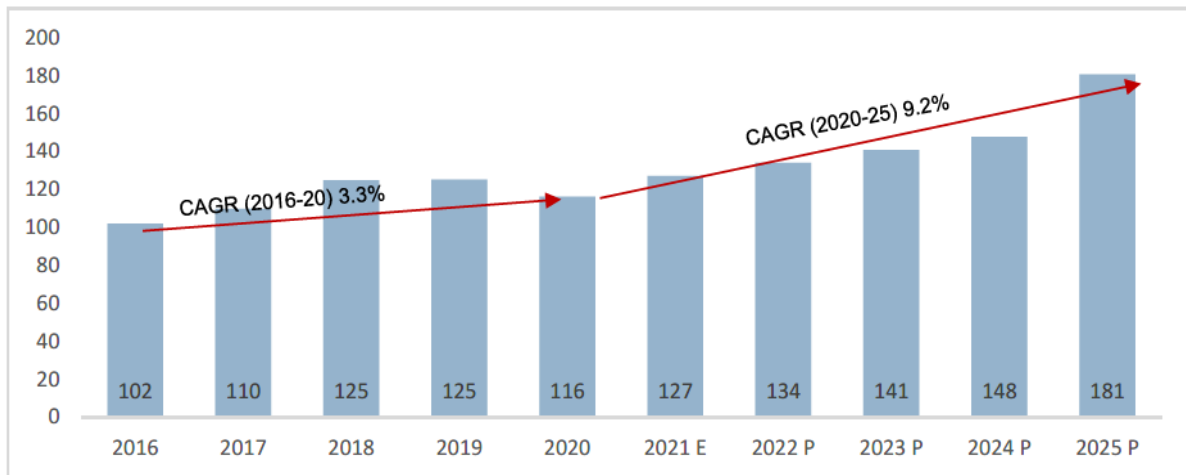

Source: Industry, CRISIL Research

### China

China PMP for AJ market is approximately USD 209 million in 2020, with major construction equipment manufactured being excavators (mini and crawler), wheeled loaders and crawler dozers. The market is expected to grow at a CAGR of 6.7% over 2020 – 2025 to USD 289 million in 2025. PMP demand will be driven by increase in investment in infrastructure activities mainly China’s Belt and Road Initiative.

Structure of Unit Production by Product Category (% of Total)

Year	Crawler Excavators	Wheeled Loaders > 80 HP	Mini Excavators	Others
2017	58%	31%	6%	4%

Source: Industry, CRISIL Research

China PMP Market Value (USD Million)

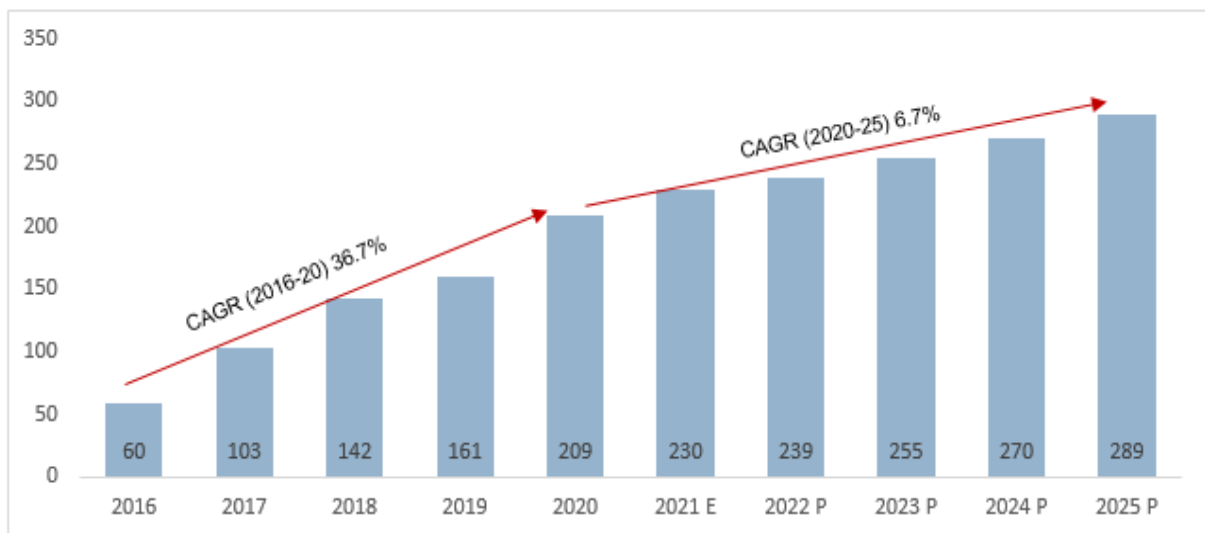

Source: Industry, CRISIL Research

## India

India's PMP market for pins and bushes used in articulated joint was approximately USD 50 million in 2020, with major construction equipment manufactured being backhoe loader and crawler excavator. From 2016 to 2020, PMP market has grown by 5.4% CAGR on account of push by the Government towards infrastructure and other construction related activities.

We expect PMP market in India to grow by 9.5% CAGR between fiscals 2020 and 2025 to approximately USD 79 million, surpassing growth in the previous 4 years, owing to higher expected growth in the construction equipment market.

### Structure of unit production by product category (% of total)

Year	Backhoe loader	Excavator	Wheeled loader	Rigid dump trucks	Others
2017	41%	52%	3%	2%	2%

Source: Industry, CRISIL Research

### India PMP market value in (USD million)

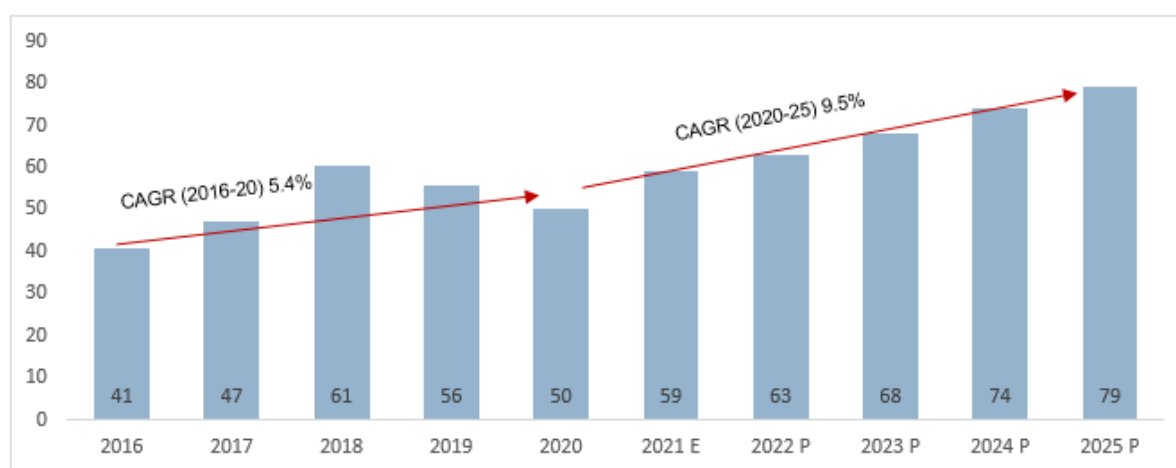

NOTE: For calculating market size of PMP, construction equipment such as backhoe loader, excavator, wheeled loader, skid steer loader, and rigid dump trucks have been considered.

Source: Industry, CRISIL Research

## OEM Profile

### Revenue

Company	Currency	2016	2017	2018	2019	2020	4-year CAGR (2016-20)
AGCO Corp.	USD billion	7.4	8.3	9.3	9.0	9.15	5%
Caterpillar Inc.	USD billion	38.5	45.5	54.7	53.8	41.7	2%
CNH Industrial NV	USD billion	25.3	27.9	29.7	28.0	26.0	1%
Deere & Co.	USD billion	26.6	29.7	37.3	39.2	35.5	7%
Kubota Corp	Yen billion	1596.1	1751.5	1850.3	1920.0	1853.2	4%

NOTE:

Financial year ending of AGCO, Caterpillar, CNH Industrial, Kubota is in December

Financial year ending of Deere & Co. is in October

SOURCE: Company Reports, CRISIL Research

## Uniparts Profile

Company	Currency	2017	2018	2019	2020	2021	4-year CAGR (2016-20)
Uniparts Limited	India INR billion	6.94	8.43	10.62	9.39	9.48	8%

*NOTE:*

*Financial year ending of Uniparts is in March*

*SOURCE: Company Reports, CRISIL Research*

Uniparts is an Indian based global manufacturer of engineered systems and solutions. It is one of the leading suppliers of systems and components for the off-highway market on account of its presence across 25 countries. It operates out of six manufacturing facilities and four warehousing locations across US, Europe and India. Uniparts' large India manufacturing footprint and economies of scale helps provide cost competitiveness in an otherwise discreet manufacturing set up involving a large range of SKUs. The company's major business areas are agriculture, construction and forestry, and after-market. They have a leading presence in the manufacture of 3PL and PMP products globally serving some of the largest global companies.

## OUR BUSINESS

Some of the information in this section, including information with respect to our business plans and strategies, contain forward-looking statements that involve risks and uncertainties. You should read “**Forward-Looking Statements**” on page 17 for a discussion of the risks and uncertainties related to those statements and also “**Risk Factors**”, and “**Management’s Discussion and Analysis of Financial Condition and Results of Operations**” on pages 27 and 355, respectively, for a discussion of certain factors that may affect our business, financial condition or results of operations. Our actual results may differ materially from those expressed in or implied by these forward-looking statements.

Unless otherwise indicated or the context otherwise requires, the financial information included herein is based on or derived from our Restated Financial Statements included in this Draft Red Herring Prospectus. For further information, see “**Restated Financial Statements**” on page 212.

Unless the context otherwise requires, in this section, references to “we”, “us” and “our” refer to Uniparts India Limited on a consolidated basis while “our Company” or “the Company”, refers to Uniparts India Limited on a standalone basis.

Unless otherwise indicated, industry and market data used in this section has been derived from industry publications, in particular, the report titled “Global Market Assessment of 3PL and PMP Products in Agriculture and Construction Equipment” dated April, 2022 (the “**CRISIL Report**”) prepared and issued by CRISIL Limited, appointed by us on December 15, 2021 and exclusively commissioned and paid for by us in connection with the Offer. A copy of the CRISIL Report is available on the website of our Company at [www.unipartsgroup.com/ipo-industry-reports.asp?links=inv52](http://www.unipartsgroup.com/ipo-industry-reports.asp?links=inv52). The data included herein includes excerpts from the CRISIL Report and may have been re-ordered by us for the purposes of presentation. There are no parts, data or information (which may be relevant for the proposed Offer), that has been left out or changed in any manner. Unless otherwise indicated, financial, operational, industry and other related information derived from the CRISIL Report and included herein with respect to any particular year refers to such information for the relevant calendar year. For further information, see “**Risk Factors – Industry information included in this Draft Red Herring Prospectus has been derived from an industry report commissioned by us, and paid for by us for such purpose.**” on page 34. Also see, “**Certain Conventions, Use of Financial Information and Market Data and Currency of Presentation – Industry and Market Data**” on page 15.

## OVERVIEW

We are a global manufacturer of engineered systems and solutions and are one of the leading suppliers of systems and components for the off-highway market in the agriculture and construction, forestry and mining (“**CFM**”) and aftermarket sectors on account of our presence across over 25 countries (Source: CRISIL Report). We are a concept-to-supply player for precision products for off-highway vehicles (“**OHVs**”) with presence across the value chain. Our product portfolio includes core product verticals of 3-point linkage systems (“**3PL**”) and precision machined parts (“**PMP**”) as well as adjacent product verticals of power take off (“**PTO**”), fabrications and hydraulic cylinders or components thereof. We have a leading presence in the manufacture of 3PL and PMP products globally on account of us serving some of the largest global companies (Source: CRISIL Report). Most of our products are structural and load bearing parts of the equipment and are subject to strict tolerances, specifications and process controls. A series of precision engineering process steps converge in to manufacturing of these products. We had an estimated 14.45% market share\* of the global 3PL market in Fiscal 2021 in terms of value and an estimated 5.87% market share\*\* in the global PMP market in the CFM sector in Fiscal 2021 in terms of value. We also cater to the aftermarket segment especially for 3PL product range. We provide replacements of 3PL parts to organized aftermarket retailers and distributors in North America, Europe, South Africa and Australia.

\* Computed as our 3PL sales in Fiscal 2021 (being USD 45.15 million) divided by the 3PL median market size for calendar year 2020 (being USD 312.5 million) (as per the CRISIL Report).

\*\* Computed as our PMP sales in Fiscal 2021 (being USD 30.52 million) divided by the PMP median market size for calendar year 2020 (being USD 520.0 million) (as per the CRISIL Report).

A brief description of the core products we manufacture is set out below:

**3PL:** The 3-PL systems consist of different assemblies that are attached to an agricultural tractor. It forms a group of assemblies allowing attaching an implement like a plough to the tractor at 3 coupling points. (Source: CRISIL Report) The systems are engineered customised to each tractor model and region in which the tractor is used as the specifications vary from region to region. These systems are subject to validation and have to comply with international standards.



**PMP:** PMP is a group of products that are components requiring stringent material and manufacturing specifications and controls. These include among others, precision machined components such as pins, bushes and bosses used in articulated joints. (Source: CRISIL Report) These are structural and load bearing parts of the equipment and are subject to strict tolerances, specifications and process controls. The product varies in design and technical specification between different applications. The number of SKUs are high and varied in this product category.

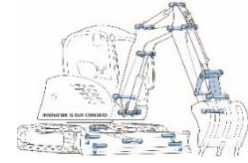

The world market for 3PL was between USD 305 million and USD 320 million in 2020 and is expected to grow at nearly 6% and 8% between 2020 – 2025, buoyed by robust growth in tractor production volumes in North America, India and Europe, steady growth in China and Japan. A major driver of 3PL demand is tractors and the demand for 3PL is set to grow at a steady, healthy pace. Although India and China have a share of nearly 62% of the world tractor production, their share in global 3PL demand is only around 38%. North America, being one of the most mature tractor markets, contributes around 12% of the world tractor demand, and contributed almost 19% of the total demand for 3PL in the world in 2020. The global market for PMP for articulated joints was USD 520 million in 2020, with 80% and above of the demand from four key geographies China, Japan, Europe and North America. The demand for PMP products is expected to grow at a CAGR of 7% and 9% between 2020 and 2025, powered by strong volume growth in construction equipment production in key markets such as Japan and Europe. (Source: CRISIL Report) We believe we are well positioned to benefit from increasing mechanization in the agriculture and CFM sectors, in particular through leveraging our global business model, which allows us to efficiently serve OEMs across multiple global locations, contributing to their increasing efforts to rationalize their supply chain and asset/working capital management.

We offer fully integrated engineering solutions from conceptualization, development and validation to implementation and manufacturing of our products. The conceptualization stage involves acquiring market intelligence, assessing customer requirement and formulating customized strategy for individual customers. The development phase includes product designing, material procurement and processing. This is followed by the validation phase, which involves prototyping, testing and feasibility analysis. Our in-house manufacturing and implementation competencies include forging, machining, fabrications, heat treatment, surface finish, logistics, quality and testing, design and validation. By means of servicing our aftermarket segment customers, our products find indirect access to a large set up of retail stores across geographies for aftermarket components. Within the aftermarket category, we are focused on the ‘will-fit’ parts segment, sold to distributors and retail chain stores.

In Fiscal 2019, 2020 and 2021 and in the nine months ended December 31, 2021, revenue generated from the agriculture and CFM segments together constituted 95.59%, 95.74%, 96.07% and 95.42%, respectively, of our total revenue from operations. Our customer base comprises a number of the global OEMs and in our experience, our ability to serve such customers has allowed us to scale our operations over the years. We have long-term relationships with global OEM players in the agriculture and CFM sectors, such as Tractors and Farm Equipment Limited (“TAFE”), Doosan Bobcat North America (“Bobcat”), Claas Agricultural Machinery Private Limited (“Claas Tractors”), Yanmar Global Expert Co., Ltd (“Yanmar”) and LS Mtron Limited. We service several organized aftermarket players and large farm and fleet retail store chains in Europe and the US, such as Kramp Groep B.V. (“Kramp”) and Tractor Supply Company (“TSC”). As of December 31, 2021, our customer base comprised over 125 customers in over 25 countries globally. Bobcat, TAFE and Kramp are some of the customers with whom we have had relationships for over 15 years, while with customers like Yanmar, we have a relationship with for over 10 years. More recently, we have added TSC and Kobelco Construction Equipment India Private Limited (“Kobleco”) as our customers. Customers we acquired in 2017 onwards, accounted for 4.80%, 6.97%, 11.13% and 9.62%, respectively, of our revenue from operations in Fiscal 2019, 2020 and 2021 and the nine months ended December 31, 2021.

As of December 31, 2021, we have a global footprint and served customers across countries in North and South America, Europe, Asia and Australia, including India. We primarily serve OHV players including OEMs and aftermarket retail store chains, through our global business model based on our dual-shore integrated manufacturing, warehousing and supply chain management systems and solutions. Our global business model has



contributed in the evolution of our relationships with our key customers, as we are able to serve multiple delivery locations and provide multiple delivery options with flexible lead times and costs, allowing us to better serve our customers with multiple price points based on different delivery models.

Our global business model is based on our sales in regions outside India (“**International Sales**”); sales from our dual shore manufacturing facilities in India and United States, in their respective domestic markets (“**Local Deliveries**”); export sales from Indian locations directly to overseas customers (“**Direct Exports**”); and sales from our warehousing facilities in their respective domestic markets (“**Warehouse Sales**”). The table below sets forth details of our revenues based on our global business model:

Particulars	Fiscal 2019		Fiscal 2020		Fiscal 2021		Nine Months ended December 31, 2021	
	(₹ million)	Percentage of Revenue from Operations (%)	(₹ million)	Percentage of Revenue from Operations (%)	(₹ million)	Percentage of Revenue from Operations (%)	(₹ million)	Percentage of Revenue from Operations (%)
International Sales	8,830.04	83.26	7,580.04	83.55	7,255.35	80.33	7,175.29	81.45
Local Deliveries	3,624.06	34.19	2,945.63	32.47	2,547.04	28.20	2,210.78	25.10
Direct Exports	2,480.25	23.36	2,065.04	22.76	2,428.49	26.89	2,743.51	31.14
Warehouse Sales	4,065.13	38.33	3,715.42	40.95	3,713.11	41.11	3,491.67	39.64

In India, we have five manufacturing facilities, two at Ludhiana, Punjab, one at Visakhapatnam, Andhra Pradesh, and two at Noida, Uttar Pradesh. We have also set-up a distribution facility in Noida, Uttar Pradesh. In the United States, we have a manufacturing, warehousing and distribution facility at Eldridge, Iowa, acquired pursuant to our acquisition in 2005 of Olsen Engineering LLC, now known as Uniparts Olsen Inc. (“**UOI**”) and a warehousing and distribution facility at Augusta, Georgia. We have also set up a warehousing and distribution facility in Hennef, Germany, which serves as our base for serving our key European customers. Each of our facilities are strategically located in proximity to several global OEMs in the OHV industry.

We are promoted by first generation entrepreneurs, Gurdeep Soni, our Chairman and Managing Director, and Paramjit Singh Soni, our Executive Director and Vice Chairman, who have over three decades of experience in this business. Our Group Chief Operating Officer, Sudhakar S Kolli and our Non-Executive Director, Herbert Coenen have extensive experience in OHV space having worked with global corporations in the past. Under their leadership we have been able to expand our operations and have established a significant presence in India and globally. We also have a qualified and experienced senior management team that has demonstrated its ability to anticipate and capitalize on changing market trends, manage and grow our operations and leverage and deepen customer relationships. Our management team is strategically located in key end-markets with Paramjit Singh Soni in the United States, Gurdeep Soni and Sudhakar S Kolli in India and Herbert Coenen in Germany.

The following table sets forth certain information relating to certain key financial performance metrics in the periods indicated:

Particulars	As of and for the year ended March 31,			As of and for the nine months ended December 31, 2021
	2019	2020	2021	
Revenue from Operations	10,605.66	9,072.20	9,031.42	8,808.92
EBITDA <sup>(1)</sup>	1,398.48	1,278.10	1,639.26	2,013.48
EBITDA Margin <sup>(2)</sup> (%)	13.19	14.09	18.15	22.86
Restated profit for the year / period	695.97	626.42	923.86	1,223.36
Restated profit for the year / period Margin (%) <sup>(3)</sup>	6.56	6.90	10.23	13.89
Return on Average Equity (“RoAE”) (%) <sup>(4)</sup>	17.68	14.14	18.05	19.97*
Return on Capital	15.37	13.98	19.81	23.14*

Particulars	As of and for the year ended March 31,			As of and for the nine months ended
	2019	2020	2021	December 31, 2021
	(₹ million, except percentages)			
Employed ("RoCE") (%) <sup>(5)</sup>				
Net Debt / EBITDA Ratio	2.36	1.87	0.71	0.63*
Cash Flow from Operations / EBITDA	(0.04)	1.04	0.93	0.18

Notes:

- (1) EBITDA is calculated as restated profit for the year / period plus tax expense plus depreciation and amortization plus finance costs plus exceptional items.
- (2) EBITDA Margin is calculated as EBITDA divided by revenue from operations.
- (3) Restated profit for the year / period margin is calculated as restated profit for the year / period divided by revenue from operations.
- (4) RoAE is calculated as Net profit after tax divided by Average Equity.
- (5) RoCE is calculated as Earnings before interest and taxes (EBIT) divided by Capital Employed.

\* Non-annualised

## STRENGTHS

### *Leading market presence in global off-highway vehicle systems and components segment*

We are a global manufacturer of engineered systems and solutions and are one of the leading suppliers of systems and components for the off-highway market in the agriculture and CFM and aftermarket sectors on account of our presence across 25 countries (*Source: CRISIL Report*). We have a leading presence in the manufacture of 3PL and PMP products globally on account of us serving some of the largest global companies (*Source: CRISIL Report*), including Bobcat, TAFE and Yanmar. We have a presence in key markets worldwide, including North and South America, Europe, Australia, Japan and India. We had an estimated 14.45% market share\* of the global 3PL market in Fiscal 2021 in terms of value and an estimated 5.87% market share\*\* in the global PMP market in the CFM sector in Fiscal 2021 in terms of value.

\* Computed as our 3PL sales in Fiscal 2021 (being USD 45.15 million) divided by the 3PL median market size for calendar year 2020 (being USD 312.5 million) (as per the CRISIL Report).

\*\* Computed as our PMP sales in Fiscal 2021 (being USD 30.52 million) divided by the PMP median market size for calendar year 2020 (being USD 520.0 million) (as per the CRISIL Report).

We have been able to leverage our leadership position and customer confidence to expand into the large construction equipment market, with customers such as Kobelco. We also cover the segment of organized aftermarket and large farm retail stores by servicing our customers including Kramp and TSC. We believe our leading presence in the 3PL and PMP verticals inspires customer confidence in our products, which is expected to fuel our growth going forward.

As per the CRISIL Report, between 2020 and 2025, the global tractor production volume and 3PL market is expected to grow at a CAGR of 6% - 8%. In addition, the demand for PMP products is expected to grow at a CAGR of 7% - 9% between 2020 and 2025, powered by strong volume growth in construction equipment production in key markets such as Japan and Europe (*Source: CRISIL Report*). We are able to leverage our dual-shore manufacturing capabilities to serve customers and address their requirements. The United States government has passed a USD 1 trillion bipartisan plan in November 2021 to rebuild roads and bridges, modernize public works systems and boost broadband internet, among other major improvements to the nation's infrastructure (*Source: CRISIL Report*) and we expect that this will positively affect our growth.

### *Engineering driven, vertically integrated precision solutions provider*

We provide comprehensive solutions and manufacture high-quality, critical products and components for OHV industry. Most of our products are critical, structural and load bearing parts of equipment and are subject to strict tolerances and specifications. A series of precision engineering process steps converge to manufacture these products. We are present across various levels of the OHV component value chain, providing concept-to-supply solutions for our customers. Our offerings include 3PL and PMP and also address adjacent products such as PTO, fabrications and hydraulic cylinders. Our significant backward and forward integration reduces our dependence on external supply and support services and enables maintenance of quality controls required to service global

OEMs and aftermarket players. The table below sets forth details of our revenues based on our product verticals for the periods indicated:

Particulars	Fiscal 2019		Fiscal 2020		Fiscal 2021		Nine Months ended December 31, 2021	
	(₹ million)	Percentage of Revenue from Operations (%)	(₹ million)	Percentage of Revenue from Operations (%)	(₹ million)	Percentage of Revenue from Operations (%)	(₹ million)	Percentage of Revenue from Operations (%)
3PL	5,032.10	47.45	4,279.64	47.17	5,066.55	56.10	4,904.95	55.68
PMP	4,966.97	46.83	4,323.06	47.65	3,397.26	37.62	3,201.70	36.35
PTO applications	94.67	0.89	64.48	0.71	82.14	0.91	90.32	1.03
Fabrication	69.34	0.65	77.18	0.85	84.08	0.93	87.35	0.99
Hydraulic cylinders	12.11	0.11	6.66	0.07	7.87	0.09	4.59	0.05
Others*	430.48	4.06	321.19	3.54	393.51	4.36	520.01	5.90
<b>Total</b>	<b>10,605.66</b>	<b>100.00</b>	<b>9,072.20</b>	<b>100.00</b>	<b>9,031.42</b>	<b>100.00</b>	<b>8,808.92</b>	<b>100.00</b>

\* Others includes scrap sales and export incentive income.

Over the years, we have evolved from a component supplier to a provider of complete assemblies of precision engineered products and end-to-end solutions ranging from product conceptualization, design, prototyping, testing, development and assembly to customized packaging and delivery, becoming an integral part of certain of our customers' global supply chains. As part of our transition from being solely a component manufacturer to solutions provider and further to a systems integrator, we have over the years introduced several products to our product portfolio including rear hitch, front hitch, hydraulic lift arms, PTOs and trailer hitch which allow us to offer integrated system solutions to meet our customer requirements and move up the value chain. We collaborate with our key customers on an on-going basis, on joint product development and process innovation programs, to upgrade and customize our products in tandem with customer specifications and requirements. Collaboration in design and on-site engineering is undertaken during the design and concept stage to suit the end product configuration as well as applicable regulatory requirements. We work jointly with our customers in multiple areas, including product designing, testing and prototyping, which, in turn, helps us in developing long term relationships with them. We deploy a large variety of engineering and manufacturing processes across our manufacturing facilities.

#### **Global business model optimizing cost-competitiveness and customer supply chain risks**

Our global business model serves as an effective solution for customers seeking to rationalize their global sourcing and supply chain by providing them multiple choices in the form of Local Deliveries, Direct Exports and Warehouse Sales, while at the same time helping us to manage costs and increase our margins. We have grown our global business model in a scalable manner, optimized to provide premium-priced Local Deliveries manufactured on-shore in smaller lots and with shorter lead times, as well as cost-competitive offshore deliveries from India with longer lead times and inventory cycles. The table below sets forth our revenues based on our International Sales, Local Deliveries, Direct Exports and Warehouse Sales for the periods indicated:

Particulars	Fiscal 2019		Fiscal 2020		Fiscal 2021		Nine Months ended December 31, 2021	
	(₹ million)	Percentage of Revenue from Operations (%)	(₹ million)	Percentage of Revenue from Operations (%)	(₹ million)	Percentage of Revenue from Operations (%)	(₹ million)	Percentage of Revenue from Operations (%)
International Sales	8,830.04	83.26	7,580.04	83.55	7,255.35	80.33	7,175.29	81.45
Local Deliveries	3,624.06	34.19	2,945.63	32.47	2,547.04	28.20	2,210.78	25.10
Direct Exports	2,480.25	23.36	2,065.04	22.76	2,428.49	26.89	2,743.51	31.14
Warehouse Sales	4,065.13	38.33	3,715.42	40.95	3,713.11	41.11	3,491.67	39.64

In our experience, our India-led manufacturing and overseas-led warehousing coupled with localized customer service capabilities have been a key driver for the growth of our operations. Our global business model also enables us to diversify our margins based on different delivery models for the same product. We maintain inventory in our warehouses which helps mitigate supply chain risks for our customers and reduces long lead time

involved in transit of cargo internationally. We believe, our facilities in India, the United States and Europe are strategically located in proximity to several global OEMs in the OHV industry. We provide timely deliveries tailored to customer specifications in terms of their production schedules, geographical needs, applications, vehicle sizes and technical specifications, and also provide customized packing, warehousing and kitting solutions and logistical support to our customers. We serve our OEM customers from all of our manufacturing, warehousing and distribution facilities, across all our product verticals. OEM sales accounted for 82.21%, 81.12%, 77.31% and 77.31%, respectively, of our revenue from operations in Fiscal 2019, 2020 and 2021, and in the nine months ended December 31, 2021. As part of our offerings to the aftermarket segment, we provide product replacement and add-on parts to end users over the full life cycle of the equipment, after the original purchase is made. Our facility at Noida, Uttar Pradesh serves as a hub for our aftermarket sales globally and our aftermarket sales accounted for 13.68%, 15.06%, 18.89% and 18.57%, respectively, of our revenue from operations in Fiscal 2019, 2020 and 2021 and in the nine months ended December 31, 2021.

Our revenues are diversified across geographies, given our presence in Indian and international markets, across industry sectors and across product verticals. Our global presence has allowed us to deepen our relationships with our customers over time. The table below sets forth details of our revenues based on our key geographies served by us for the periods indicated:

Particulars	Fiscal 2019		Fiscal 2020		Fiscal 2021		Nine Months ended December 31, 2021	
	(₹ million)	Percentage of Revenue from Operations (%)	(₹ million)	Percentage of Revenue from Operations (%)	(₹ million)	Percentage of Revenue from Operations (%)	(₹ million)	Percentage of Revenue from Operations (%)
Americas	5,959.74	56.20	5,189.85	57.21	4,349.15	48.16	4,080.77	46.33
Europe	1,916.45	18.07	1,650.28	18.19	2,106.30	23.32	2,231.01	25.33
India	1,339.40	12.63	1,146.04	12.63	1,433.28	15.87	1,270.67	14.42
Japan	484.72	4.57	420.77	4.64	408.30	4.52	409.07	4.64
Asia-Pacific	219.64	2.07	166.78	1.84	169.28	1.87	180.84	2.05
Rest of the world	249.50	2.35	152.37	1.68	222.33	2.46	273.59	3.11
<b>Total</b>	<b>10,169.45</b>	<b>95.89</b>	<b>8,726.09</b>	<b>96.18</b>	<b>8,688.64</b>	<b>96.20</b>	<b>8,445.96</b>	<b>95.88</b>

Our ability to service multiple customer locations across the globe helps our customers in managing their vendor base. This also assists us in expanding our business with our existing customers and work with them across various end equipment segments as well as multiple geographies. We work with a number of global customers from whom we service different business divisions and supply to several manufacturing facilities globally.

***Long-term relationships with key global customers, including major OEMs, resulting in a well-diversified revenue base***

We have developed long-term relationships with global customers in the agriculture and CFM sectors, such as TAFE, Claas Tractors and Kramp. Four of our top five customers (based on contribution to our revenue from operations during Fiscal 2021) have been our customers for over 10 years. TAFE and Kramp are some of the customers with whom we have had relationships for over 15 years, while with customers like Yanmar, we have developed relationships for over 10 years. Customers we acquired in 2017 onwards, accounted for 4.80%, 6.97%, 11.13% and 9.62%, respectively, of our revenue from operations in Fiscal 2019, 2020 and 2021 in and the nine months ended December 31, 2021, with one such customers being a part of our top three customers by revenue in Fiscal 2021 reflecting our ability to develop and strengthen relationships with customers.

The table below sets forth details of our revenues based on sales to our OEM customers in the agriculture and CFM sectors for the periods indicated

Particulars	Fiscal 2019		Fiscal 2020		Fiscal 2021		Nine Months ended December 31, 2021	
	(₹ million)	Percentage of Revenue from Operations (%)	(₹ million)	Percentage of Revenue from Operations (%)	(₹ million)	Percentage of Revenue from Operations (%)	(₹ million)	Percentage of Revenue from Operations (%)
Agriculture	6,425.61	60.59	5,441.55	59.98	6,303.79	69.80	6,224.05	70.66

Particulars	Fiscal 2019		Fiscal 2020		Fiscal 2021		Nine Months ended December 31, 2021	
	(₹ million)	Percentage of Revenue from Operations (%)	(₹ million)	Percentage of Revenue from Operations (%)	(₹ million)	Percentage of Revenue from Operations (%)	(₹ million)	Percentage of Revenue from Operations (%)
segment								
CFM segment	3,711.88	35.00	3,244.63	35.74	2,372.66	26.26	2,181.45	24.74

We have wide and deep relationships with our key OEM customers. Over the years, for various OEM customers, we have developed relationships and received orders from multiple business divisions and locations globally, including through our efforts to cross sell different products to our global OEM customers. Our manufacturing, designing and testing capabilities coupled with the capability to leverage our global business model has helped us develop and maintain long-term relationships with a number of our customers. Our relationship with global OEM customers will enable us to access a corresponding share of the OHV market in the future. We have been recognized by our customers as a key supplier and were awarded the “Most Versatile Supplier 2020” by Kubota India. We believe that our entrenched relationship with our customers resulting from our global business model, dual-shore manufacturing, along with the criticality, volume and type of components we supply to them act as effective barriers to entry for other suppliers.

We have a well-diversified customer base and our reliance on any single customer is limited. Our single largest customer generated ₹ 4,204.89 million, ₹ 3,345.33 million, ₹ 3,084.25 million and ₹ 2,878.45 million in revenues and accounted for 39.65%, 36.87%, 34.15% and 32.68% of our revenue from operations in Fiscal 2019, 2020 and 2021, and in the nine months ended December 31, 2021, respectively. In addition, sales to our top five customers were ₹ 6,469.91 million, ₹ 5,550.43 million, ₹ 5,267.19 million and ₹ 4,923.02 million and accounted for 61.00%, 61.18%, 58.32% and 55.89% of our revenue from operations in Fiscal 2019, 2020 and 2021, and in the nine months ended December 31, 2021, respectively, while sales to our top 10 customers were ₹ 8,022.13 million, ₹ 6,769.73 million, ₹ 6,600.07 million and ₹ 6,230.21 million and accounted for 75.64%, 74.62%, 73.08% and 70.73% of our revenue from operations, respectively, in such periods. In our view, the strength of our customer relationships is attributable to our ability to customize to customer specifications and requirements, as well as our track record of consistent delivery of quality and cost-effective products and solutions through our strategic alignment with our key customers’ goals and specifications over the years.

Our customers have unique requirements and preferences. We partner with our key customers at various stages of product development, commencing from product design, through validation and testing up to final manufacturing and delivery, and we seek to capitalize on our existing customer base to achieve cross-selling of our products across our business verticals. This also helps us understand customer requirements and future plans better, enabling us to forecast, plan and manufacture our products accordingly, thereby resulting in business optimization, improved productivity, efficiency and margins.

#### ***Strategically located manufacturing and warehousing facilities that offer scale and flexibility***

As on the date of this Draft Red Herring Prospectus, we operate six strategically located manufacturing facilities spread across India and the United States. As on December 31, 2021, our aggregate installed capacity across these manufacturing facilities was 66,940 metric tonne per annum. Our dual-shore capabilities, which is our ability to undertake manufacturing products at different locations, allow us to service customer requirements from alternate locations, providing customers the benefit of regular supply and cost-competitive manufacturing operations.

Over the years, we have built significant in-house end-to-end manufacturing process capabilities and expertise ranging from a forge shop, precision machining on computer numerical control (“CNC”) and vertical machining center (“VMC”), welding (including butt and robotic welding), induction hardening, grinding, thread rolling, hobbing, broaching, shot blasting, heat treatment (continuous furnace, pit furnace and sealed quench furnace), surface finishing (including plating and painting) and electrophoretic deposition (“ED”) coating amongst others.

Our shop floor capabilities coupled with our design and testing capabilities (including test rig with capability of up to 400 kilonewton enabling testing for high horse power tractor segment) enable us to serve as a comprehensive solutions provider for the precision engineering product requirements of our customers. We believe with continued investments in our facilities and capabilities, we have been able to develop an efficient, technology-driven manufacturing process that has helped us to manufacture our products in accordance with the requirements and specifications of our customers in a cost-effective manner.

Over the years, we have focused on creating robust manufacturing systems and processes. Our manufacturing facilities have been certified for conforming to and applying international standards of quality management systems and we have comprehensive tooling, testing and quality control infrastructure. Our facility in the United States is ISO 9001:2015 certified while all our Indian facilities are also ISO 14001:2015 certified. We also adhere to global standards for health and safety and environment management, and have obtained various global certifications. This ensures that our processes comply with customer specific, industry specific, statutory health and safety, as well as environmental and social and governance requirements. For further information, see “ – **Quality Control, Environment and Occupational Health and Safety**” on page 170.

We also have three international warehousing facilities in Germany and the United States. Our presence in these locations allows us to service and grow in these markets more efficiently by becoming a local supplier to global OEMs. Proximity to our key customer groups provides us with a strategic advantage in ensuring cost effectiveness, quicker delivery and faster turnaround times. In our experience, our presence across geographies has enabled us to diversify our revenues and also enhanced our position as a global supplier.

### ***Strong financial position with robust financial performance metrics***

Over the years, our revenue from operations have remained stable despite the impact of the COVID-19 pandemic on our business operations. Our revenues from operations were ₹ 10,605.66 million, ₹ 9,072.20 million, ₹ 9,031.42 million and ₹ 8,808.92 million in Fiscal 2019, 2020 and 2021 and in the nine months ended December 31, 2021, respectively.

Our EBITDA was ₹ 1,398.48 million, ₹ 1,278.10 million, ₹ 1,639.26 million and ₹ 2,013.48 million in Fiscal 2019, 2020 and 2021 and in the nine months ended December 31, 2021, respectively, while our EBITDA margin was 13.19%, 14.09%, 18.15% and 22.86%, respectively, for such periods. Our restated profit for the year / period was ₹ 695.97 million, ₹ 626.42 million, ₹ 923.86 million, ₹ 1,223.36 million in Fiscal 2019, 2020 and 2021 and in the nine months ended December 31, 2021, respectively while our restated profit for the year / period margin was 6.56%, 6.90%, 10.23% and 13.89%, respectively, for such periods. As of March 31, 2019, 2020 and 2021 and as of December 31, 2021, our RoCE was 15.37%, 13.98%, 19.81% and 23.14% (non-annualized), respectively, while our RoAE was 17.68%, 14.14%, 18.05% and 19.97% (non-annualized), respectively.

We have a strong balance sheet position with net worth of ₹ 6,659.62 million as of December 31, 2021 and have been able to maintain a low debt position. As of March 31, 2019, 2020 and 2021 and as of December 31, 2021, our debt equity ratio was 0.78, 0.52, 0.21 and 0.19, respectively. We have prudently utilized our resources, which has enabled us to fund our capital expenditure through internal accruals and have been able to reduce our total debt. Further our net debt to EBITDA ratio was 2.36, 1.87, 0.71 and 0.63 (non-annualized), as of March 31, 2019, 2020 and 2021 and as of December 31, 2021, respectively.

We believe that our operating leverage, which impacts our EBITDA margins and cash flow generation, is driven by our efficient business model which promotes continuity in cash flows. Our net cash flow from / used in operating activities was ₹ (56.51) million, ₹ 1,330.67 million, ₹ 1,527.55 million, and ₹ 354.43 million, in Fiscal 2019, 2020 and 2021 and in the nine months ended December 31, 2021, respectively. We expect that our strong operational and financial performance will allow us to capitalize on the strong tailwinds in the engineering solutions industry.

### ***Experienced Promoters and qualified senior management team***

We benefit significantly from our experienced management and technical teams, including, in particular, our Promoter and Chairman and Managing Director, Gurdeep Soni, who is in charge of our aftermarket business, our Promoter and one of our Executive Directors and Vice Chairman, Paramjit Singh Soni, who is in charge of OEM business, inorganic growth and strategic initiatives, who each have over three decades of experience in this business. Our Group Chief Operating Officer, Sudhakar S Kolli, is in charge of our overall operations, business development and marketing and has over 25 years of experience in the areas including general management with leadership role and operations and product development. One of our Directors, Herbert Coenen, is in charge of business development, marketing and technology advancement has more than 35 years of experience in the international OHV market, and in the industry and the markets in which we operate. Our management team is strategically located in key end markets with Paramjit Singh Soni in the United States, Gurdeep Soni and Sudhakar S Kolli in India and Herbert Coenen in Germany. Our senior management has extensive experience in operations, business development and quality, customer relationship and human resource management and have held leadership positions with multinational corporations. For further information on our management and key

managerial personnel, see “*Our Management – Brief Profiles of our Directors*” and “*Our Management – Key Managerial Personnel*” on pages 191 and 204, respectively.

Our management and technical personnel are supported by other skilled workers who benefit from regular in-house and onsite training initiatives. As of December 31, 2021, we had 180 full-time employees having engineering degrees while 169 others are technical diploma holders and 88 have other professional qualifications. Our personnel policies are aimed towards recruiting talented individuals, facilitating their integration, and promoting the development of their skills. In addition to regular compensation, statutory benefits and standard insurance coverage, we have one employee stock option plan designed to motivate and incentivize our employees.

## **STRATEGIES**

### ***Leverage integrated precision engineering capabilities and established global business model, to tap additional business opportunities and expand addressable market***

The global 3PL market is estimated to be between USD 430 million and USD 450 million in 2025. Tractor demand from North America and Europe, the two important 3PL markets contributing close to 45% of world demand, is estimated to grow at a CAGR of around 6% - 9% between 2020 and 2025. The global market for PMP for articulated joints was USD 520 million in 2020, with 80% and above of the demand from four key geographies China, Japan, Europe and North America. (*Source: CRISIL Report*) We have established an end-to-end and scalable business model which caters to a number of requirements of our customers in the OHV market. We intend to leverage our manufacturing and warehousing infrastructure, global footprint and value proposition to expand further in newer geographies, adjacent product verticals, acquire additional customer accounts as well as increase wallet share among our existing customers. We intend to achieve this by focussing on increasing the share of customer spend per vehicle by manufacturing additional 3PL products for more than 60 horsepower vehicles, PMP products for large construction equipment, fabrication solutions such as agriculture implements and construction attachments, and new PTO applications. We are also actively exploring adjacent vehicle and equipment types such as utility task vehicles and all-terrain vehicles where we have developed prototypes of system solutions that are currently in trial phase. We believe there are opportunities for these solutions both in the aftermarket segment as well as with OEMs.

We further believe that there exist significant opportunities to cross-sell our products and offer the same product to additional locations of our existing customers with the help of our established capabilities and manufacturing, warehousing and distribution infrastructure. We have multiple such global customers wherein we service their different business divisions, several manufacturing plants in multiple global geographies.

Our experience in servicing aftermarket customers and large retail store chains provides us with additional opportunities in large adjacent product spaces and in particular in agriculture segment.

### ***Focus on higher value addition products and enhanced service offerings to improve the margin profile***

We continually evaluate product and service opportunities enabling movement towards higher value-addition and improving margin profile of our revenue portfolio. Our EBITDA margins have increased from 13.19% in Fiscal 2019, to 14.09% in Fiscal 2020 and to 18.15% in Fiscal 2021. Further, in the nine months ended December 31, 2021, our EBITDA margins was 22.86%. We endeavour to ensure that new business opportunities are margin accretive. We intend to continue to increase the proportion of our warehousing sales in our overall sales model mix, as this delivery model carries premium and is margin accretive. We regularly evaluate existing manufacturing portfolio as well and undertake calibrated relocation of manufacturing any identified products to optimize cost structure and resulting margins. As part of our strategy of improving the margin profile of our portfolio, we intend to further expand our product portfolio with solutions for adjacent vehicle and equipment types such as utility task vehicles and all-terrain vehicles as well as focus on PMP products with a technology focus, such as, plungers and transmission components.

### ***Target new customer accounts and expand existing customer accounts***

We intend to increase our sales and customer penetration by targeting new customer accounts and expanding our existing customer accounts in our principal markets by offering our entire range of products. Customers we acquired in 2017 onwards, accounted for 4.80%, 6.97%, 11.13% and 9.62%, respectively, of our revenue from operations in Fiscal 2019, 2020 and 2021 and the nine months ended December 31, 2021. We intend to continue to consolidate and develop our relationships with large and renowned global OEMs whose product portfolios are

spread across industries such as agriculture, CFM and industrial equipment, as well as our value engineering and process innovation competencies so as to be able to enter new and related markets and acquire, evolve and strengthen our customer relationships. We intend to offer our customers additional 3PL and PMP products to meet our customers' requirements and thereby growing our share of customers' spend per vehicle. In particular, we believe that the CFM sector offers us the opportunity to target new customers for our products. Between 2021 and 2025, growth is expected to be driven by North America, Europe and India due to higher expected investment in infrastructure projects (*Source: CRISIL Report*). We believe that we will be able to capitalize on our reputation for quality, consistent performance and customer satisfaction in our existing markets and product verticals to target new customers.

### ***Enhance engineering, innovation and design competence***

We endeavor to focus on process and product innovation and value engineering solutions in order to meet the requirements of a wider range of vehicles, geographies, applications and other customer specifications, so as to strengthen and diversify our customer and product portfolio. Towards this objective, we seek to continue to improve our in-house value engineering, testing, design and process innovation capabilities through human resource and technical development, as well as exploring opportunities for collaboration and inorganic growth and continuing to work closely with our key customers to upgrade and customize our products, in particular, to increase sales of 3PL products in the higher horsepower (more than 60HP) tractor segment and of PMP, hydraulic cylinders and PTO applications, while maintaining and improving our market share in the 3PL and PMP verticals.

### ***Grow inorganically through strategic acquisitions and alliances***

We intend to continue our strategy to explore opportunities for forward integration, including selectively evaluating targets for strategic acquisitions and investments, in order to strengthen our position as an integrated, full system solutions provider for the agriculture and CFM sectors. Through this objective we seek to strengthen our product platform and customer portfolio.

We have in the past benefited from our strategic acquisition in 2005 of UOI, which catalyzed the growth of our PMP product vertical and our sales to the CFM sector. In addition, our investment in Kavee (a joint venture with Kramp, a long-term customer that we continue to supply to), which ceased to be our subsidiary with effect from April 1, 2012, also contributed significantly to our acquisition of product and process knowledge for our hydraulic cylinders vertical.

We intend to focus on acquiring businesses with high growth and performance potential, along with their existing customer relationships and product and process competencies, and to integrate and grow their businesses through enhanced quality and delivery parameters, engineering support, integration of IT systems and ERP platforms with manufacturing support from India, coupled with our management know-how and experience. While we will also evaluate any opportunistic acquisitions that are viable, our primary strategy is to focus on identifying financially stable and performing assets for acquisition. In particular, we intend to explore opportunities in Europe, which would give us a manufacturing base in the continent, as well as opportunities in the United States to complement our existing business. We may also seek to expand our international warehousing and distribution operations, based on demand and delivery logistics in various geographies, to fuel our growth going forward. We believe that we have been successful in acquiring and integrating overseas assets and ventures in the past and will continue to benefit from such initiatives, thereby expanding our product portfolio, market share, customer base and geographical footprint.

## **BUSINESS OPERATIONS**

### **Products and Solutions**

We manufacture products under two core product verticals 3PL and PMP. We also manufacture products for adjacent product verticals that include hydraulic cylinders, PTOs and fabrications.

### ***3PL***



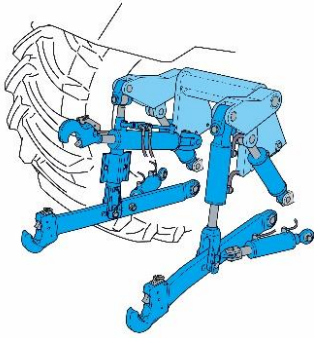

The 3PL system forms a group of assemblies allowing an implement like a plough to be attached to the tractor at three coupling points, forming a triangle. Most tractors are equipped with a 3PL system and are classified according to International Organization for Standardization (“ISO”) 730 in four categories, based on the engine rating. The 3PL transfers the entire load, which can be a multiple of the implement weight, between the tractor and implement. The parts are highly loaded and exposed to fatigue as well as wear and tear, in particular in the joints, due to movement under high load condition. The primary function of the 3PL is to transfer the weight and load of an implement to the wheels of a tractor and to allow the adjustment of different positions by lifting and lowering the implement.

### 3PL Systems

The 3PL comprises different parts:

- Two lower arms called draft link or lower link, forming two out of the three coupling points;
- Two lift rods connecting the two lower links with two lift arms, which are not part of the 3PL but form part of the hydraulic lift. The hydraulic lift is powered and allows lowering and lifting of the 3PL;
- One top link or center link, acting as a connecting rod and forming the third coupling point; and
- Stabilizer systems controlling the lateral movement of the lower links.

The design of a 3PL and its integration into the tractor is tractor specific, and each tractor model has its own design features in terms of geometry, size, and features, and each model can be equipped by the tractor manufacturer with different configurations based on final point of use. The geometry and size in terms of cross sections used is not only dependent on the engine rating and expected loads to be transferred, but also largely dependent on the design of the transmission, rear axle and tyres to be used. The 3PL has to interface with these boundary conditions and has to fit to the connecting points of the tractor, which are not standardized in any form.

The features of a 3PL design are highly dependent on the market that it serves. The design features of a 3PL can be broadly classified as follows:

- *Standard:* Basic design of all components with simple joints to connect the implement to the tractor, used on low horsepower tractors and in the economy segment.
- *Telescopic:* In this design, the lower links do not have standard ball joints at the interfacing joining the implement, but a device allowing the slip end to be disengaged and then joined to the implement by having the tractor positioned in a certain proximity to the implement. In this configuration, the top link is usually a standard design with basic ball joints at the implement end.
- *Quick Coupler:* The lower links are equipped with a claw allowing the operator to remain in the operator station and to connect or disconnect an implement from the operator station, which has significant advantages with regard to safety and comfort, in particular considering the size and weight of implements connected to a tractor.
- *Frame Coupler:* This is a version of a quick coupler using a frame/single piece joined with the implement. This configuration is primarily a North American specification.

### 3PL – Manufacturing Facilities

We have four manufacturing facilities in India, producing 3PL. Our two Noida, Uttar Pradesh facilities serve as our hub for the domestic market and also serves export customers. Our Visakhapatnam, Andhra Pradesh facility primarily serves export customers. Our SKG, Ludhiana, Punjab facility primarily serves the Indian domestic 3PL market.

### 3PL – Manufacturing Process

Our manufacturing processes range from pre-machining processes like die-forging, upset-forging, pressing, punching, bending and cold drawing to machining processes performed on conventional or CNC equipment for turning, milling, thread rolling and cutting, spline rolling, grinding as well as laser cutting, welding, heat treatment, surface finishing and assembly. The heat treatment process varies depending on customer specifications and intended applications. For instance, we apply through hardening on all structural parts to increase the implement’s load carrying capability; we apply case carburizing on parts that are in the joints and exposed to wear

and tear; and we apply induction hardening to achieve higher case depth in combination with high tensile strength material to have high load bearing capability along with wear resistance. Most of our products in this vertical are supplied in painted condition. Among other capabilities, we also offer finished products, ED coated and painted, as well as powder coated products.

## **PMP**

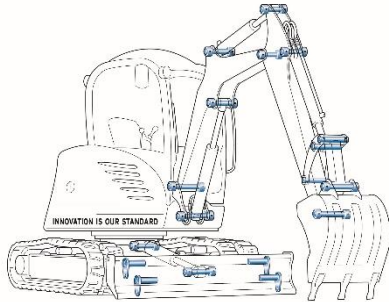

### **PMP in articulated joints**

products, they lack standardization and the number of variants in this product vertical is very high.

PMP is a group of components that require stringent material and manufacturing specifications and controls, used in applications across OHVs, ranging from engine parts and transmission components to particular parts for joints in agricultural and construction applications. Of our construction PMPs, the majority is used in articulated joints (hinges) where arms, booms and cylinders are attached to each other. These articulated joints are the single largest application of PMP for us. The size varies in terms of weight from less than 1kg per part to more than 100kg per part depending on the application we service. One of the key differences of this product range as compared to 3PL is that PMP parts are predominantly individual parts with significant load bearing capability and not a complete assembly of multiple parts, as compared to a 3-point linkage system comprising of multiple assemblies. Due to the complex design and high degree of precision required in PMP

### *PMP – Manufacturing Facilities*

We have four manufacturing facilities producing PMP in India, one at Visakhapatnam, Andhra Pradesh and Farmparts, Ludhiana, Punjab, and two at Noida, Uttar Pradesh. In addition, our facility at Eldridge, Iowa, United States (“**Eldridge facility**”) serves the North American market, with local production as well as warehousing of products manufactured in and exported from India.

### *PMP – Manufacturing Process*

The standard production process for PMP products ranges from precision machining (on CNC or VMC or conventional machines), heat treatment and grinding, followed by welding, if required, and finishing operations such as hardening and plating. The raw material used in the PMP products primarily includes steel bars, steel plates. The manufacturing process parameter for PMP products is subject to strict tolerances and quality controls.

### *Hydraulic Cylinders*

Hydraulic cylinders are used as actuators to move mechanized components, by generating linear motion along an axis. Hydraulic cylinders are powered by a fluid, typically oil. Hydraulic cylinders may be ‘double acting’ hydraulic cylinders, which are powered to extend or reduce the length, or ‘single acting’ hydraulic cylinders, which are only powered to move in one direction. Plunger cylinders form a subcategory of single acting cylinders, using the rod as a piston, where the rod is only slightly smaller than the inner diameter of the tube.

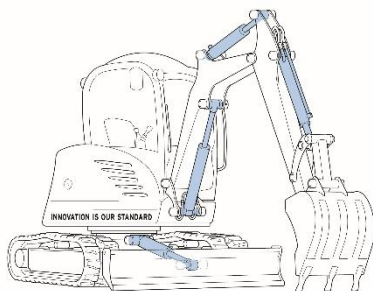

Although all or several of our customers possess in-house competence for manufacturing hydraulic cylinders, we believe that there is still significant demand, in particular in international markets, for hydraulic cylinders due to increased mechanization and transitions in technology, and that the following factors have led to that trend:

- Size and weight of equipment;
- Complexity of equipment and the application;
- Comfort; and
- Safety.

### *Hydraulic Application*

We seek to focus on applications that are synergetic to our existing applications and existing customers. An example for synergies with existing activities are hydraulic top links, which are a special design used in the 3PL

application by the aftermarket as a retro fit and also by OEMs in lieu of mechanical top links. Another example is lift cylinders, which are used in the hydraulic lift of a tractor. In addition, many of our PMP applications interface with cylinders. We believe that the development of such synergetic products allows us not only to enter the hydraulic segment but also to extend our market share in our existing 3PL and PMP verticals. Our increasing diversification into the hydraulic cylinders vertical is part of our strategy to increase our content and customer spend per vehicle.

#### *Hydraulic Cylinders – Manufacturing Facilities*

We have hydraulic cylinder manufacturing capabilities at our Visakhapatnam, Andhra Pradesh facility, to serve our customers.

#### *Hydraulic Cylinders – Manufacturing Process*

The manufacturing process is split into machining, including turning, milling and welding (where standard machines are used, fine-tuned to cater to the length of the component), followed by assembly and testing. Hydraulic cylinders are required to qualify for cleanness requirements, including assembly in a clean room and testing and painting.

#### **PTO**



#### *PTO Application*

PTO is a device used to drive implements such as rotary tillers, mowers and other equipment requiring a mechanical drive by the tractor. The PTO transmits power from the tractor to the implement and is used to distribute the power within the machine. The PTO is implement-specific and part of the implement and, therefore, each implement has one main shaft and, in many cases, secondary shafts to distribute the power within the implement. We are currently focused on producing PTO for the agriculture sector, which allows the transfer of power from the tractor to the implement. This product is a low-speed shaft used at standard speeds ranging between 540 rpm and 1,000 rpm. It comprises four functional groups:

- two joints – one at each side;
- telescopic members connected to the joints, allowing the shaft to change its length during operation;
- overload clutch to protect the implement and tractor from damage; and
- safety guard to protect the operator and to avoid any material from getting wound around the shaft.

The design and features of PTO used for agricultural purposes are different from PTO shafts used in commercial truck or industrial applications. They differ in operating speed, joint design, design of telescopic members and the guard, which is mandatory, and are required to comply with international safety norms. The initial applications are rotavators, reapers, pumps and threshers. According to ISO standards, PTOs are classified into different sizes and power ratings specifying the power and torque that they are able to transmit.

#### *PTO – Manufacturing Facilities*

We manufacture PTO components at our Farmparts, Ludhiana, Punjab facility as well as at our facility located at B-208, Noida, Uttar Pradesh for OEMs as well as for sale in the aftermarket.

#### *PTO – Manufacturing Process*

The production processes involved include turning and milling of castings and forgings used in joints and flanges,

followed by broaching and hobbing. The machining of components is followed by painting and assembly with a guarding shielding all rotating items which prevent accidents.

### ***Fabrications***



Agriculture as well as construction equipment use fabrications ranging from large structural parts and chassis to small and medium in size with no chassis parts. These parts vary in terms of size as well as design specifications and manufacturing process complexity. These parts can be high on metal content (primarily steel) and also utilize processes such as bending, welding and surface finishing. The design of such parts typically varies and is dependent on the type of vehicle and OEM's specifications. Examples of fabrication parts include hitch frames, A-frames, front-end loader parts, grain lifters and engine frames. Our current focus is on applications and products which are not produced by our customers in-house. These products such as trailer hitches, front hitch components, engine frame, grain lifter and front end loader parts are synergetic to products and vehicles we currently service.

### ***Fabrication – Manufacturing Facilities***

We primarily manufacture fabrication components at our SKG facility at Ludhiana, Punjab for OEMs as well as for sale in the aftermarket segment.

### ***Fabrication – Manufacturing Process***

The key manufacturing processes involved are cutting, bending, welding and surface finish. Welding is performed both on robotic welding and regular welding. In order to service the demand and expand our offerings in this product vertical, we have extended our capacity as well as capability by adding processes such as surface finish by way of a new painting line to supply parts with a superior finish.

The table below sets forth details of sales of finished goods across market segments, product verticals and geographies for the periods indicated:

Particulars	Fiscal 2019		Fiscal 2020		Fiscal 2021		Nine Months ended December 31, 2021	
	(₹ million)	Percentage of Revenue from Operations (%)	(₹ million)	Percentage of Revenue from Operations (%)	(₹ million)	Percentage of Revenue from Operations (%)	(₹ million)	Percentage of Revenue from Operations (%)
<b>Revenue split across market segment</b>								
Agriculture segment	6,425.61	60.59	5,441.55	59.98	6,303.80	69.80	6,224.05	70.66
CFM segment	3,711.88	35.00	3,244.63	35.76	2,372.66	26.27	2,181.45	24.76
Others	31.95	0.30	39.12	0.43	12.18	0.13	40.46	0.46
<b>Revenue split across product vertical</b>								
3PL	5,032.10	47.45	4,279.64	47.17	5,066.55	56.10	4,904.95	55.68
PMP	4,966.97	46.83	4,323.06	47.65	3,397.26	37.62	3,201.70	36.35
PTO applications	94.67	0.89	64.48	0.71	82.14	0.91	90.32	1.03
Fabrication	69.34	0.65	77.18	0.85	84.08	0.93	87.35	0.99
Hydraulic cylinders	12.11	0.11	6.66	0.07	7.87	0.09	4.59	0.05
Others*	430.48	4.06	321.19	3.54	393.51	4.36	520.01	5.90
<b>Revenue split across geographies</b>								

Particulars	Fiscal 2019		Fiscal 2020		Fiscal 2021		Nine Months ended December 31, 2021	
	(₹ million)	Percentage of Revenue from Operations (%)	(₹ million)	Percentage of Revenue from Operations (%)	(₹ million)	Percentage of Revenue from Operations (%)	(₹ million)	Percentage of Revenue from Operations (%)
Americas	5,959.74	56.20	5,189.85	57.21	4,349.15	48.16	4,080.77	46.33
Europe	1,916.45	18.07	1,650.28	18.19	2,106.30	23.32	2,231.01	25.33
India	1,339.40	12.63	1,146.04	12.63	1,433.28	15.87	1,270.67	14.42
Japan	484.72	4.57	420.77	4.64	408.30	4.52	409.07	4.64
Rest of the world	249.07	2.35	152.37	1.68	222.33	2.46	273.59	3.11
Asia-Pacific	219.64	2.07	166.78	1.84	169.28	1.87	180.84	2.05

\* Others includes scrap sales and export incentive income.

The table below sets forth our geography-wise revenue across product segments for the periods indicated:

Particulars	Fiscal 2019		Fiscal 2020		Fiscal 2021		Nine Months ended December 31, 2021	
	(₹ million)	Percentage of Revenue from Operations (%)	(₹ million)	Percentage of Revenue from Operations (%)	(₹ million)	Percentage of Revenue from Operations (%)	(₹ million)	Percentage of Revenue from Operations (%)
<b>Americas</b>								
3PL	1,883.85	17.76	1,832.04	20.19	1,898.14	21.02	1,814.37	20.60
PMP	4,034.15	38.04	3,348.00	36.90	2,401.86	26.59	2,126.85	24.14
PTO applications	48.28	0.46	31.76	0.35	21.30	0.24	35.77	0.41
Fabrication	1.98	0.02	-	0.00	0.91	0.01	1.06	0.01
Hydraulic cylinders	8.15	0.08	4.54	0.05	6.84	0.08	4.59	0.05
<b>Europe<sup>(1)</sup></b>								
3PL	1,312.09	12.37	1,060.19	11.69	1,395.06	15.45	1,399.97	15.89
PMP	503.81	4.75	491.95	5.42	554.10	6.14	639.94	7.26
Fabrication	38.27	0.36	58.44	0.64	73.33	0.81	79.92	0.91
PTO applications	44.58	0.42	32.43	0.36	57.74	0.64	53.36	0.61
<b>India</b>								
3PL	1,291.33	12.18	1,038.61	11.45	1,306.82	14.47	1,173.19	13.32
PMP	23.58	0.22	90.72	1.00	115.02	1.27	92.02	1.04
Fabrication	29.08	0.27	18.74	0.21	9.84	0.11	6.37	0.07
PTO applications	0.52	0.00	-	-	2.05	0.02	-	-
<b>Japan</b>								
PMP	309.59	2.92	300.98	3.32	289.60	3.21	290.27	3.30
3PL	176.65	1.67	121.73	1.34	119.80	1.33	119.20	1.35
<b>Asia-Pacific<sup>(2)</sup></b>								
3PL	174.79	1.65	113.92	1.26	154.86	1.71	159.20	1.81
PMP	44.89	0.42	54.96	0.61	10.58	0.12	21.64	0.25
PTO applications	0.02	0.00	-	-	-	-	-	-
<b>Rest of the world<sup>(3)</sup></b>								
3PL	193.39	1.82	113.15	1.25	191.87	2.12	239.01	2.71
Hydraulic cylinders	3.96	0.04	2.11	0.02	1.03	0.01	-	-
PMP	50.94	0.48	36.46	0.40	26.10	0.29	30.98	0.35
PTO applications	1.27	0.01	0.29	0.00	1.05	0.01	1.19	0.01

Notes:

- (1) Europe includes Austria, Belgium, Czech Republic, Denmark, France, Germany, Hungary, Ireland, Italy, Netherlands, Poland, Spain and United Kingdom
- (2) Asia-Pacific includes China, Indonesia, Israel, Korea, Thailand, Turkey and Yemen
- (3) Rest of the world includes Australia, Brazil, Mexico, New Zealand, South Africa and Zambia

## Operations

Our growth model has been based on our evolution from being a supplier of components into now being an integrated provider of complete product assemblies and systems, and concept-to-supply solutions across the OHV component value chain, as well as being a dual-shore manufacturer and supplier of engineering systems, solutions, assemblies and components to global OEM customers, based on a process of continuing vertical and horizontal integration, while at the same time using our traditional aftermarket access to wholesalers and distributors and expanding it with warehousing services to service retail chains directly.

The schematic below sets out our presence across the concept-to-supply solutions value chain.

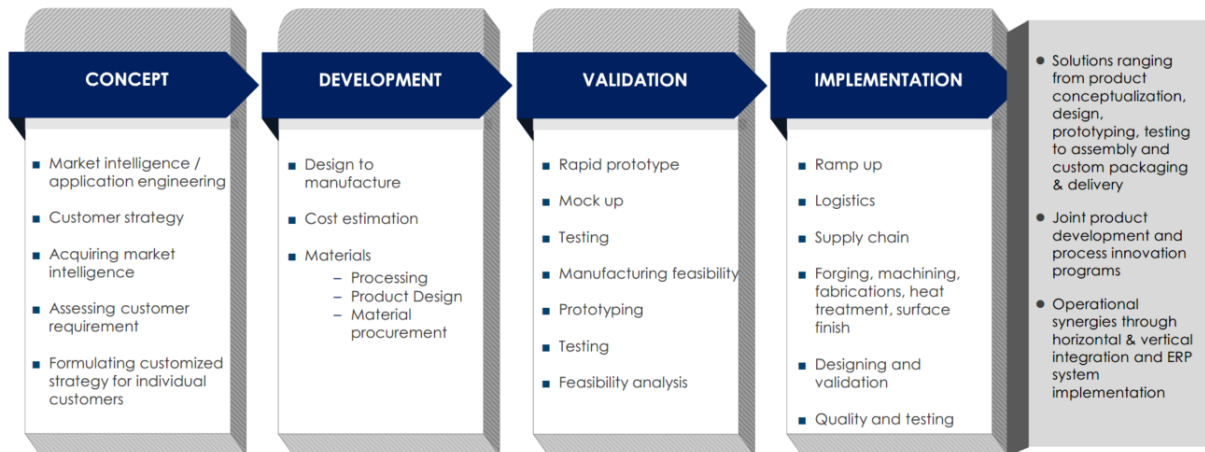

We offer fully integrated engineering solutions from conceptualization, development and validation to implementation and manufacturing. The conceptualization stage involves acquiring market intelligence, assessing customer requirement and formulating customized strategy for individual customers. The development phase includes product designing, material procurement and processing. This is followed by the validation phase, which involves prototyping, testing and feasibility analysis. Our in-house manufacturing and implementation competencies include forging, machining, fabrications, heat treatment, surface finish, logistics, quality and testing, design and validation.

OEM sales accounted for 82.21%, 81.12%, 77.31% and 77.31%, respectively, of our revenue from operations in Fiscal 2019, 2020 and 2021, and in the nine months ended December 31, 2021. Sales to our top 10 customers accounted for 75.64%, 74.62%, 73.08% and 70.73% of our revenue from operations in Fiscal 2019, 2020 and 2021, and in the nine months ended December 31, 2021, respectively. We serve our OEM customers from all of our manufacturing, warehousing and distribution facilities, across all our product verticals. We believe that over the years, we have strengthened our customer engagement with key OEM customers and offered them multiple products across multiple locations.

Aftermarket involves providing product replacement (due to wear and tear) and certain add-on parts to the end user over the full life cycle of the equipment, after the original purchase is made. Within the aftermarket category, we are focused on the ‘will-fit’ parts segment, sold to distributors like Kramp as well as retail store chains such as TSC. Aftermarket sales accounted for 13.68%, 15.06%, 18.89% and 18.57%, respectively, of our revenue from operations in Fiscal 2019, 2020, 2021 and in the nine months ended December 31, 2021. One of our Noida, Uttar Pradesh facility operated by GFPL serves as a hub for our aftermarket sales in the United States, Europe, South Africa and Australia. The aftermarket customers are serviced through Direct Exports and Warehouse Sales.

### ***Global Business Model***

The chart below illustrates our dual-shore multiple delivery model:

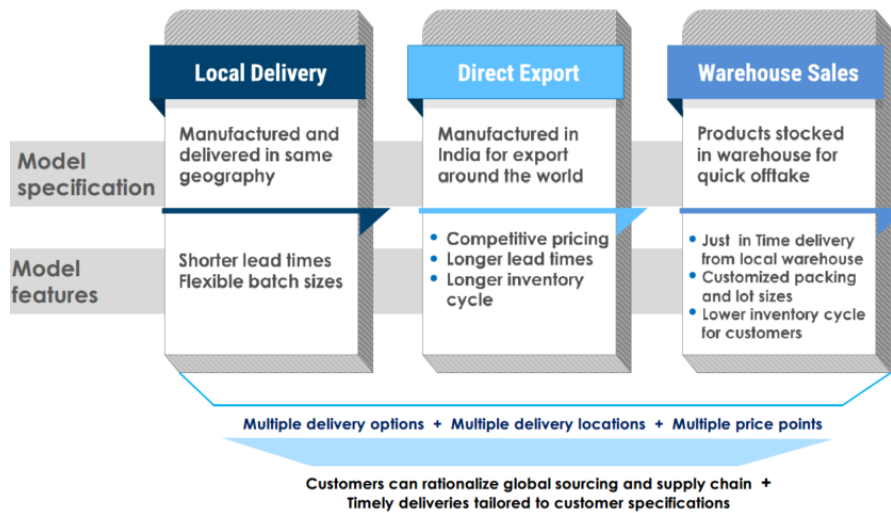

Our global business model has contributed significantly in the evolution of our relationships with our key customers, as we are able to serve multiple delivery locations and provide multiple delivery options with flexible lead times and costs, allowing us to better serve our customers with multiple price points based on different delivery models. We have a track record of nurturing customer relationships, commencing from a single geography or a particular product and gradually evolving over the years to a multi-geography or multi-product association with a long-term strategic alignment.

### Manufacturing, Warehousing and Distribution Facilities

The map below illustrates our manufacturing, warehousing and distribution facilities worldwide, as of December 31, 2021:



(Note: Map not to scale)

### Manufacturing Facilities

#### Ludhiana

We currently have two manufacturing facilities in Ludhiana, in the state of Punjab in India, covering an aggregate area of approximately 4.47 acres and an aggregate built-up area of approximately 216,603.00 sq. ft. We have recently expanded one of our Ludhiana, Punjab facilities, thereby enabling it to cater to our domestic business as well. In addition, we have leased additional area at Ludhiana, Punjab where we have extended our overall manufacturing operations.

Our ISO 9001:2015 certified Ludhiana, Punjab facilities are our source of machined forgings (hammer, upset and metal gathering), advanced die and tool building with PRO Engineer backend support for components/sub-assemblies and structural fabrications for OEM in India and our other India facilities, and is the first level of processing for a majority of our products for our other Indian facilities and also serve as a hub for our domestic sales. Our Ludhiana, Punjab facility also manufactures PTO products and precision machined parts called plungers for use in oil and gas industry. Some of our aftermarket customers are directly serviced from the Ludhiana, Punjab

facilities, and some of our PMP capabilities are also available in the Ludhiana, Punjab facilities.

At our Ludhiana, Punjab facilities, we have in-house heat treatment (continuous, induction, pit furnace and GCF furnaces), CNC and VMC machining, robotic welding and special purpose machinery, metal inert gas welding, pulsating welding and butt welding. We have spline rolling and hobbing capabilities. Advanced fabrication shop for light to heavy duty applications, painting, plating, powder coating, zinc and manganese phosphating and plastic dip coating.

Power for this facility is sourced from the local grid, with backup from our on-site diesel generators.

#### *Visakhapatnam*

We have a manufacturing facility in Visakhapatnam, in the state of Andhra Pradesh in India. Our Visakhapatnam, Andhra Pradesh facility was commissioned in Fiscal 2009 and is situated within an SEZ and dedicated to our export operations. The operations of the facility are managed on a fully integrated ERP system. This is an integrated facility and is our largest facility and is located across an aggregate area of approximately 30 acres and an aggregate built-up area of 300,008.04 sq. ft., including 85,577.14 sq. mts. of unutilized area available for scaling up of our operations. In addition to the unutilized area available for scaling up of our operations, certain manufacturing processes including heat treatment and plating, were built to accommodate any such expansion or capacity creation.

This ISO 14001:2015 and ISO 9001:2015 certified facility is equipped with bar code technology for production reporting and material handling and serves as a hub for our export OEM sales. Our Visakhapatnam, Andhra Pradesh facility manufactures 3PL, PMP and hydraulic cylinders, primarily for the agriculture and CFM sectors. At our Visakhapatnam, Andhra Pradesh facility, we have in-house capacity for cold drawing, CNC machining, laser cutting and welding (including butt and robotic welding), heat treatment (sealed quench furnace), induction hardening, shot blasting, grinding, painting, plating, metallurgical laboratory, hydraulic assembly clean room.

Power for this facility is sourced from the local grid, with backup from our on-site diesel generators.

#### *Noida*

We have two manufacturing facilities in Noida, in the state of Uttar Pradesh in India, established in two phases in Fiscal 2000 and Fiscal 2006. These facilities are set up across two plots, across an aggregate area of approximately 8.185 acres and an aggregate built-up area of approximately 197,559.00 sq. ft. One of our two facilities in Noida, Uttar Pradesh is located within an SEZ dedicated to our export operations and is operated by us through our Subsidiary, GFPL. These facilities primarily serve the 3PL and PMP segments, primarily for the agriculture and CFM sectors. Both the Noida, Uttar Pradesh facilities are also equipped with bar code technology for production reporting and material handling and are managed on a fully integrated ERP system.

Both these facilities are ISO 9001:2015 and ISO 14001:2015 certified. One of our Noida, Uttar Pradesh facilities serves as a hub for our aftermarket sales in the United States and Europe and the other serves as a hub for our domestic and export OEM sales.

At our Noida, Uttar Pradesh facilities, we have in-house capacity for conventional and CNC and VMC machining processes, welding (including butt and robotic welding), induction hardening, grinding, shot blasting, heat treatment (continuous and pit furnace), plating, painting, ED coating and assembly. We have added a complete cell at one of our facilities to produce pins for construction equipment weighing up to 100 kilograms. We have a metallurgical lab at one of our Noida, Uttar Pradesh facility and a complete test rig with capability of up to 400 kilonewton enabling testing for high horse power tractor segment.

Power for this facility is sourced from the local grid, with backup from our on-site diesel generators. The operations of the facility are managed on a fully integrated ERP system.

We also have a distribution facility in Noida, Uttar Pradesh established in Fiscal 2018 across an area of approximately 1.24 acres. In addition, we established a unit for raw material storage in Noida, Uttar Pradesh in Fiscal 2018, which is spread across approximately 0.96 acres. The aggregate built-up area across these two facilities is 73,700 sq. ft. We also have a storage unit in Noida, Uttar Pradesh.

#### *Eldridge, Iowa, United States*



We have a manufacturing, warehousing and distribution facility in Eldridge, Iowa, United States acquired pursuant to our acquisition in 2005 of UOI. This facility has been set up across an aggregate area of approximately 9.52 acres and a built-up area of approximately 136,481.00 sq. ft. In addition, we leased additional area of approximately 15,000.00 sq. ft. of built-up area which is being utilized for warehousing purposes.

This ISO 9001:2015 certified facility serves as a hub for our sales of PMP products for the agriculture, construction, and material handling sectors for OEMs in the United States, and has an in-house induction hardening capability in addition to machining (precision turning, drilling, milling, grinding, and welding) and other related finishing processes. This facility primarily serves the North American market, with local production as well as warehousing and distribution of products manufactured in and exported from India.

Our manufacturing core competencies at this facility include induction hardening, various CNC operation on turn mill centers as well as machining centers, grinders with inline allowing us to produce products in a wide range of sizes and fatigue loads, for various applications and duty cycles. PMP products such as precision pins, bushings and bosses represent a majority of our product mix at this facility. Other smaller segments of the product mix include miscellaneous precision CNC machined parts.

### ***Warehousing and Distribution Facilities***

#### *Augusta, Georgia, United States*

We currently have one large leased location that serves as a complete warehouse, which is 8.00 acres. This warehousing facility is completely managed by our own resources and systems and processes. This facility is completely integrated through our ERP systems and is also equipped with bar coding infrastructure for efficiency optimization.

This facility serves as our base for serving our North and South American customers, as well as aftermarket retail stores.

#### *Hennef, Germany*

We have a 2,063.68 sq. mt. warehousing and distribution facility in Europe, in Hennef, Germany, which has been which has been taken on lease since Fiscal 2010. This facility is completely integrated through our ERP systems and is also equipped with bar coding infrastructure for efficiency optimization.

This facility serves as our base for serving our key European customers.

### **Installed Capacity and Capacity Utilization**

Set forth below are details of the product-wise installed capacity of our manufacturing facilities as of March 31, 2019, March 31, 2020, March 31, 2021, and as of December 31, 2021, and production volumes and capacity utilization for the Fiscal 2019, 2020 and 2021, and in the nine months ended December 31, 2021.

Manufacturing facility	Installed capacity as of March 31, 2019	Fiscal 2019		Installed capacity as of March 31, 2020	Fiscal 2020		Installed capacity as of March 31, 2021	Fiscal 2021		Installed capacity as of December 31, 2021	Nine months ended December 31, 2021	
		Production (in tonnes)	Capacity utilization (%)		Production	Capacity utilization (%)		Production	Capacity utilization (%)		Production	Capacity utilization (%)
B-208, Noida, Uttar Pradesh India	16,500	13,219	80.12	16,500	8,944	54.21	15,000	9,551	63.68	15,000	9,854	87.59
GFPL, Noida, Uttar Pradesh, India	6,000	5,477	91.28	6,600	4,629	70.13	7,200	5,045	70.07	8,400	5,301	84.14
Vishakhapatnam, Andhra Pradesh, India	13,440	10,494	78.08	13,440	8,380	62.35	13,440	7,911	58.86	13,440	8,314	82.48
Farmparts, Ludhiana, Punjab, India	9,000	8,512	94.58	9,000	6,250	69.44	9,500	7,698	81.03	10,000	7,703	102.71
SKG, Ludhiana, Punjab, India	12,000	8,424	70.20	12,000	8,137	67.81	13,500	9,602	71.13	15,000	9,216	81.92
Eldridge, Iowa,	7,200	5,171	71.82	7,200	3,959	54.99	5,100	2,397	47.00	5,100	1,885	49.28

Manufacturing facility	Installed capacity as of March 31, 2019	Fiscal 2019		Installed capacity as of March 31, 2020	Fiscal 2020		Installed capacity as of March 31, 2021	Fiscal 2021		Installed capacity as of December 31, 2021	Nine months ended December 31, 2021	
		Production (in tonnes)	Capacity utilization (%)		Production	Capacity utilization (%)		Production	Capacity utilization (%)		Production	Capacity utilization (%)

USA., UOI

Notes:

- (1) Since our Company is in discrete manufacturing, the total capacity of the manufacturing unit is worked out on the basis of the total output of each intermediate process. Hence, in the event that there are any bottlenecks in an intermediate process and a part of the process gets outsourced, then the overall capacity can exceed 100.00%.
- (2) The key general purpose machines were influencing the production capacity and these can be interchangeable across product categories.
- (3) Capacity utilization has been calculated basis the actual production in the relevant Fiscal/ period divided by the available capacity available for the relevant Fiscal/ period.
- (4) The information relating to the aggregate production capacity of our manufacturing facilities as of the periods included above and elsewhere in this Draft Red Herring Prospectus are based on various assumptions and estimates of our management that have been taken into account by the chartered engineer in the calculation of our capacity. These assumptions and estimates include the standard capacity calculation practice of the manufacturing industry after examining the manufacturing capacity installed at the plant, the calculations and explanations provided by our management, the period during which the manufacturing facilities operate in a year, availability of raw ingredients, expected utilization levels, downtime resulting from scheduled maintenance activities, unscheduled breakdowns, as well as expected operational efficiencies. Actual production levels and utilization rates may differ significantly from the estimated production capacities or historical estimated capacity utilization information of our facilities. Undue reliance should therefore not be placed on our production capacity or historical estimated capacity utilization information for our existing facilities included in this Draft Red Herring Prospectus. See “**Risk Factors – Information relating to our production capacities and the historical capacity utilization of our manufacturing facilities included in this Draft Red Herring Prospectus is based on various assumptions and estimates and future production and capacity utilization may vary.**” on page 50.

## Raw Materials

Steel is the main raw material required for our manufacturing operations. We have a diverse portfolio of vendors supplying steel and we are not significantly dependent on any single vendor. Steel accounted for 62.02%, 62.69%, 59.18% and 59.96% of our raw material purchases in value terms in Fiscal 2019, 2020 and 2021, and in the nine months ended December 31, 2021 respectively. Steel sourced in India accounted for 45.78%, 45.88%, 51.44% and 53.21% and our expenditure on steel sourced in United States accounted for 16.25%, 16.82%, 7.74% and 6.75% of our raw material purchases in value terms in Fiscal 2019, 2020 and 2021, and in the nine months ended December 31, 2021, respectively.

**3PL:** The raw material used by us for the 3PL vertical primarily includes steel bars, which we convert to forgings or use as blanks for machining, steel flats, steel tubes and castings.

**PMP:** The raw material used by us in the PMP vertical primarily includes steel bars in solid or tubular geometry, or steel plates. Forgings are also used as input material for some PMP variants. We use various grades of steel and is procured by us primarily in various forms in the United States and India. At our Visakhapatnam, Andhra Pradesh facility, we perform cold drawing as an in-house operation and for our in-house consumption.

**Hydraulic cylinders:** The raw material used by us for the hydraulic cylinders vertical primarily includes hydraulic cylinder tubes, procured in honed or roller burnished condition, hard chrome bar and forgings, as well as castings for components like piston, glands, joints and hydraulic seals.

**PTO Applications:** The raw material used by us in PTO applications primarily includes steel bars, forgings and castings. The PTO requires plastic shielding to prevent accidents.

**Fabrication:** The raw material used by us in Fabrication applications primarily includes steel forgings and castings.

For our Indian manufacturing operations, we source steel directly from Indian steel mills. We have also developed a supply chain for sourcing specific forms of steel from China, for our manufacturing facilities in India. Steel used for products manufactured in our Eldridge facility is sourced within the United States from distributors.

## Inventory Management

Our finished products are stored on-site at our manufacturing facilities. The raw materials are also stored at our warehouses on-site. We typically keep up to three to four months of inventory including raw materials, work in progress and finished good at our facilities to mitigate the risk of raw material price movements. These inventory

levels are planned based on historical trends and expected orders, which are confirmed due to our long-standing relationships with customers. We maintain a lead-time material requirement planning system and utilize our ERP system to manage our levels of inventory on a real-time basis.

### **Value Engineering and Process Innovation**

We differentiate ourselves from other component suppliers through our in-house value engineering and process innovation capabilities, supported by product development programs undertaken jointly with some of our key customers, translating into our diversified presence across sectors, markets and product verticals. Over the years, we believe that we have become an integral part of the global and local supply chains of some of our key customers. In particular, we have benefited from our strategic acquisition of UOI in 2005, which catalyzed the growth of our PMP product vertical and our growth in the CFM sector. We continue to collaborate with our key customers on joint product development and process innovation programs, to upgrade and customize our products in tandem with customer specifications and requirements.

As part of our transition from a component manufacturer to solutions provider and further as a system integrator, we have, over the years added several products to our portfolio such as rear hitch, front hitch, hydraulic lift arms, power take off, trailer hitch and more which allow us to offer integrated system solutions to meet our customer requirements and move up the value chain. As part of expanding our product portfolio with solutions for adjacent vehicle and equipment types such as utility task vehicles and all-terrain vehicles, we have developed prototypes of system solutions which are currently in the trial phase. Also, we have extended the PMP portfolio to more products with a technology focus such as plungers and transmission components.

Our Non-Executive Director, Herbert Coenen, is in charge of business development and technology advancement, and is supported by several highly skilled and experienced personnel. As of December 31, 2021, we had 180 full-time employees having engineering degrees, while 169 others are technical diploma holders, and 88 have other professional qualifications.

### **Business Development and Sales**

We have a global footprint, serving OEMs and the aftermarket across six continents, including emerging markets such as South America and India. Our largest geography in terms of sales has been the Americas, which accounted for 56.20%, 57.21%, 48.16% and 46.33%, respectively, of our revenue from operations during Fiscal 2019, 2020 and 2021, and in the nine months ended December 31, 2021. During the same periods, our sales in Europe accounted for 18.07%, 18.19%, 23.32% and 25.33%, respectively; Asia-Pacific accounted for 2.07%, 1.84%, 1.87% and 2.05%, respectively; India accounted for 12.63%, 12.63%, 15.87% and 14.42%, respectively, and Japan accounted for 4.57%, 4.64%, 4.52% and 4.64%, respectively, of our revenue from operations. Sales of 3PL contributed to 47.45%, 47.17%, 56.10% and 55.68%, respectively, of our revenue from operations and PMP contributed to 46.83%, 47.65%, 37.62% and 36.35%, respectively, of our revenue from operations in the same periods. During the same periods, our sales to the agriculture sector comprised 60.59%, 59.98%, 69.80% and 70.66%, respectively, and sales to the CFM sector comprised 35.00%, 35.76%, 26.27% and 24.76% of our revenue from operations, respectively.

OEM sales accounted for 82.21%, 81.12%, 77.31% and 77.31%, respectively, of our revenue from operations in Fiscal 2019, 2020 and 2021, and in the nine months ended December 31, 2021. Our key customers, many of whom we enjoy long term relationships with, include TAFE, Bobcat and Yanmar.

We supply products to our customers on the basis of purchase orders, depending on the customer's preference and established practice. Our supply arrangements with our key OEM customers typically provide for periodic price review of our products (generally bi-annual, or quarterly in certain cases). This would typically include price resets on the basis of changes in raw material price, freight, inflation and foreign exchange rates. Additionally, we may be required to provide an annual cost reduction in relation to our products to some of our OEM customers. Our key customers also typically have centralized strategic sourcing teams, supported by various regional sourcing and procurement teams. Therefore, we believe that our dual-shore multiple delivery models (including premium-priced Local Deliveries manufactured onshore in smaller lots and with shorter lead times, as well as cost-competitive offshore deliveries from India with longer lead times and greater inventory cycles), together with our customized packing, shipping, delivery and other logistics solutions are a key component of our sales and marketing initiatives and also effectively function as an entry barrier for other suppliers that do not have the benefit of a global business model of the kind that we have built and developed over the years.

Aftermarket sales accounted for 13.68%, 15.06%, 18.89% and 18.57%, respectively, of our revenue from operations in Fiscal 2019, 2020, 2021 and in the nine months ended December 31, 2021. We service several leading players in the aftermarket segment in Europe and United States, such as Kramp and TSC.

Our business development team is centralized and is led by our Non-Executive Director, Herbert Coenen. Our business development team focuses on identifying and developing customer relationships and securing new contracts. Our business development team comprised 26 employees, as of December 31, 2021.

The sales and customer service function is decentralized at each physical location that ships out products to our customers. With strong customer orientation and commitment, we endeavour to constantly meet high standards of delivery and response time as per the expectations of our customers. Our global sales teams comprised 29 employees, as of December 31, 2021.

As we expand into newer geographies, we would continuously evaluate the requirement of additional warehousing facilities and deployment of team or marketing representatives to ensure our presence in the same geography as the end customer, so as to strengthen our customer relationships.

### **Customers**

As of December 31, 2021, we have a large customer base of over 125 customers, diversified across industries and geographies. We have deeply entrenched and long-established relationships with most of our customers. A number of our customers have been associated with us for over 10 years.

Our customer base is well diversified. While our top 10 customers contributed 75.64%, 74.62%, 73.08% and 70.73%, respectively, of our revenue from operations in Fiscal 2019, 2020 and 2021 and in the nine months ended December 31, 2021, the contribution of top 15 customers was 82.10%, 81.73%, 80.43% and 78.11%, respectively, of our revenue from operations in such periods. Our single largest customer contributed 39.65%, 36.87%, 34.15% and 32.68%, respectively, of our revenue from operations in Fiscal 2019, 2020 and 2021 and in the nine months ended December 31, 2021.

### **Warranty Arrangements**

The warranty arrangements or conditions for our products are covered under the general purchase terms and conditions of our customers. To the extent that such OEM customers provide a warranty to their end users and incur warranty costs for non-conformity of their products to agreed specifications or standards, our supply arrangements with our OEM customers typically allow us to review warranty claims in order to determine if the failure was caused by a manufacturing defect in our products. If it is determined that the failure was on account of a manufacturing defect in our products, we are typically required to promptly correct or replace those defective products at our own expense and prepare a written corrective action plan, failing which, we may be required to reimburse our OEM customers at part acquisition cost, with additives to cover administrative, labour, material and other such costs. The standard warranty period for our products is 12 to 24 months but, in the case of certain specified types of equipment in which our components are used, may extend to 36 months or longer.

With certain OEM customers, we may also be required to follow performance improvement programs, whereby, if a particular product or batch of products is not found conforming to the specified quality standards, the product is replaced, followed by a correction program.

Where we have not entered into warranty agreements with certain of our customers, our customers can raise debit notes equal to or more than the selling price of the products that are rejected and physically returned to us or scrapped at the customer's end after our approval. While we maintain insurance coverage, including a product liability insurance, in keeping with what we believe to be the industry standard, we may not be sufficiently insured against punitive damage awards. For further information, see, "**Risk Factors – An adverse determination in a significant product liability or performance improvement claim or significant replacement costs may adversely affect our business, financial condition, results of operations and prospects.**" on page 43.

### **Quality Control, Environment and Occupational Health and Safety**

Each of our facilities in India as well as our Eldridge facility are ISO 9001:2015 certified. This standard specifies requirements for a quality management system. Both of our manufacturing facilities in Noida, Uttar Pradesh and our facility in Visakhapatnam, Andhra Pradesh are also ISO 14001:2015 certified. This standard specifies

requirements for an environmental management system.

We are committed to following applicable environmental and occupational health and safety laws as well as industry best practices. In accordance with the terms of our supply arrangements with our key customers, we are also committed to maintaining acceptable safety and quality systems, specifications and standards set by those customers, including the requirement for on-time delivery and for on-site and off-site inspections of our products and facilities by our customers.

For information regarding applicable health, safety and environmental laws and regulations, see “**Key Regulations and Policies in India**” and “**Government and Other Approvals**” on pages 176 and 393, respectively.

### **IT and Management Tools**

For bringing synergies between our facilities engaged in forward as well as backward integrated supply chain, we have invested in ERP systems, implemented across our operations in the United States, Germany and our facilities in India. We have also implemented business intelligence tools in order to enable key metrics and performance dashboards available at a click of a button. In addition, the business critical IT Infrastructure is hosted at a renowned tier-3 data centre with 24x7 monitoring and service support. We have three-tier secure access and network connectivity across locations, as well as business continuity plans, and a facility and asset management system, all of which facilitates integration intra-group as well as with customer systems. Our IT systems are managed by an in-house IT team. We believe that the resulting automation and transparency has strengthened the scalability of our operations worldwide and will help us in achieving synergies from strategic acquisitions and investments that we may undertake in the future.

We explore and adopt efficiency enhancement and automation tools. We undertake and foster data analytics and data-based decision making. We have also digitalized our key processes such as customer relationship management, quality management and order book management which helps in anytime groupwide information dashboards and effective management and decision making. We have implemented strategy deployment framework across all our operating locations thereby ensuring that process and employee level goals are completely aligned to the short and long term organizational strategy and objective.

### **Awards and Recognitions**

We have received several prestigious awards and certifications from our customers, including ‘Best Supplier Award’ from TAFE in 2014 and ‘Kubota India GM Award - 2014’ from Kubota. Our Subsidiary, UOI has been inducted in the 15 years hall of fame (1991-2005) by John Deere and it has also been inducted in the 10 years hall of fame (1991-2000) by John Deere Davenport Works.

We have also been awarded the ‘Most Versatile Supplier 2020’ from Kubota India and “Overall Excellence in Procurement and Sourcing Cost Reduction” in the Procurement Tech Summit and Awards 2019. We won a silver trophy in the CII National Kaizen Circle Competition 2019 and two silver awards under the category of “Low Cost Automation in Tapping Process” in the 11th National Kaizen Competition 2020.

Further, we have also received a recognition from JCB at the JCB Annual Supplier Conference in 2010. In 2013, our facility at Visakhapatnam, Andhra Pradesh was awarded the first prize at the CII Kaizen Competition, and in 2016, our Company was awarded at the 7<sup>th</sup> National Kaizen Competition with Special Kaizen Award by the Chamber of Industrial and Commercial Undertaking. In addition, we also received the ‘Company with Great Managers’ trophy from The Times of India Group in 2016. We have also received the Star Performer award under Large Enterprise Category for Product Group - Automobile Components for 2017 – 2018 from EEPC India (formerly, the Engineering Export Promotion Council, set up under the sponsorship of the Ministry of Commerce and Industry, India).

Our Company received the ‘Best Supplier Award’ in 2018 for outstanding contribution in co-creating value by TAFE. In 2018, we were also awarded a special trophy for excellence in exports of MEIS items by EEPC. At the 2018 CICU Kaizen competition, we were awarded the second prize in the Poka-Yoke to complete electrical circuit for welding process and a special prize for quality improvement. Our Company has also been recognized as a three-star export house by the Ministry of Commerce and Industry, Government of India until 2020, as per the Indian Foreign Trade Policy 2015 – 2020.

### **Competition**

While there are several producers of varying size serving certain segments or sub-segments of our customer base, across agriculture and CFM, and there are also several producers of varying size manufacturing certain of the products that we sell, in various geographical markets, we believe that we have no peers that operate in the full spectrum of our customer base, geographical market, product range and price points. We also believe that our ability to offer end-to-end solutions to our customers (such as entire 3PL assemblies), instead of individual components, and our emphasis on the global business model to meet our customers' varying requirements, differentiate us from our competition and also effectively function as an entry barrier for suppliers that do not have the benefit of a global business model of the kind that we have built and developed over the years.

As per the CRISIL Report, certain key players for PMP include General Grind & Machine (headquartered in Illinois, United States), Società Italiana Boccole Srl (headquartered in Bologna, Italy), Vishal Engineers (headquartered in Haryana, India), while those for 3PL include CBM Group (headquartered in Modena, Italy), GNK Walterscheid plc (headquartered in Lohmar, Nordrhein-Westfalen, Germany), Maxiforja Componentes Automotivos (headquartered in Canoas, Brazil), Sudtrac Linkages (headquartered in Haryana, India), Delica Co., Ltd. (headquartered in Matsumoto, Japan) (*Source: CRISIL Report*).

As the parameters of competition in this business are less firmly established than in certain other types of businesses and there are no standard methodologies to assess this industry as far as we are aware, we believe that it is difficult to predict how the competitive landscape of our business will develop over the long term. General competitive factors in the market, which may affect the level of competition over the short and medium term, include vulnerability to overall macroeconomic factors, time to market, availability of after-sale and logistics support, product features, design, quality, price, delivery, warranty, general customer experience and relationships between producers and their customers.

## Employees

As of December 31, 2021, we had 2,143 employees, of which 665 employees were in the regular staff category and 1,478 employees were in the regular labour category. Set out below are details of our regular staff employees, as split by location and professional qualifications.

<b>Total number of regular staff employees</b>	665
<b>By Location</b>	
India	630
Overseas	35
<b>By Professional Qualification</b>	
Engineering degrees	180
Technical diploma holders	169
Other professional qualifications	88
Others	228

Additionally, as December 31, 2021, we also utilized the services of 2,017 persons engaged as contract labour and 290 engaged as apprentice.

We currently do not have any registered trade unions at any of our facilities.

We are dedicated to the development of the expertise and know-how of our employees. Our personnel policies are aimed towards recruiting talented individuals, facilitating their integration, and promoting the development of their skills, including through in-house and on-site as well as external training programmes. In addition to compensation that includes salary and allowances, our employees receive statutory benefits (including employees' provident fund, employees' state insurance, pension, retirement and gratuity benefits, workman's compensation, maternity and other benefits, as applicable) and are covered by group accident and health insurance.

## Corporate Social Responsibility

We have constituted a Corporate and Social Responsibility Committee of our Board and have adopted and implemented a CSR policy, pursuant to which we carry out various CSR activities. Our CSR activities include, among others contribution towards Sharda Foundation for promotion of healthcare activities and medical aid. The Sharda Foundation has also made contributions to the Dashmesh Charitable Hospital Society for promoting healthcare.

## Insurance

We maintain insurance policies with independent insurers in respect of our buildings, plant and machineries, fixtures and fittings, vehicles, other equipment and inventories. The coverage under such insurance policies is in respect of losses due to fire (including standard fire and allied perils) and burglary, for amounts that we believe are in keeping with industry standard. We also have availed of fidelity guarantee and money insurance policies.

We cover our employees under group accident and medical insurance programs, except in respect of locations where our workforce is covered under the ESI scheme. As part of our response to the COVID-19 pandemic, we have obtained a group term life insurance for our employees.

Under our supply arrangements with our key OEM customers, the risk of loss to the raw materials procured by us as well as to the products supplied by us typically remains with us until the title, risk and rewards and control on our products passes from us to such customers. Therefore, we maintain marine cargo insurance for our exports, imports and domestic sales and purchases. Further, as our supply arrangements with certain of our key OEM customers require us to maintain product liability insurance, we maintain comprehensive general liability insurance which includes product liability, product recall, product guarantee and financial loss coverage with independent insurers. We also maintain public liability insurance against the statutory liability arising out of accidents due to handling hazardous substances.

We do not presently maintain insurance for business interruption at India. We maintain insurance for directors and officer's liability across all our locations.

For further information, see "**Risk Factors – Our insurance coverage may not adequately protect us from all material risks and liabilities.**" on page 51.

## Intellectual Property

We have six registered trademarks under class 12, of which we use "U", "G" and "U", as a stamp on our products and "U" as our corporate logo. All our trademarks are registered in the name of our Company, except for the wordmark "GRIPWEL" under class 6, 7 and 12 in Canada and class 7 and 12 in the European Union, which is registered under the name of one our Subsidiary, GFPL.

We have applied for an Indian patent as well as an international patent, with respect to a component that we have developed, the lower link hook. We also protect designs and drawings for our products through non-disclosure agreements that we enter into with our customers.

For further information, see "**Risk Factors – We may not be able to adequately protect our intellectual property rights, including the use of the "Uniparts" name and associated logo, which could harm our competitiveness.**" on page 56.

## Properties

The brief details of our owned and leased immovable properties are set out below:

S. No.	Location	Use	Approximate Plot Size (in acres unless mentioned otherwise)	Nature of Right/ Title	Lease Period	Address
1.	Farmparts, Ludhiana, Punjab, India		2.25	Owned / Leased	/ Of the 1.18 acres, 0.59 acres has been leased with effect from August 10, 1997 to August 9, 2096. The remaining portion of the plot is a freehold property of our Company.	D-126-A, 127-A Phase-V, Focal Point, Ludhiana – 141 010, Punjab
2.	Farmparts, Ludhiana, Punjab, India	Manufacturing facility		Owned - Leasehold	- The plot comprising of 1.06 acres has been leased with effect from January 19, 1993 to January 18, 2092.	Plot No. C-140, Phase-V, Focal Point, Ludhiana – 141 010, Punjab
3.	SKG, Ludhiana,		2.22	Owned - Leasehold	- The 2.22 acre consists of 2 plots, 0.97 acre leased with	C-197, 198, Phase-VII, Focal Point,

S. No.	Location	Use	Approximate Plot Size (in acres unless mentioned otherwise)	Nature of Right/ Title	Lease Period	Address
	Punjab, India				effect from March 5, 1998 to March 4, 2097 and 1.25 acres has been leased with effect from July 21, 1988 to July 20, 2087.	Dhandari Kalan, Ludhiana – 141 010, Punjab
4.	Ludhiana, Punjab, India		0.92	Leased	The lease is valid with effect from February 1, 2018 to January 31, 2023.	Plot No.-E-754, Focal Point, Phase-VIII, Ludhiana – 141 010, Punjab
5.	Visakhapatnam, Andhra Pradesh, India	Manufacturing facility	30.01 (SEZ land)	Leased	The lease is valid with effect from November 1, 2007 to October 31, 2042.	Plot No. 47, APIIC, APSEZ, Pudimadaka Road, Opposite: 11 KV Substation, Atchutapuram, Rambilli Mandalam, Visakhapatnam, Andhra Pradesh
6.	B-208, Noida, Uttar Pradesh, India	Manufacturing facility	5.07	Owned – Leasehold	The lease is valid with effect from November 9, 1998 to November 8, 2088.	B-208/A1 & A2, Phase II, Noida – 210 301, Uttar Pradesh
7.	GFPL, Noida, Uttar Pradesh, India		3.10 (SEZ land)	Leased	The lease is valid for a period of 15 years with effect from February 22, 2012	142A/30-142A/51, NSEZ, Noida – 201 305, Uttar Pradesh
8.	Noida, Uttar Pradesh	Raw material storage space	0.96	Leased	The lease is valid with effect from October 25, 2017 to October 24, 2022.	B-33 and B-34, Phase-II, Sector-81, Noida – 201 304, Uttar Pradesh
9.	Noida, Uttar Pradesh	Distribution centre	1.24	Leased	The lease is valid with effect from January 1, 2018 to December 31, 2025.	A-8, Sector-84, Noida – 201 304, Uttar Pradesh
10.	Eldridge, Iowa, United States, UOI	Manufacturing facility	9.52	Leased	The lease is valid with effect from March 28, 2002 to January 31, 2030 .	1100, East Le Claire Road, Elridge, Iowa 52748, United States
11.	Richmond County, Georgia, UUL	Warehousing facility	8.00	Leased	The lease is valid with effect from July 1, 2018 to June 30, 2023	1431 Marvin Griffin Rd, Richmond County, Georgia, United States
12.	Hennef, Germany	Warehousing facility	2,063.68 sq. mts. of built up area	Leased	The lease is valid with effect from January 1, 2017 to December 31, 2018 automatically extendable for further one year and is currently valid till December 31, 2022.	Reutherstraße 3, 53773 Hennef, Germany
13.	New Delhi, India	Office space (i.e., for our Registered Office)	400 sq. ft. of built up area	Leased	The lease is valid with effect from November 1, 2013 to October 31, 2022.	Gripwel House, Block-5, C-6 & 7 Vasant Kunj, New Delhi – 110 070
14.	Iowa, United States, UOI	Warehousing facility	15,000 sq. ft. of built up area	Leased	The lease is valid with effect from April 1, 2022 to March 31, 2023.	112, Third Avenue East, De Witt, Iowa, United States
15.	Noida, Uttar Pradesh, India	Storage facility	-	Leased	The lease is valid with effect from April 1, 2022 to February 28, 2023.	Flat 17B, Green View Apartment, Pocket 6, Sector 82, Noida – 201 304, Uttar Pradesh, India.
16.	Noida, Uttar Pradesh,	Guest house	-	Leased	The lease is valid with effect from February 1, 2022 to	Flat No. Aster 5/802, 7th Floor, Aster 5,



S. No.	Location	Use	Approximate Plot Size (in acres unless mentioned otherwise)	Nature of Right/ Title	Lease Period	Address
	India				December 31, 2022.	Supertech Emerald court, Plot No. 4 Sector-93A, Noida, Uttar Pradesh, India

Other than the SEZ land in Visakhapatnam, Andhra Pradesh and Noida, Uttar Pradesh, as disclosed above, which is leased by us from the respective SEZ authorities, the premises in which our other facilities and offices are located are leased by us from persons including government entities and members of our Promoter Group.

For further information, see “*Risk Factors – Certain of our immovable properties in India and overseas, and machinery are leased by us. If we are unable to renew existing leases or relocate our operations on commercially reasonable terms, there may be an adverse effect on our business, financial condition and operations.*” on page 53.

## KEY REGULATIONS AND POLICIES IN INDIA

*The following description is a summary of the relevant sector specific regulations and policies applicable in India, as prescribed by the Government or state governments which are, basis the jurisdiction in which our projects are located, applicable to our Company and our Indian Subsidiaries. The information detailed in this chapter has been obtained from publications available in the public domain and is based on the current provisions of Indian law and the judicial, regulatory and administrative interpretations thereof, which are subject to change or modification by subsequent legislative actions, regulatory, administrative, quasi-judicial, or judicial decisions. The description of the applicable laws and regulations set out below may not be exhaustive, and are only intended to provide general information to the investors and are neither designed nor intended to substitute for professional legal advice.*

*Under the provisions of various Central Government and State Government statutes and legislations, our Company and our Material Subsidiaries are required to obtain and regularly renew certain licenses or registrations and to seek statutory permissions to conduct our business and operations. For details, see “Government and Other Approvals” beginning on page 393.*

### **Environmental Laws**

We are subject to various environment regulations as the operation of our establishments might have an impact on the environment in which they are situated. The basic purpose of the statutes listed below is to control, abate and prevent pollution. In order to achieve these objectives, pollution control boards (“PCBs”), which are vested with diverse powers to deal with water and air pollution, have been set up in each state. The PCBs are responsible for setting the standards for maintenance of clean air and water, directing the installation of pollution control devices in industries and undertaking inspections to ensure that industries are functioning in compliance with the standards prescribed. These authorities also have the power of search, seizure and investigation. All industries are required to obtain consent orders from the PCBs, which are indicative of the fact that the industry in question is functioning in compliance with the pollution control norms. These consent orders are required to be periodically renewed.

#### ***The Environment (Protection) Act, 1986 (“EPA”) and the Environment (Protection) Rules, 1986***

The EPA is an umbrella legislation designed to provide a framework for the Government to protect and improve the environment. The EPA vests with the Government, the power to take any measure it deems necessary or expedient for protecting and improving the quality of the environment, and preventing and controlling environmental pollution. This includes rules for the quality of environment, standards for emission of discharge of environment pollutants from various sources as provided under the Environment (Protection) Rules, 1986, inspection of any premises, plant, equipment, machinery, and examination of manufacturing processes and materials likely to cause pollution.

#### ***The Water (Prevention and Control of Pollution) Act, 1974 (“Water Act”)***

The Water Act aims to prevent and control water pollution by factories and manufacturing units and maintain and restore the quality and wholesomeness of water. Under the Water Act, any person establishing any industry, operation or process, any treatment or disposal system, use of any new or altered outlet for the discharge of sewage or new discharge of sewage, must obtain the consent of the relevant state PCB, which is empowered to establish standards and conditions that are required to be complied with.

#### ***The Air (Prevention and Control of Pollution) Act, 1981 (“Air Act”)***

The Air Act provides for the prevention, control and abatement of air pollution. Pursuant to the provisions of the Air Act, any person establishing or operating any industrial plant within an air pollution control area, must obtain the consent of the relevant state PCB prior to establishing or operating such industrial plant. The state PCB must decide on the application within a period of four months of receipt of such application. No person operating any industrial plant in any air pollution control area shall discharge or permit or cause to be discharged the emission of any air pollutant in excess of the standards laid down by the state PCB.

#### ***The Hazardous and Other Wastes (Management and Transboundary Movement) Rules, 2016 (“Hazardous Wastes Rules”)***

The Hazardous Wastes Rules aim to regulate the proper collection, reception, treatment, storage and disposal of hazardous waste. The Hazardous Wastes Rules impose an obligation on every occupier and operator of a facility

generating hazardous waste to dispose of such waste without causing adverse effect on the environment, including through the proper collection, treatment, storage and disposal of such waste. Every occupier and operator of a facility generating hazardous waste must obtain an approval from the relevant PCB. The occupier, the transporter, the operator and the importer are liable for damages caused to the environment resulting from improper handling and disposal of hazardous waste. The operator and the occupier of a facility are liable for any fine that may be levied by the relevant state PCB.

### ***The Public Liability Insurance Act, 1991 (“PLI Act”)***

The PLI Act imposes liability on the owner or controller of hazardous substances for any damage arising out of an accident involving such hazardous substances. The Government by way of a notification has enumerated a list of hazardous substances. The owner or handler is also required to obtain an insurance policy insuring against liability to provide relief under the terms of the legislation. The rules made under the PLI Act mandate that the employer has to contribute towards the Environmental Relief Fund a sum equal to the premium paid on the insurance policies. The amount is payable to the insurer.

### **Labour Related Regulations**

The employment of workers, depending on the nature of activity, is regulated by a wide variety of generally applicable labour laws. The following is an indicative list of labour laws which may be applicable to our Company and our Indian Subsidiaries due to the nature of the business activities:

1. Contract Labour (Regulation and Abolition) Act, 1970;
2. Employees’ Provident Funds and Miscellaneous Provisions Act, 1952;
3. The Factories Act, 1948;
4. The Employees State Insurance Act, 1948;
5. Minimum Wages Act, 1948;
6. Payment of Bonus Act, 1965;
7. Payment of Gratuity Act, 1972;
8. Payment of Wages Act, 1936;
9. Maternity Benefit Act, 1961;
10. Industrial Disputes Act, 1947;
11. Employees' Compensation Act, 1923;
12. Inter-State Migrant Workmen (Regulation of Employment and Conditions of Service) Act, 1979; and
13. Various shops and establishments legislations, as applicable, in the states in which our establishments are set up.

**In addition to the aforementioned, the following labour codes have received the assent of the President of India, and will come into force as and when notified in the Gazette, pursuant to which the abovementioned labour laws will be subsumed by the following:**

### ***The Code on Wages, 2019 (the “Wage Code”)***

The Code on Wages, 2019 received the assent of the President of India on August 8, 2019 and proposes to subsume four existing laws namely, the Payment of Wages Act, 1936, the Minimum Wages Act, 1948, the Payment of Bonus Act, 1965 and the Equal Remuneration Act, 1976. The Ministry of Labour and Employment vide notification dated December 18, 2020 notified certain provisions of the Wage Code. The provisions of this code will be brought into force on a date to be notified by the Central Government.

### ***The Occupational Safety, Health and Working Conditions Code, 2020***

The Occupational Safety, Health and Working Conditions Code, 2020 received the assent of the President of India on September 28, 2020 and proposes to subsume certain existing legislations, including the Factories Act, 1948, the Contract Labour (Regulation and Abolition) Act, 1970, the Inter-State Migrant Workmen (Regulation of Employment and Conditions of Service) Act, 1979 and the Building and Other Construction Workers (Regulation of Employment and Conditions of Service) Act, 1996. The code proposes to provide for *inter alia* standards for health, safety and working conditions for employees of the establishments. The provisions of this code will be brought into force on a date to be notified by the Central Government.

### ***The Industrial Relations Code, 2020***

The Industrial Relations Code, 2020 received the assent of the President of India on September 28, 2020 and it proposes to subsume three existing legislations, namely, the Industrial Disputes Act, 1947, the Trade Unions Act, 1926 and the Industrial Employment (Standing Orders) Act, 1946. The provisions of this code will be brought into force on a date to be notified by the Central Government.

### ***The Code on Social Security, 2020 (“Social Security Code”)***

The Social Security Code received the assent of the President of India on September 28, 2020 and it proposes to subsume certain existing legislations including the Employee's Compensation Act, 1923, the Employees' State Insurance Act, 1948, the Employees' Provident Funds and Miscellaneous Provisions Act, 1952, the Maternity Benefit Act, 1961, the Payment of Gratuity Act, 1972, the Building and Other Construction Workers' Welfare Cess Act, 1996 and the Unorganised Workers' Social Security Act, 2008. The new code proposes to set up a National Social Security Board and State Unorganized Workers Board to administer schemes for unorganized workers. The Social Security Code aims to provide uniformity in providing social security benefits to the employees which was earlier segregated under different acts and had different applicability and coverage. The Social Security Code has introduced the concept of workers outside traditional employee-employee work-arrangements (including in online and digital platforms such as ours), such as 'gig workers' and 'platform workers' and provides for the mandatory registration of such workers in order to enable these workers to avail benefits of, among others, life and disability cover, health and maternity benefits, old age protection, under schemes framed under the Social Security Code from time to time. Further, the Social Security Code provides that such schemes may *inter alia*, be partly funded by contributions from platforms such as ours. The provisions of this code will be brought into force on a date to be notified by the Central Government.

### **Other Labour law legislations:**

In addition to the aforementioned material legislations which are applicable to our Company, some of the other labour legislations that may be applicable to the operations of our Company include:

1. State-wise Labour welfare fund legislations and rules made thereunder;
2. The Employment Exchanges (Compulsory Notification of Vacancies) Act, 1959 and the rules made thereunder;
3. Rights of Persons with Disabilities Act, 2016; and
4. Child and Adolescent Labour (Prohibition and Regulation) Act, 1986.

### **Laws relating to Intellectual Property**

In India, patents, trademarks and copyrights enjoy protection under both statutory and common law. The key legislations governing intellectual property in India and which are applicable to our Company are the Patents Act, 1970, Copyright Act, 1957, the Designs Act, 2000 and the Trade Marks Act, 1999. These enactments provide for the protection of intellectual property by imposing civil and criminal liability for infringement. In addition to the domestic laws, India is party to several international intellectual property related instruments including the Patent Cooperation Treaty, 1970, the Paris Convention for the Protection of Industrial Property, 1883, the Berne Convention for the Protection of Literary and Artistic Works, 1886, the Universal Copyright Convention adopted at Geneva in 1952, the International Convention for the Protection of Performers, Producers of Phonograms and Broadcasting Organizations, 1961, and as a member of the World Trade Organisation, India also is a signatory to the Agreement on Trade Related aspects of Intellectual Property Rights (“**TRIPS**”).

### **Other Laws**

***Special Economic Zones Act, 2005 (“SEZ Act”) and the Special Economic Zone Rules, 2006 (“SEZ Rules”)***

A SEZ is a specifically delineated duty free enclave, deemed to be a foreign territory for the purposes of trade as well as duties and tariffs. A board of approval has been set up under the SEZ Act, which is responsible for promoting the SEZ and ensuring its orderly development. The SEZ Rules prescribe the procedure for the operation and maintenance of a SEZ and for setting up and conducting business therein.

***Export Promotion Capital Goods Scheme (“EPCG Scheme”)***

The objective of the EPCG Scheme under the Foreign Trade Policy 2015-20 is to promote the import of capital goods for producing quality goods and services in India, thereby enhancing India’s manufacturing competitiveness. The EPCG Scheme allows import of capital goods for pre-production, production and post production at zero customs duty, subject to an export obligation equivalent to six times of duties, taxes and cess saved on capital goods, to be fulfilled in six years reckoned from date of issue of authorisation. The EPCG Scheme covers manufacturer exporters with or without supporting manufacturer(s)/ vendor(s), merchant exporters tied to supporting manufacturer(s) and service providers.

***Remission of Duties and Taxes on Export Products Scheme (“RODTEP Scheme”)***

Prior to January 1, 2021, the Merchandise Exports from India Scheme (“MEIS”) was in force pursuant to which, the Government provided duty benefits depending on the product and the country of export. However, the Ministry of Finance, GoI has discontinued MEIS with effect from January 1, 2021 and announced RODTEP Scheme for exporters. RODTEP scheme will ensure that the exporters receive the refunds on the embedded taxes and duties that were previously non-recoverable. RODTEP scheme allows the exporter for the payment of import duty or sell such duty credit scrips in the open market to other importers.

## HISTORY AND CERTAIN CORPORATE MATTERS

### Brief history of our Company

Our Company was incorporated as “Uniparts India Limited” under the Companies Act, 1956 at Delhi, pursuant to a certificate of incorporation dated September 26, 1994 issued by the RoC. Our Company received a certificate of commencement of business on September 7, 1998 from the RoC.

### Changes in the Registered Office

Our registered office was originally located at 34, Regal Building, Parliament Street, New Delhi 110 001, India. Pursuant to a resolution of the Board dated December 6, 2002, the Registered Office was shifted from 34, Regal Building, Parliament Street to Gripwel House, Block 5, Sector C 6 & 7, Vasant Kunj, New Delhi 110 070, India with effect from December 6, 2002, for operational convenience.

### Main objects of our Company

The main objects contained in the Memorandum of Association of our Company are as follows:

- To manufacture, sale and export of precision engineering products and allied engineering products.*
- To manufacture, produce, roll, re-roll, cast, melt, forge, draw, mould, press, process, introduce, formulate, extend, test, research, weld, hire lease, meet out, repair, construct, assemble galvanize, head, temper, anneal, hard, machine, master, refine, associate, joint, improve exchange, polish, design, electroplate, import, export, supply, trade, stock, purchase, sell, and/or otherwise deal in any or all kinds of wrought iron, aluminium, copper, brass, zinc, iron, steel, nickel, lead, bronze, tin, chromium, cobalt, manganese, anodes, minerals, white and yellow metals and all other kinds of ferrous and non-ferrous metal in any form and/or kinds and/or shape including ingots, bars, solids, some, hollows, plates, sheets, scraps, dusts ashes, wastes seconds, defectives, liquids, powders, ores, minerals, and various type of cold and/or hot rolled and re-rolled sections, castings, mouldings, forgings, drawings, malleables, strips, coils, wires, balls, hardwares, metalwares, furnitures, boilers, machine tools, and accessories, tools, parts and equipments of automobiles, turbines, engines, machines and equipments.*
- To act as exporters and importers and traders of any kinds of materials, commodities, goods and articles whether raw, semi manufactured or completely manufactured in India or abroad.*

The main objects as contained in the Memorandum of Association enable our Company to carry on the business presently being carried out.

### Amendments to our Memorandum of Association in the last 10 years

Set forth below are details of the changes made to our Memorandum of Association of our Company in the last 10 years:

<b>Date of Shareholders' resolution/ Effective date</b>	<b>Details of amendment</b>
September 10, 2013	Amendment to Clause V of the Memorandum of Association to reflect increase in authorised share capital from ₹ 250,000,000 divided into 25,000,000 Equity Shares of ₹ 10 each to ₹ 600,000,000 divided into 60,000,000 Equity Shares of ₹ 10 each.
November 27, 2018	Amendments to the Memorandum of Association for compliance with Companies Act, 2013.

### Major events in the history of our Company

The table below sets forth the key events in the history of our Company.

Calendar Year	Particulars
1994	Incorporation of our Company
2000	Commenced sales to domestic OEMs in agriculture sector in India and developed our 3PL OEM product vertical Established the first facility in Noida
2001	Commenced sales to John Deere in India
2002	Commenced sales to John Deere in Spain
2003	Commenced sales to John Deere in the USA
2004	Commenced sales to OEMs in Japan
2005	Consolidated various businesses into our Company including those of M/s Gripwel Fasteners, Farmparts Company and SKG Engineering Private Limited Incorporated UUL as a wholly owned subsidiary and acquired a majority stake in UOI Acquired a manufacturing and distribution facility in the USA, in Eldridge, Iowa Commenced sales to OEMs in the construction sector in the USA Set up a warehousing and distribution facility in Augusta, Georgia
2006	Commenced manufacturing products for the PMP vertical in India
2007	Acquired the balance equity stake in UOI Acquired 50% + 1 share equity interest in Kavee (a joint venture with Kramp), which owned 100% interest in Uniparts Kavee Services B.V. Ashoka and Ambadevi made an equity investment in our Company Consolidated the business of Sweaty Spirit Apparel Limited (formerly known as Ace Tractor Parts Limited) into our Company Started manufacturing hydraulic cylinder components in one of the Noida facilities
2008	Commenced operations at the manufacturing facility located at Visakhapatnam, Andhra Pradesh GFPL became a wholly owned subsidiary of our Company
2010	Set up a warehousing and distribution facility in Hennef, Germany
2011	Started sales to the hydraulics market in USA from the manufacturing facility located at Visakhapatnam, Andhra Pradesh
2012	Commenced sale of components for the European construction OEM market
2013	Sold our entire equity interest in Kavee, with effect from April 1, 2012, to Kramp
2017	Added raw material storage space in Noida
2018	Commenced sales to Kobelco Added warehousing space at our facility in Augusta, USA Added additional distribution centre and office space in Noida Moved the warehousing facility of UUL to new larger leased location in Richmond County, Georgia

## Awards and Accreditations

The table below sets forth key awards and accreditations received by our Company and its Subsidiaries.

Calendar Year	Particulars
1998	UOI was awarded with (i) outstanding supplier performance; and (ii) recognition to the people of Olsen for their excellence in quality, teamwork and customer service, by Dubuque Works
2000	UOI was awarded with '10 Year Hall of Fame' (1991 – 2000) by John Deere Davenport Works
2002	Our Company was awarded with 'All India Certificate of Export Excellence' in recognition of achieving highest exports during 2001–2002 amongst SSI units in the Agricultural Machinery Panel by Engineering Export Promotion Council GFPL was awarded with 'All India Trophy for Highest Exporters' in the category of capital goods exporters – SSI during 2001 – 2002 by Engineering Export Promotion Council
2003	Our Company was awarded with 'All India Certificate of Export Excellence' in recognition of achieving highest exports during 2002–2003 amongst SSI units in the Agricultural Machinery Panel by Engineering Export Promotion Council
2005	UOI was awarded with '15 Year Hall of Fame' (1991–2005) by John Deere
2007	Our Company was awarded with 'All India Award for Export Excellence' for special contribution for highest growth in exports as large enterprise by Engineering Export Promotion Council
2008	Our Company was awarded with a gold trophy for 'Top Exporter of the year' 2007-2008 by Engineering Export Promotion Council
2010	Recognition at JCB Annual Supplier Conference by JCB India Limited
2013	Our Company won the first prize at CII Kaizen Competition
2014	Our Company was awarded with 'Best Supplier Award' for overall performance by Tractors and Farm Equipment Limited

Calendar Year	Particulars
	Our Company was awarded with 'Kubota India GM Award'
2015	Our Company was ranked at 432 by the Fortune India Next 500
	Our Company was awarded at the 6 <sup>th</sup> National Kaizen Competition with 'Special Category Award' for energy saving, poka yoke and environment by Chamber of Industrial and Commercial Undertaking
2016	Uniparts Group was awarded with 'Company with Great Managers' Trophy at the Great Manager Awards
	Our Company was awarded at the 7 <sup>th</sup> National Kaizen Competition with Special Kaizen Award by Chamber of Industrial and Commercial Undertaking
2017	Our Company was awarded with 'Innovative use of Training and Development as an HR Initiative for OD' by Global Training Development Leadership
2018	Our Company was awarded two awards at the 9 <sup>th</sup> National Kaizen Competition by Chamber of Industrial & Commercial Undertaking.
	Our Company was awarded with 'Special Trophy for Excellence in Exports of MEIS items 2015-20 Large Enterprise' by Engineering Export Promotion Council
	Our Company was awarded with 'Best Supplier Award' for outstanding contribution in co-creating value by TAFE
	Our Company was awarded with 'Excellence in Risk Mitigation' as runners up
	Our Company was awarded Star Performer award under large enterprise category for product group – Automobile Components for year 2017-18 by EEPC India (formerly, the Engineering Export Promotion Council)
2019	Our Company was awarded with 'Overall Excellence in Procurement and Sourcing Cost Reduction' in Procurement Tech Summit and Awards 2019
	Our Company won a silver trophy at the CII National Kaizen Circle Competition 2019
2020	Our Company won two silver trophies at the 11th National Kaizen Competition 2020 conducted by Chamber of Industrial & Commercial Undertaking, under the category of 'Low-Cost Automation in Tapping Process'
	Our Company was awarded 'Most Versatile Supplier 2020' by Kubota India

### Holding company

As on the date of this Draft Red Herring Prospectus, our Company has no holding company.

### Time and cost overrun

In August 2005, a warehouse owned by UUL located in Augusta, Georgia collapsed during its construction. The building was thereafter re-constructed and operations were started in 2007. During this period, warehousing operations of UUL were carried out from a public warehouse. We incurred warehousing charges for use of the public warehouse as well as additional legal fees.

Except as aforementioned, our Company and our Subsidiaries have not experienced any significant time and cost overrun in relation to the setting up of our manufacturing facilities and warehouses. Such time/ cost overruns involve risks and uncertainties. See "***Risk Factors - Activities involving our manufacturing process can be dangerous and can cause injury to people or property in certain circumstances. A significant disruption at any of our manufacturing facilities may adversely affect our production schedules, costs, sales and ability to meet customer demand***" on page 37.

### Defaults or re-scheduling of borrowings with financial institutions/banks.

For details pertaining to defaults by our Subsidiary, UOI, see "***Risk Factors – A failure to comply with financial and other restrictive covenants imposed on us under our financing agreements may cause us to default on these agreements, which may adversely affect our ability to conduct our business and operations.***" on page 38.

### Subsidiaries

As on the date of this Draft Red Herring Prospectus, our Company has five direct Subsidiaries and one indirect Subsidiary, details of which are provided below. GFPL, UUL, UEBV, GCPL and UIG are our direct Subsidiaries. UOI, a wholly-owned subsidiary of UUL, is an indirect Subsidiary of our Company.



## 1. Gripwel Fasteners Private Limited (“GFPL”)

### Corporate Information

GFPL was incorporated as Unilink Engineering Private Limited on January 13, 2005 under the Companies Act, 1956 pursuant to a certificate of incorporation issued by the RoC. The name was subsequently changed to Gripwel Fasteners Private Limited and a fresh certificate of incorporation pursuant to change of name was issued by the RoC on December 19, 2011. Its registered office is at Gripwel House, Block 5, LSC Sector C 6 & 7, Vasant Kunj, New Delhi 110 070, India.

### Nature of Business

GFPL is engaged in the business of manufacturing, sale and export of 3PL, tractor attachment systems and other agricultural equipment components. GFPL is also engaged in servicing the after-market and OEM customers.

### Capital Structure

The share capital of GFPL is as follows:

Authorised	Aggregate Nominal Value
6,000,000 equity shares of ₹ 10 each	₹ 60,000,000
<b>Total</b>	<b>₹ 60,000,000</b>
Issued, subscribed and paid up	
5,759,842 equity shares of ₹ 10 each	₹ 57,598,420
<b>Total</b>	<b>₹ 57,598,420</b>

### Shareholding Pattern

The shareholding pattern of GFPL is as follows:

S. No.	Name of the shareholder	No. of equity shares of ₹ 10 each	Percentage of shareholding(%)
1.	Uniparts India Limited	5,759,841	100.00
2.	Gurdeep Soni*	1	Negligible
	<b>Total</b>	<b>5,759,842</b>	<b>100.00</b>

\* As a nominee of our Company.

## 2. Uniparts USA Limited (“UUL”)

### Corporate Information

UUL was incorporated on January 27, 2005 under the laws of the State of Delaware, USA. UUL’s company registration is 3918054. Its registered office is at 251 Little Falls Drive, City of Wilmington, County of New Castle, Delaware 19808, USA.

### Nature of Business

UUL is primarily engaged in the business of warehousing and providing services to its customers located in USA.

### Capital Structure

The share capital of UUL is as follows:

Authorised	Aggregate Nominal Value
300,000 common stock of USD 10 each	USD 3,000,000
800,000 convertible preferred stock of USD 10 each	USD 8,000,000
<b>Total</b>	<b>USD 11,000,000</b>
Issued, subscribed and paid up	
2,000 common stock of USD 10 each	USD 20,000

<b>Authorised</b>	<b>Aggregate Nominal Value</b>
800,000 convertible preferred stock of USD 10 each	USD 8,000,000
<b>Total</b>	<b>USD 8,020,000</b>

#### *Shareholding Pattern*

The shareholding pattern of UUL is as follows:

<b>S. No.</b>	<b>Name of the shareholder</b>	<b>No. of shares of USD 10 each</b>	<b>Percentage of shareholding (%)</b>
<b>A.</b>	<b><i>Common Stock</i></b>		
	Uniparts India Limited	2,000	100.00
<b>B.</b>	<b><i>Convertible Preferred Stock</i></b>		
	Uniparts India Limited	800,000	100.00
	<b>Total</b>	<b>8,02,000</b>	<b>100.00</b>

### **3. Uniparts Europe B.V. (“UEBV”)**

#### *Corporate Information*

UEBV was incorporated on January 22, 2007 under the laws of Netherlands. Its registered office is at Herikerbergweg 238, Luna Arena, 1101 CM, Amsterdam, Netherlands.

#### *Nature of Business*

UEBV is currently not engaged in any activity, although it is authorised to do production, manufacturing, sale, marketing and export of heavy and light engineering products and allied engineering products.

#### *Capital Structure*

The share capital of UEBV is as follows:

<b>Authorised</b>	<b>Aggregate Nominal Value</b>
1,500,000 shares of € 1 each	€ 1,500,000
<b>Total</b>	<b>€ 1,500,000</b>
<b>Issued, subscribed and paid up</b>	
1,100,000 shares of € 1 each	€ 1,100,000
<b>Total</b>	<b>€ 1,100,000</b>

#### *Shareholding Pattern*

The shareholding pattern of UEBV is as follows:

<b>S. No.</b>	<b>Name of the shareholder</b>	<b>No. of equity shares of €1 each</b>	<b>Percentage of shareholding (%)</b>
1.	Uniparts India Limited	1,100,000	100.00
	<b>Total</b>	<b>1,100,000</b>	<b>100.00</b>

### **4. Uniparts India GmbH (“UIG”)**

#### *Corporate Information*

UIG was founded on May 18, 2010 under the laws of Germany with a capital stock of € 100,000 and incorporated on June 18, 2010 under the laws of Germany. It is registered in the commercial register of the Local Court Seigburg, Germany, under the registration number HRB 11078. Its registered office is at Reutherstraße, 3, 53773, Hennef, Germany.

#### *Nature of Business*

UIG is primarily engaged in the business of trade of machine components for mobile machines and general mechanical engineering.

*Capital Structure*

The share capital of UIG is as follows:

<b>Authorised</b>	<b>Aggregate Nominal Value</b>
1 share of € 100,000 each	€ 100,000
<b>Total</b>	<b>€ 100,000</b>
<b>Issued, subscribed and paid up</b>	
1 share of € 100,000 each	€ 100,000
<b>Total</b>	<b>€ 100,000</b>

*Shareholding Pattern*

The shareholding pattern of UIG is as follows:

<b>S. No.</b>	<b>Name of the shareholder</b>	<b>No. of shares of € 100,000 each</b>	<b>Percentage of shareholding (%)</b>
1.	Uniparts India Limited	1	100.00
	<b>Total</b>	<b>1</b>	<b>100.00</b>

**5. Gripwel Conag Private Limited (“GCPL”)**

*Corporate Information*

GCPL was incorporated on December 6, 2021 under the Companies Act, 2013 pursuant to a certificate of incorporation issued by the RoC. Its registered office is at Plot No. 5, C-6&7, LSC Vasant Kunj, Delhi, Southwest Delhi 110 070, India.

*Nature of Business*

GCPL is primarily engaged in the business of manufacturing, selling and exporting of precision engineering and allied products.

*Capital Structure*

The share capital of GCPL is as follows:

<b>Authorised</b>	<b>Aggregate Nominal Value</b>
7,000,000 equity shares of ₹ 10 each	₹ 70,000,000
<b>Total</b>	<b>₹ 70,000,000</b>
<b>Issued, subscribed and paid up</b>	
3,000,000 equity shares of ₹ 10 each	₹ 30,000,000
<b>Total</b>	<b>₹ 30,000,000</b>

*Shareholding Pattern*

The shareholding pattern of GCPL is as follows:

<b>S. No.</b>	<b>Name of the shareholder</b>	<b>Number of shares of ₹10 each</b>	<b>Percentage of shareholding (%)</b>
1.	Uniparts India Limited	2,999,999	100.00
2.	Angad Soni*	1	Negligible
	<b>Total</b>	<b>3,000,000</b>	<b>100.00</b>

\* As a nominee of our Company

**6. Uniparts Olsen Inc. (“UOI”)**

*Corporate Information*

UOI was incorporated as ‘Olsen Engineering LP’ on April 22, 1998 under the laws of the State of Delaware, USA. Olsen Engineering LP was converted to ‘Olsen Engineering LLC’ on November 10, 2005 and then to ‘Uniparts Olsen Inc.’ on September 5, 2007. UUL acquired 50% plus one common stock ownership interest in UOI pursuant to an Investment-Cum-Unit Purchase Agreement dated November 11, 2005 between our Company, UUL, UOI, Kevin John Code, Dennis Francis DeDecker, Andrew Warren Code and James Norman Hallene. UOI became a wholly owned subsidiary of UUL on May 25, 2007 when UUL exercised its call option under the Investment-Cum-Unit Purchase Agreement. Its registered office is at Corp Trust Ctr. 1209, Orange Street, Wilmington, County of New Castle, Delaware 19801, USA.

#### *Nature of Business*

UOI is primarily engaged in the business of manufacturing, warehousing, and sale of all types of light engineering products and allied engineering products.

#### *Capital Structure*

The share capital of UOI is as follows:

<b>Authorised</b>	<b>Aggregate Nominal Value</b>
1,224,301 common stock of USD 1 each	USD 1,224,301
<b>Total</b>	<b>USD 1,224,301</b>
<b>Issued, subscribed and paid up</b>	
1,224,301 common stock of USD 1 each	USD 1,224,301
<b>Total</b>	<b>USD 1,224,301</b>

#### *Shareholding Pattern*

The shareholding pattern of UOI is as follows:

<b>S. No.</b>	<b>Name of the shareholder</b>	<b>Number of shares of USD1 each</b>	<b>Percentage of shareholding (%)</b>
1.	UUL	1,224,301	100.00
	<b>Total</b>	<b>1,224,301</b>	<b>100.00</b>

#### **Other Confirmations**

##### *Amount of accumulated profits or losses*

There are no accumulated profits or losses of our Subsidiaries not accounted for by our Company.

##### *Interest in our Company*

Except as provided in “**Our Business**” on page 149, none of our Subsidiaries have any business interest in our Company. For details of related business transactions between our Company and our Subsidiaries, see “**Financial Statements – Note 38 - Related Party Disclosure**” on page 306 .

##### *Common Pursuits*

Our Subsidiaries are either engaged in or are authorised by their respective constitutional documents to engage in the same line of business as that of our Company. Accordingly, as disclosed in “- **Subsidiaries**” above on page 182 and “**Financial Statements – Restated Financial Statements**” on page 212, there are common pursuits and common business interests among our Subsidiaries and our Company.

##### *Listing of our Subsidiaries*

None of our Subsidiaries have their securities listed on any stock exchange in India or abroad.

#### **Details regarding material acquisitions or divestments of business or undertakings, mergers, amalgamations or revaluation of assets in the last ten years**

Except as stated below, our Company has not made any material acquisitions or divestments of any business or undertaking, and has not undertaken any mergers, amalgamation or revaluation of assets in the last ten years.

## Disinvestment of Kavee

Our Company entered into a share purchase and shareholders' agreement dated January 22, 2007 with Kramp and Kavee pursuant to which Kramp sold all rights and title in 1,000,001 shares (constituting 50% +1 shares) of Kavee to Uniparts Europe B.V. for a total consideration of Euro 1,000,001. The agreement governed the rights and liabilities of the parties in connection with Kavee. In accordance with the agreement, the business affairs of Kavee as a joint venture were managed by a management board under the supervision of the supervisory board. Uniparts Europe B.V. and Kramp were each entitled to nominate two directors on the supervisory board, and one director each on the management board. The parties to the share purchase and shareholders' agreement entered into a deed of cessation dated January 24, 2013, effective from April 1, 2012, pursuant to which the joint venture was cancelled and the share purchase and shareholders' agreement was terminated. Further, the 1,000,001 shares which Uniparts Europe B.V. had purchased pursuant to share purchase and shareholders' agreement dated January 22, 2007 were purchased back by Kramp for a total consideration of Euro 725,000. For further details relating to the loss incurred as a result of this transaction, see "**Risk Factors - If we are unable to successfully identify and integrate acquisitions, our growth strategy and prospects may be adversely affected**" on page 45.

## Shareholders' Agreements and Other Agreements

### *Key terms of subsisting shareholders' agreements*

Our Company entered into a shareholders' agreement dated September 25, 2007 amongst our Promoters, Ambadevi and Ashoka (the "**Shareholders' Agreement**"), as amended by letter agreements dated September 7, 2010 and February 18, 2013, and the Amendment and Supplemental Deed (as defined below). Further, by a deed of accession dated May 31, 2012, Karan Soni became a party to the Shareholders' Agreement and by two separate deeds of accession, each dated July 4, 2012 Meher Soni became party to the Shareholders' Agreement. Further, a supplemental deed dated January 30, 2014 to the Shareholders' Agreement was entered into amongst our Promoters, Ambadevi, Ashoka, Karan Soni, Meher Soni and our Company (collectively, "**SHA Parties**"). The Shareholders' Agreement was executed pursuant to the provisions of the investment agreement dated September 13, 2007 entered into amongst the Promoters, Ambadevi, Ashoka and our Company ("**Investment Agreement**"), in order to regulate the relationship between the shareholders of our Company and the way in which our Company shall be managed.

The Shareholders' Agreement was amended by an amendment and termination agreement dated December 3, 2018 (the "**2018 Amendment Agreement**"), which provided that in the event the Company was unable to complete the listing and trading of its Equity Shares on the Stock Exchanges on or before September 30, 2019 or any other date mutually agreed between the parties, the 2018 Amendment Agreement would immediately terminate and the Shareholders' Agreement would immediately and automatically stand reinstated without any action by the parties. Accordingly, due to failure to complete the listing and trading of its Equity Shares on the Stock Exchanges before September 30, 2019, the 2018 Amendment Agreement automatically terminated without having any force and effect.

Subsequently, following transfers of 4,000,000 Equity Shares to the Karan Soni 2018 CG-Nevada Trust by Karan Soni, 3,700,000 Equity Shares to the Meher Soni 2018 CG-Nevada Trust by Meher Soni, and 5,595,090 Equity Shares to the Paramjit Soni 2018 CG-Nevada Trust by Paramjit Soni, trust agreements each dated November 15, 2018, deeds of accession each dated December 27, 2018 and a supplemental deed (to the Shareholders' Agreement) dated December 27, 2018 were entered into among the SHA Parties and Peak Trust Company-NV, followed by a letter agreement dated October 10, 2019 to incorporate references to the 2018 Amendment Agreement.

Thereafter, the Shareholders' Agreement, the three deeds of accession dated December 27, 2018, the supplemental deed dated December 27, 2018 and the letter agreement dated October 10, 2019 were consolidated into one amendment and supplemental deed dated December 7, 2020 ("**Amendment and Supplemental Deed**") entered into amongst Sarabjit Soni, Shrikant Nadkarni, Peak Trust Company – NV, Angad Soni, Arjun Soni, Pamela Soni, Tanya Kohli and the SHA Parties. Pursuant to the Amendment and Supplemental Deed Gurdeep Soni transferred 1,020,480 Equity Shares to Pamela Soni, 1,950,000 Equity Shares to Angad Soni, 1,990,000 Equity Shares to Arjun Soni and 1,000,000 to Tanya Kohli. Further, Paramjit Singh Soni, Karan Soni and Mehar Soni transferred 800,000, 1,200,000 and 1,500,000 Equity Shares respectively to each of their trust. Also, Ambadevi and Ashoka recorded the additional investments that were already made by them as a part of

the investor subscription shares and amount (i.e., inclusion of 1,555,806 Equity Shares at an aggregate amount of USD 1,473,300 through rights issue and 4,667,417 Equity Shares through bonus issue).

The Shareholders' Agreement confers certain rights upon the Investor Selling Shareholders including, *inter alia*, (i) the right to appoint a nominee director; and (ii) certain reserved matters in the meetings held by the Board and Shareholders for which the Investor Selling Shareholders and the Nominee Director have affirmative voting rights. The SHA also provides for restrictions on transfer of Equity Shares by the shareholders of the Company.

Pursuant to the amendment and termination agreement dated April 19, 2022, ("**2022 Amendment and Termination Agreement**") the SHA Parties have waived, suspended or suitably amended certain inter se rights, to the extent relevant and required in respect of the Offer. In the event the Offer is not completed by September 30, 2022, the 2022 Amendment and Termination Agreement shall terminate and the SHA shall be reinstated to the position prior to the 2022 Amendment and Termination Agreement. In the event the Offer is completed by September 30, 2022, the SHA shall immediately terminate without any further action by the parties with effect from the commencement of listing and trading of the Equity Shares on the Stock Exchanges pursuant to the Offer.

#### *Shareholders' Agreement among Olsen Investors and our Company*

Our Company entered into a shareholders' agreement dated May 25, 2007 with Kevin J. Code, Dennis F. DeDecker, Andrew Code, James Hallene, Mark Dawson, Melvin K. Gibbs, Marc C. Dorau, Bradley Miller, Walter J. Gruber, Mary L. Arp, Diana Craig, Wendy R. Hammen, Craig A. Johnson and Misty Marie Gracia (collectively, the "**Olsen Investors**") along with Gurdeep Soni and Paramjit Singh Soni. This shareholders' agreement governs the rights and obligations of such persons as shareholders in our Company. Any transfer of equity shares by the Olsen Investors is subject to a right of first refusal in favour of Gurdeep Soni and Paramjit Singh Soni, our Promoters. The Olsen Investor proposing to transfer its equity shares will be required to notify our Promoters with the details regarding the transfer ("**Transfer Notice**"), and each of our Promoters will have a right of first refusal to purchase, by himself or by a purchaser nominated by him, the pro rata share (based on his shareholding) of the equity shares being transferred. In the event a Promoter does not elect to purchase the equity shares, the other Promoter will have the right to purchase such equity shares. In the event our Promoters do not exercise the right of first refusal, the transferring shareholder may transfer all the equity shares to a third party purchaser on the terms and conditions as set out in the Transfer Notice. This shareholders' agreement will automatically terminate upon the completion of the IPO of our Company.

#### **Agreements with Key Managerial Personnel, Director, Promoter or any other employee**

There are no agreements entered into by a Key Managerial Personnel or Director or Promoter or any other employee of our Company, either by themselves or on behalf of any other person, with any shareholder or any other third party with regard to compensation or profit sharing in connection with dealings in the securities of our Company.

#### **Key terms of other subsisting material agreements**

Our Company has not entered into any other subsisting material agreements including with strategic partners, joint venture partners, and/or financial partners other than in the ordinary course of business of our Company.

#### **Significant financial or strategic partnerships**

Our Company does not have any financial and strategic partners as on the date of this Draft Red Herring Prospectus.

## OUR MANAGEMENT

In terms of the Companies Act and our Articles of Association, our Company is required to have not less than three Directors and not more than 15 Directors. As on the date of this Draft Red Herring Prospectus, our Board comprises eight Directors, including two Executive Directors, one Non-Executive Director, one Nominee Director and four Independent Directors (including one woman director).

The following table sets forth details regarding our Board as of the date of this Draft Red Herring Prospectus:

Sr. No.	Name, designation, address, occupation, date of birth, period and directorship and DIN	Age (years)	Directorships in other companies
1.	<p><b>Gurdeep Soni</b></p> <p>Designation: Chairman and Managing Director</p> <p>Address: 142 Church Road, Avenue-7, Vasant Kunj, South West Delhi, Delhi 110 070</p> <p>Occupation: Business</p> <p>Date of birth: March 18, 1955</p> <p>Term: Three years from April 1, 2021, and liable to retire by rotation</p> <p>Period of Directorship: Since September 26, 1994</p> <p>DIN: 00011478</p>	67	<p><i>Indian Companies:</i></p> <ol style="list-style-type: none"> <li>1. Amazing Estates Private Limited</li> <li>2. Bluebells Homes Private Limited (formerly known as Oilintec Private Limited)</li> <li>3. G K P Farms Private Limited</li> <li>4. GFPL</li> <li>5. SGA Trading Private Limited</li> <li>6. Silveroak Estate Private Limited</li> <li>7. SKG Engineering Private Limited</li> <li>8. Sweaty Spirit Apparel Limited</li> <li>9. Tima Trading Private Limited</li> <li>10. Sepoy Drinks Private Limited</li> <li>11. GCPL</li> </ol> <p><i>Foreign Companies:</i></p> <ol style="list-style-type: none"> <li>1. UOI</li> <li>2. UUL</li> <li>3. UEBV</li> </ol>
2.	<p><b>Paramjit Singh Soni</b></p> <p>Designation: Executive Director and Vice Chairman</p> <p>Address: 596, High Hampton, Dr. Martinez, GA 30907 9183, USA</p> <p>Occupation: Business</p> <p>Date of birth: October 9, 1960</p> <p>Term: Five years with effect from April 1, 2022 and liable to retire by rotation</p> <p>Period of Directorship: Director since September 26, 1994</p> <p>DIN: 00011616</p>	61	<p><i>Indian Companies</i></p> <ol style="list-style-type: none"> <li>1. Amazing Estates Private Limited</li> <li>2. G K P Farms Private Limited</li> <li>3. GFPL</li> <li>4. SKG Engineering Private Limited</li> <li>5. Tima Trading Private Limited</li> </ol> <p><i>Foreign Companies</i></p> <ol style="list-style-type: none"> <li>1. UOI</li> <li>2. UUL</li> <li>3. UEBV</li> </ol>
3.	<p><b>Herbert Coenen</b></p> <p>Designation: Non-Executive Director</p> <p>Address: Vinxeler Street, 74A, Koenigswinter, 53639, Germany</p> <p>Occupation: Service</p> <p>Date of birth: September 7, 1961</p> <p>Term: Liable to retire by rotation</p>	60	<p><i>Indian Companies</i></p> <p>Nil</p> <p><i>Foreign Companies</i></p> <ol style="list-style-type: none"> <li>1. UIG</li> <li>2. UOI</li> </ol>

Sr. No.	Name, designation, address, occupation, date of birth, period and directorship and DIN	Age (years)	Directorships in other companies
	Period of Directorship: Director since January 12, 2013 DIN: 00916001		
4.	<b>Harjit Singh Bhatia</b> * Designation: Nominee Director Address: 18, Bishopsgate, Singapore, Singapore 249981 Occupation: Professional Date of birth: October 8, 1949 Term: Not liable to retire by rotation Period of Directorship: Since May 21, 2021 DIN: 02285424	72	<i>Indian Companies</i> 1. GFPL 2. International Asset Reconstruction Company Private Limited  <i>Foreign Companies</i> 1. Asia Growth Capital Advisors (Singapore) Pte. Limited 2. Asia Growth Capital Advisors (HK) Pte. Limited 3. Polygel Life Sciences Pte. Limited 4. UUL
5.	<b>Alok Nagory</b> Designation: Independent Director Address: 7/197, Swarup Nagar, Kanpur 208 002, India Occupation: Business Date of birth: December 16, 1955 Term: Five years with effect from August 23, 2019 Period of Directorship: Since August 23, 2014 DIN: 00478140	66	<i>Indian Companies</i> 1. Diversified Engineering Corporation Private Limited 2. Nagory Foster Private Limited 3. Nagory Investments Private Limited 4. The India Thermit Corporation Limited 5. Thermit - Thormahlen India Limited  <i>Foreign Companies</i> Nil
6.	<b>Sharat Krishan Mathur</b> Designation: Independent Director Address: E-323/2, Greater Kailash – I, New Delhi 110 048, India Occupation: Business Date of birth: April 27, 1957 Term: Five years with effect from April 1, 2019 Period of Directorship: Director since November 29, 2013 DIN: 01217742	64	<i>Indian Companies</i> 1. GFPL 2. Insight Alpha Research & Solutions Private Limited  <i>Foreign Companies</i> 1. UOI 2. UUL
7.	<b>Shradha Suri</b> Designation: Independent Director Address: N-101, Panchsheel Park, New Delhi 110 017, India Occupation: Business	44	<i>Indian Companies</i> 1. Asahi India Glass Limited 2. Automotive Component Manufacturers Association of India 3. Fibcom India Limited (amalgamated with Primatel Fibcom Limited) 4. Globalydk Electric Private Limited 5. Prima Infratech Private Limited



Sr. No.	Name, designation, address, occupation, date of birth, period and directorship and DIN	Age (years)	Directorships in other companies
	Date of birth: March 22, 1978 Term: Five years with effect from August 23, 2019 Period of Directorship: Director since August 23, 2014 DIN: 00176902		6. Primatel Fibcom Limited 7. R. R. Holdings Limited 8. Rohan Motors Limited 9. Sona BLW Precision Forgings Limited 10. Subros Limited  <i>Foreign Companies</i>  Nil
<b>8.</b>	<b>Sanjeev Kumar Chanana</b>  Designation: Independent Director  Address: House No-B 5/6, Africa Avenue, Safdarjung Enclave, Vasant Vihar, South West Delhi, Delhi 110 029, India  Occupation: Professional  Date of birth: August 10, 1953  Term: Five years with effect from February 17, 2022  Period of Directorship: Director since February 17, 2022  DIN: 00112424	68	<i>Indian Companies</i>  1. IIFCL Asset Management Company Limited  <i>Foreign Companies</i>  Nil

*\*As a nominee of Ashoka and Ambadevi. Harjit Singh Bhatia will step down from our Board upon the listing of our Equity Shares on the Stock Exchanges in accordance with the terms of the SHA.*

### **Brief profiles of our Directors**

**Gurdeep Soni** is the Chairman and Managing Director of our Company and has been associated with our Company since its incorporation. He was appointed as a Director of our Company on September 26, 1994. He holds a master's degree in management studies from the Birla Institute of Technology and Science, Pilani. He has 42 years of work experience including 27 years of experience in different roles within the Uniparts Group. He has been actively involved in the day-to-day operations of our Company and is responsible for the after-market business of the Uniparts Group.

**Paramjit Singh Soni** is an Executive Director and Vice Chairman of our Company and has been associated with our Company since its incorporation. He was appointed as Director of our Company on September 26, 1994. He holds a bachelor's degree in commerce from the University of Delhi. He has 40 years of work experience including 27 years of experience as a Director of our Company and is presently based in the USA. He is responsible for the OEM business of the Uniparts Group and also actively involved in the formulation of corporate strategy and planning and concentrates on the business growth and diversification plans of our Company.

**Herbert Coenen** is a Non-Executive Director of our Company. He was appointed as a Director of our Company on January 12, 2013. He holds a diploma from the University of Applied Science, Cologne in mechanical engineering. He has over 35 years of work experience, of which 20 years were with GKN Walterscheid GmbH. He is associated with the Uniparts Group since May, 2005 and has played a key role in business development, business expansion and technology adoption of our Company and its Subsidiaries outside India. He is also the managing director of our Subsidiary, Uniparts India GmbH.

**Harjit Singh Bhatia** is a Nominee Director of our Company and a nominee of Ashoka and Ambadevi on our Board. He was appointed as a Nominee Director of our Company on May 21, 2021. He holds a master's degree in commerce from the University of Allahabad and a master's degree in business administration from the University of Delhi. He is also an associate of the Indian Institute of Bankers and has been awarded the GE Company Certification as a GE Green Belt in Six Sigma. He has over 41 years of experience across various

sectors, and has previously been associated with the State Bank of India, GE Healthcare, Credit Suisse Services (Guernsey) Limited, Deutsche Bank and PineBridge Investments Singapore Limited.

**Alok Nagory** is an Independent Director of our Company. He was appointed as a Director of our Company on August 23, 2014. He holds a master's of science degree in biological sciences from the Birla Institute of Technology and Science, Pilani. He has about 43 years of experience in international business development, joint ventures and acquisitions in India Thermit Corporation Limited. He is currently the chairman and the managing director of The India Thermit Corporation Limited.

**Sharat Krishan Mathur** is an Independent Director of our Company. He was appointed as a Director of our Company on November 29, 2013. He holds a bachelor's degree in engineering from the Birla Institute of Technology and Science, Pilani. He has over 36 years of experience in managing complex outsourcing, remote project management and process re-engineering. He has previously worked with reputed companies in different sectors such as Maclean Power Systems. He co-founded Insight Alpha in 2008, a primary research firm focused on finding relevant experts dedicated to providing institutional investors with access to leading industry professionals in India and South East Asia.

**Shradha Suri** is an Independent Director of our Company. She was appointed as a Director of our Company on August 23, 2014. She holds a master's degree in science from the London School of Economics and Political Science, University of London and a master's degree in science (having followed a programme of advanced study in international marketing and management) from the University of Leeds. She has over 21 years of experience and has played a key role in management of affairs, formulation and implementation of policies, directing strategy towards profitable growth for Subros Limited. She is currently the chairperson and managing director of Subros Limited a part of the Suri Group, which has interests in a diverse range of businesses ranging from automotive components, cooling systems, hospitality, telecom and education. She is also the co-chairperson of the Automotive Components Manufacturers Association of India.

**Sanjeev Kumar Chanana** is an Independent Director of our Company. He was appointed as a Director of our Company on February 17, 2022. He holds a bachelor's degree in law and a master's degree in arts from the University of Delhi. He is also a member of the Institute of Company Secretaries of India. At present, he is associated with the National Pension Scheme Trust as a trustee. He has over 25 years of work experience in the field of investments, technology and corporate governance and has previously been associated with the Oriental Insurance Company Limited and the New India Assurance Company Limited.

#### **Relationship between our Directors and Key Managerial Personnel**

Except for Gurdeep Soni and Paramjit Singh Soni, who are brothers, none of our Directors and Key Managerial Personnel are related to each other.

#### **Remuneration to Executive Directors**

Our Company has paid the following remuneration to our Executive Directors in Fiscal 2022:

S. No.	Name of Executive Director	Total remuneration (in ₹ million)
1.	Gurdeep Soni	Nil
2.	Paramjit Singh Soni	Nil
	<b>Total</b>	Nil

#### **Terms of Appointment of our Executive Directors**

##### **Gurdeep Soni**

Pursuant to a resolution of our Board dated August 29, 2020 and a resolution of our Shareholders dated September 30, 2020, Gurdeep Soni was last re-appointed as our Chairman and Managing Director, for a term of three years from April 1, 2021 till March 31, 2024.

Gurdeep Soni is receiving remuneration from our Subsidiary, GFPL and will continue to receive remuneration from GFPL. Additionally, pursuant to a resolution of our Board dated April 16, 2022 and of our Shareholders dated April 23, 2022, Gurdeep Soni will also be entitled to receive remuneration from our Company, for the period between April 1, 2022 and March 31, 2024, provided that the maximum remuneration payable to him shall not exceed ₹ 50.00 million or 2.5% of the net profits of our Company, whichever is higher, calculated in accordance

with applicable law. Within these limits, Gurdeep Soni shall be entitled to commission/ex-gratia/bonus of 1% of the consolidated profit of the Company, subject to applicable laws and approval of the Shareholders, pursuant to letter dated April 23, 2022 from our Company. For further details, see “– **Remuneration paid or payable to our Directors from our Subsidiaries**” on page 193.

### **Paramjit Singh Soni**

Pursuant to a resolution of our Board dated August 29, 2020 and a resolution of our Shareholders dated September 30, 2020, Paramjit Singh Soni was last re-appointed as our Executive Director, liable to retire by rotation. Pursuant to a resolution of our Board dated April 16, 2022 and a resolution of our Shareholders dated April 23, 2022, Paramjit Singh Soni was redesignated as Executive Director and Vice Chairman from April 1, 2022 to March 31, 2027, liable to retire by rotation.

Paramjit Singh Soni is receiving remuneration from our Subsidiary, UUL and will continue to receive remuneration from UUL. Additionally, pursuant to a resolution of our Board dated April 16, 2022 and of our Shareholders dated April 23, 2022, Paramjit Singh Soni will also be entitled to receive remuneration from our Company, for the period between April 1, 2022 and March 31, 2025, provided that the maximum remuneration payable to him shall not exceed ₹ 50.00 million or 2.5% of the net profits of our Company, whichever is higher, calculated in accordance with applicable law. Within these limits, Paramjit Singh Soni shall be entitled to commission/ex-gratia/bonus of 1% of the consolidated profit of the Company, subject to applicable laws and approval of the Shareholders, pursuant to letter dated April 23, 2022 from our Company. For further details, see “– **Remuneration paid or payable to our Directors from our Subsidiaries**” on page 193.

### **Remuneration to Non-Executive Directors and Independent Directors**

The details of the compensation paid to the Independent Directors by our Company during Fiscal 2022 is as follows:

S. No.	Name of Independent Director	Sitting fees paid (in ₹ million)	Commission paid (in ₹ million)	Total compensation (in ₹ million)
1.	Alok Nagory	0.18	Nil	0.18
2.	Sharat Krishan Mathur	0.41	Nil	0.41
3.	Shradha Suri	0.20	Nil	0.20
4.	Sanjeev Kumar Chanana	0.10	Nil	0.10

Each Independent Director is entitled to receive sitting fees of ₹ 75,000 per meeting for attending each meeting of our Board and ₹ 25,000 per meeting for attending each meeting of our committees, pursuant to a resolution of the Board dated March 22, 2022, within the limits prescribed under the Companies Act, 2013. The travel expenses for attending meetings of the Board or a committee thereof, site visits and other Company related expenses are borne by our Company, from time to time.

Our Non-Executive Director, Herbert Coenen has not received any remuneration from our Company during Fiscal 2022.

Our Nominee Director is not entitled to receive any remuneration from our Company and has not been paid any remuneration during Fiscal 2022.

### **Remuneration paid or payable to our Directors from our Subsidiaries**

Except as disclosed below, none of our Directors have been paid any remuneration or sitting fees from our Subsidiaries, including contingent or deferred compensation accrued for the year during Fiscal 2022:

S. No.	Name of Director	Name of Subsidiary	Total remuneration/sitting fees (in ₹ million)
1.	Gurdeep Soni	GFPL	25.83
2.	Paramjit Singh Soni	UUL	39.12
3.	Herbert Coenen	UIG	23.10
4.	Sharat Krishan Mathur	GFPL	0.08

### **Gurdeep Soni**

Gurdeep Soni is entitled to remuneration from our Subsidiary, GFPL pursuant to an employment agreement between Gurdeep Soni and GFPL dated April 1, 2016 as last amended on April 1, 2021. Details of his employment are provided below:

Particulars	Remuneration
Salary	Salary to be paid monthly, and PF, gratuity, leave encashment will be included with the cost to GFPL, which shall be a maximum monthly salary of ₹ 2.60 million for Fiscal 2023;
Annual increment	Entitled to annual increment as per the India Inflation Linked Salary Increase in accordance with the performance management policy of GFPL. The annual increment shall be recommended by the Nomination and Remuneration Committee of GFPL and approved by its board of directors.
Perquisites and benefits	Benefits such as medical expenses, personal accident insurance, club fees, conveyance facilities, communication facilities and reimbursement of expenses, as per the employment agreement
Bonus	Such sum as may be decided by the board of directors or a committee thereof, based on achievement of performance of certain parameters as laid down by the board of directors or a committee thereof.
Notice period	Six months, unless otherwise agreed by the board of GFPL.

### Paramjit Singh Soni

Paramjit Singh Soni is entitled to remuneration from our Subsidiary, UUL pursuant to an employment agreement between Paramjit Singh Soni and UUL dated August 27, 2014, as last amended on April 21, 2022. Details of his employment are provided below:

Particulars	Remuneration
Salary	Salary to be paid monthly, and the base salary payable shall be USD 56,000 per month for Fiscal 2023.
Annual increment	Entitled to annual increment as per the USA Inflation Linked Salary Increase in accordance with the performance management policy of UUL. The annual increment shall be as decided and agreed by UUL.
Perquisites and benefits	Benefits such as medical expenses, personal accident insurance, club fees, conveyance facilities, communication facilities and reimbursement of expenses, as per the employment agreement.
Bonus	Such sum as may be decided by the board of directors or a committee thereof, based on achievement of performance of certain parameters as laid down by the board of directors or a committee thereof.

### Herbert Coenen

Herbert Coenen is entitled to remuneration from our Subsidiary, UIG pursuant to an employment agreement between Herbert Coenen and UIG dated January 1, 2012 as amended by letter dated April 1, 2014 and November 20, 2015. Details of his employment are provided below:

Particulars	Remuneration
Salary	Annual salary of Euro 166,390 payable in equal monthly instalments.
Perquisites and benefits	Performance linked incentive up to Euro 69,329, reimbursement of expenses, medical insurance and other insurances. Additionally, he is entitled to 50% of his annual salary and guaranteed bonus upon termination of his employment as non-compete fee for a period of one year, as per the employment agreement.
Bonus	Guaranteed bonus of Euro 28,548 to be paid once a year on or before the closure of the next Fiscal.

### Bonus or profit sharing plan for our Directors

Our Company does not have a bonus or profit sharing plan for our Directors.

### Contingent and deferred remuneration payable to our Directors

There is no contingent or deferred compensation payable to our Directors, which does not form part of their remuneration.

### Shareholding of our Directors in our Company

As per our Articles of Association, our Directors are not required to hold any qualification shares.

Except as disclosed in “*Capital Structure – Shareholding of Directors and Key Managerial Personnel in our Company*” on page 96, none of our Directors hold any Equity Shares in our Company as on the date of this Draft Red Herring Prospectus.

#### **Arrangement or understanding with major shareholders, customers, suppliers or others**

Apart from Harjit Singh Bhatia, nominated to our Board by Ambadevi and Ashoka, pursuant to the Shareholders’ Agreement, none of our Directors have been appointed pursuant to any arrangement or understanding with our major shareholders, customers, suppliers or others. For further details, see “*History and Certain Corporate Matters – Shareholders’ Agreements and Other Agreements*” on page 187.

#### **Service contracts with Directors**

Except for our Executive Directors and Non-Executive Director, Herbert Coenen, who are entitled to statutory benefits upon termination of their employment from the relevant Subsidiaries or on retirement, no Director has entered into a service contract with our Company pursuant to which they are entitled to any benefits upon termination of employment. Herbert Coenen is entitled to non-compete fee upon termination of his employment from our Subsidiary, UIG. For further details, see “- *Remuneration to Executive Directors*” on page 192.

#### **Interest of Directors**

All our Directors may be deemed to be interested to the extent of fees, if any, payable to them for attending meetings of the Board or a committee thereof, as well as to the extent of other remuneration and reimbursement of expenses, if any, payable to them, and to the extent of remuneration paid to them for services rendered as an officer or employee of our Company or our Subsidiaries. Our Directors may also be interested to the extent of Equity Shares, if any (together with dividends in respect of such Equity Shares), held by them or held by the entities in which they are associated as promoters, directors, partners, proprietors, beneficiaries or trustees or held by their relatives. Herbert Coenen may be deemed to be interested to the extent that he has been granted ESOPs pursuant to ESOP 2007.

For further details regarding the shareholding of our Directors, see “*Capital Structure - Shareholding of Directors and Key Managerial Personnel in our Company*” on page 96.

Our Company and our Subsidiary, GFPL have entered into separate lease agreements dated January 17, 2014 with Soni Holdings (Partnership Firm) for lease of (i) certain portion of the building of our Registered Office; (ii) a certain portion of the building of the registered office of GFPL for a period of nine years with effect from November 1, 2013 and have paid a consolidated rent of ₹ 1.99 million in Fiscal 2022. Our Director, Gurdeep Soni is also a director of GCPL to whom the Company has granted a sub-lease pursuant to an agreement dated April 1, 2022. In addition, Gurdeep Soni is also a director of GCPL to whom the Company has granted a sub-lease pursuant to an agreement dated April 1, 2022. Further, except as stated in “*Financial Statements*” and “*Our Promoter and Promoter Group*” beginning on pages 212 and 206, respectively, and to the extent of their shareholding in our Company, as disclosed, our Directors do not have any other interest in our business.

#### **Interest in land and property**

None of our Directors have any interest in any property acquired or proposed to be acquired by our Company.

#### **Interest in promotion of our Company**

Except for Gurdeep Soni and Paramjit Singh Soni, none of our Directors have any interest in the promotion of our Company, as on the date of this Draft Red Herring Prospectus.

#### **Loans to Directors**

As of the date of this Draft Red Herring Prospectus, no loans have been availed by our Directors from our Company.

#### **Confirmations**

None of our Directors are and during the five years prior to the date of this Draft Red Herring Prospectus, have been on the board of any listed company whose shares have been/were suspended from being traded on BSE or NSE.

None of our Directors have been or are directors on the board of any listed companies which is or has been delisted from any stock exchange(s) during the term of their directorship in such companies.

### Changes in the Board in the last three years

The changes in our Board during the three years immediately preceding the date of this Draft Red Herring Prospectus are set forth below:

Name	Date of Change	Reason
Madhukar Rangnath Umarji	April 11, 2020	Resignation as Independent Director due to health issues
Ashish Kumar Agarwal	May 20, 2021	Resignation as Nominee Director
Harjit Singh Bhatia	May 21, 2021	Appointment as Nominee Director
Sanjeev Kumar Chanana	February 17, 2022	Appointment as Independent Director*
Paramjit Singh Soni	April 16, 2022	Redesignation as Executive Director and Vice Chairman**
Herbert Coenen	April 16, 2022	Redesignation as Non-Executive Director

\* Regularised pursuant to a resolution passed by the Shareholders on April 23, 2022.

\*\* Approved pursuant to a resolution passed by the Shareholders on April 23, 2022.

### Borrowing Powers of Board

Subject to the provisions of the Companies Act, our Articles of Association authorise our Board, at its discretion, to generally secure the payment of any sum or sums of money for the purposes of our Company. Pursuant to a resolution passed by the shareholders of our Company at the EGM held on April 23, 2022, our Board has been authorised to borrow any sum or sums of monies as and when required, from, including without limitation, any bank and/or other financial institution and/or foreign lender and/or any body corporate/ entity/entities and/or authority/authorities, either in rupees or in such other foreign currencies as may be permitted by law from time to time, as may be deemed appropriate by the Board for an aggregate amount not exceeding a sum of ₹ 7,500 million for the Company, and ₹ 15,000 million for the Company and its Subsidiaries taken together, notwithstanding that money so borrowed together with the monies already borrowed by the Company, if any (apart from temporary loans obtained from the Company's bankers in the ordinary course of business) may exceed the aggregate of the paid-up share capital of the Company and its free reserves.

### Corporate Governance

As on the date of this Draft Red Herring Prospectus, there are eight Directors on our Board comprising two Executive Directors, one Non-Executive Director, one Nominee Director and four Independent Directors. Further, we have one woman independent director on our Board. Our Board functions either as a full board or through various committees constituted to oversee specific functions. Our Company is in compliance with the corporate governance norms prescribed under the SEBI Listing Regulations and the Companies Act in relation to the composition of our Board and constitution of committees thereof. Our Company undertakes to take all necessary steps to continue to comply with all the applicable requirements of SEBI Listing Regulations and the Companies Act.

### Committees of the Board

Our Company has constituted the following committees of our Board in terms of the SEBI Listing Regulations and the Companies Act:

- (a) Audit Committee;
- (b) Nomination and Remuneration Committee;
- (c) Stakeholders' Relationship Committee;
- (d) Corporate Social Responsibility Committee; and
- (e) Risk Management Committee.

#### *Audit Committee*

The Audit Committee was last re-constituted by a resolution of the Board dated April 16, 2022. The Audit Committee is in compliance with Section 177 and other applicable provisions of the Companies Act and Regulation 18 of the SEBI Listing Regulations. The Audit Committee currently comprises of:

- (a) Sharat Krishan Mathur, Independent Director (Chairperson);

- (b) Alok Nagory, Independent Director (Member);
- (c) Harjit Singh Bhatia, Nominee Director (Member); and
- (d) Gurdeep Soni, Chairman and Managing Director (Member).

The Company Secretary shall act as the secretary to the Audit Committee.

*Scope and terms of reference:*

The Audit Committee shall have powers, including the following:

- (1) to investigate any activity within its terms of reference;
- (2) to seek information from any employee;
- (3) to obtain outside legal or other professional advice;
- (4) to secure attendance of outsiders with relevant expertise, if it considers necessary; and
- (5) such other powers as may be prescribed under the Companies Act, 2013 and the SEBI Listing Regulations.

The role of the Audit Committee shall include the following:

1. oversight of financial reporting process and the disclosure of financial information relating to Uniparts India Limited to ensure that the financial statements are correct, sufficient and credible;
2. recommendation to the board of directors of the Company for appointment, re-appointment, replacement, remuneration and terms of appointment of auditors of the Company and the fixation of the audit fee;
3. approval of payment to statutory auditors for any other services rendered by the statutory auditors of the Company;
4. reviewing, with the management, the annual financial statements and auditor's report thereon before submission to the Board for approval, with particular reference to:
  - a. Matters required to be included in the director's responsibility statement to be included in the Board's report in terms of clause (c) of sub-section 3 of section 134 of the Companies Act, 2013;
  - b. Changes, if any, in accounting policies and practices and reasons for the same;
  - c. Major accounting entries involving estimates based on the exercise of judgment by management;
  - d. Significant adjustments made in the financial statements arising out of audit findings;
  - e. Compliance with listing and other legal requirements relating to financial statements;
  - f. Disclosure of any related party transactions; and
  - g. Qualifications/Modified opinion(s) in the draft audit report.
5. reviewing, with the management, the quarterly, half-yearly and annual financial statements before submission to the Board for approval;
6. reviewing, with the management, the statement of uses / application of funds raised through an issue (public issue, rights issue, preferential issue, etc.), the statement of funds utilized for purposes other than those stated in the Offer document / prospectus / notice and the report submitted by the monitoring agency monitoring the utilization of proceeds of a public or rights issue, and making appropriate recommendations to the Board to take up steps in this matter;
7. reviewing and monitoring the auditor's independence and performance, and effectiveness of audit process;
8. approval of any subsequent modification of transactions of the Company with related parties and omnibus approval for related party transactions proposed to be entered into by the Company, subject to the conditions as may be prescribed by the independent directors who are members of the Audit Committee;

***Explanation:*** The term "related party transactions" shall have the same meaning as provided in Clause 2(zc) of the SEBI Listing Regulations and/or the applicable Accounting Standards and/or the Companies Act, 2013.

9. scrutiny of inter-corporate loans and investments;

10. valuation of undertakings or assets of the Company, wherever it is necessary;
11. evaluation of internal financial controls and risk management systems;
12. reviewing, with the management, performance of statutory and internal auditors, and adequacy of the internal control systems;
13. reviewing the adequacy of internal audit function, if any, including the structure of the internal audit department, staffing and seniority of the official heading the department, reporting structure coverage and frequency of internal audit;
14. discussion with internal auditors of any significant findings and follow-up thereon;
15. reviewing the findings of any internal investigations by the internal auditors into matters where there is suspected fraud or irregularity or a failure of internal control systems of a material nature and reporting the matter to the Board;
16. discussion with statutory auditors before the audit commences, about the nature and scope of audit as well as post-audit discussion to ascertain any area of concern;
17. looking into the reasons for substantial defaults in the payment to depositors, debenture holders, shareholders (in case of non-payment of declared dividends) and creditors;
18. reviewing the functioning of the whistle blower mechanism;
19. approval of appointment of chief financial officer after assessing the qualifications, experience and background, etc. of the candidate;
20. reviewing the utilization of loans and/or advances from/investment by the holding company in the subsidiary exceeding ₹1,000,000,000 or 10% of the asset size of the subsidiary, whichever is lower including existing loans/ advances/ investments existing as on the date of coming into force of this provision;
21. considering and commenting on rationale, cost-benefits and impact of schemes involving merger, demerger, amalgamation etc., on the listed entity and its shareholders; and
22. carrying out any other functions required to be carried out by the Audit Committee as may be decided by the Board and/or as provided under the Companies Act, 2013, the SEBI Listing Regulations or any other applicable law, as and when amended from time to time.”

The Audit Committee shall mandatorily review the following information:

1. Management discussion and analysis of financial condition and results of operations;
2. Statement of significant related party transactions (as defined by the Audit Committee), submitted by management;
3. Management letters / letters of internal control weaknesses issued by the statutory auditors;



4. Internal audit reports relating to internal control weaknesses;
5. The appointment, removal and terms of remuneration of the chief internal auditor shall be subject to review by the Audit Committee; and
6. Statement of deviations in terms of the SEBI Listing Regulations:
  - a. quarterly statement of deviation(s) including report of monitoring agency, if applicable, submitted to stock exchange(s) where the Equity Shares are proposed to be listed in terms of the SEBI Listing Regulations;
  - b. annual statement of funds utilized for purposes other than those stated in the offer document/ prospectus/ notice in terms of the SEBI Listing Regulations.

#### ***Nomination and Remuneration Committee***

The Nomination and Remuneration Committee was last re-constituted pursuant to a resolution passed by our Board on April 16, 2022. The composition and terms of reference of the Nomination and Remuneration Committee are in compliance with Section 178 and other applicable provisions of the Companies Act 2013 and Regulation 19 of the SEBI Listing Regulations. The Nomination and Remuneration Committee currently comprises of:

- (a) Alok Nagory, Independent Director (Chairperson);
- (b) Sharat Krishan Mathur, Independent Director (Member);
- (c) Harjit Singh Bhatia, Nominee Director (Member); and
- (d) Paramjit Singh Soni, Executive Director and Vice Chairman (Member).

#### *Scope and terms of reference:*

The role of the Nomination and Remuneration Committee shall include the following:

1. Formulation of the criteria for determining qualifications, positive attributes and independence of a director and recommend to the board of directors of the Company a policy relating to the remuneration of the directors, key managerial personnel and other employees ("**Remuneration Policy**");
2. For every appointment of an independent director, the Nomination and Remuneration Committee shall evaluate the balance of skills, knowledge and experience on the Board and on the basis of such evaluation, prepare a description of the role and capabilities required of an independent director. The person recommended to the Board for appointment as an independent director shall have the capabilities identified in such description. For the purpose of identifying suitable candidates, the Committee may (a) use the services of external agencies, if required; (b) consider candidates for a wide range of backgrounds, having due regard to diversity; and (c) consider the time commitments of the candidates;
3. Formulation of criteria for evaluation of performance of independent directors and the Board;
4. Devising a policy on diversity of the Board;
5. Identifying persons who are qualified to become directors and who may be appointed in senior management in accordance with the criteria laid down, and recommend to the Board their appointment and removal ;
6. Whether to extend or continue the term of appointment of the independent director, on the basis of the report of performance evaluation of independent directors;
7. Recommend to the Board, all remuneration, in whatever form, payable to senior management;
8. Carrying out any other functions required to be carried out by the Nomination and Remuneration Committee;
9. Performing such functions as are required to be performed by the Nomination and Remuneration Committee under the Securities and Exchange Board of India (Share Based Employee Benefits and Sweat

Equity) Regulations, 2021, as amended, including administering the existing and proposed employee stock option plans formulated by the Company from time to time (the “**Plan**”);

10. framing suitable policies, procedures and systems to ensure that there is no violation of securities laws, as amended from time to time, including:
  - (a) the Securities and Exchange Board of India (Prohibition of Insider Trading) Regulations, 2015; and
  - (b) the Securities and Exchange Board of India (Prohibition of Fraudulent and Unfair Trade Practices Relating to the Securities Market) Regulations, 2003, by the trust, the Company and its employees, as applicable.
  - (c) carrying out any other activities as may be delegated by the Board of Directors of the Company functions required to be carried out by the Nomination and Remuneration Committee as provided under the Companies Act, 2013, the SEBI Listing Regulations or any other applicable law, as and when amended from time to time.

### **Stakeholders’ Relationship Committee**

The Stakeholders’ Relationship Committee was last re-constituted by a resolution of our Board on April 16, 2022, in compliance with Section 178 and any other applicable law of the Companies Act 2013 and Regulation 20 of the SEBI Listing Regulations. The Stakeholders’ Relationship Committee currently comprises of:

- (a) Sharat Krishan Mathur, Independent Director (Chairperson);
- (b) Gurdeep Soni, Chairman and Managing Director (Member);
- (c) Sanjeev Kumar Chanana, Independent Director (Member); and
- (d) Harjit Singh Bhatia, Nominee Director (Member).

#### *Scope and terms of reference:*

The role of the Stakeholders’ Relationship Committee shall include the following:

1. Resolving the grievances of the security holders of the Company including complaints related to transfer/transmission of shares, non-receipt of annual report, non-receipt of declared dividends, issue of new/duplicate certificates, general meetings etc.;
2. Review of measures taken for effective exercise of voting rights by the shareholder;
3. Review of adherence to the service standards adopted by the Company in respect of various services being rendered by the Registrar & Share Transfer Agent;
4. Review of the various measures and initiatives taken by the Company for reducing the quantum of unclaimed dividends and ensuring timely receipt of dividend warrants/annual reports/statutory notices by the shareholders of the Company;
5. Formulation of procedures in line with the statutory guidelines to ensure speedy disposal of various requests received from shareholders from time to time;
6. Carrying out any other functions contained in the Companies Act, 2013 and/or equity listing agreements (if applicable), as and when amended from time to time; and

The quorum for any meeting of the Stakeholders’ Relationship Committee shall be two members.

### **Corporate Social Responsibility Committee**

The Corporate Social Responsibility Committee (“**CSR Committee**”) was constituted by a resolution of our Board dated April 4, 2014 and its composition and terms of reference are in compliance with Section 135 and other applicable provisions of the Companies Act 2013. The CSR Committee currently comprises of:

- (a) Gurdeep Soni, Chairman and Managing Director (Chairperson);

- (b) Paramjit Singh Soni, Vice-Chairman and Executive Director (Member); and
- (c) Sharat Krishan Mathur, Independent Director (Member).

*Scope and terms of reference:*

The role of the CSR Committee shall include the following:

1. Oversight of the development of the CSR vision, strategy, policies and plan
  - a. Recommend the Board the objective of Corporate Social Responsibility (CSR) to generate conducive environment to conduct the business in a socially responsible manner and to carry on business activities in the ethical way with regards to legal obligations and commitments;
  - b. Formulate and recommend to the Board, the corporate social responsibility policy (“**CSR Policy**”);
  - c. Monitor CSR Policy of the Company from time to time and recommend to the Board for modification(s) to the CSR Policy as and when required;
  - d. Formulation and recommendation to the Board an Annual Action Plan (AAP) in pursuance of the CSR Policy which shall include the items as specified in Rule 5(2) of the Companies (CSR Policy) Rules, 2014;
  - e. Recommend to the Board the amount of expenditure to be incurred on various activities in a financial year as per CSR policy and Annual Action Plan
2. Oversight of the implementation of the CSR vision and strategy
  - a. Establish steps for the effective implementation, maintenance, periodic reviews and improvement in CSR system in the Company;
  - b. Recommend to build CSR capacities of own personnel or of implementing agencies and to take measures to involve the employees in CSR activities of the Company;
  - c. Monitor the implementation of CSR programs undertaken by the Company;
  - d. Recommend the Board modalities and manner for transfer of ownership of capital assets, if created or acquired through CSR spending;
  - e. Develop and suggest the Board, Standard Operating Process (SoP) for manner of execution of any CSR projects and modalities for use of funds, factor risk assessment for any CSR project selected and plan for its management and control;
3. Oversight of the external communications policies
  - a. Oversee the publication, internally and externally, of corporate responsibility performance and plans using the Company’s website, annual report and other such methods of communication as are considered necessary;
  - b. Suggest agencies to have Need Assessment and Impact Assessment of any CSR project of the Company for monitoring the quality and efficacy of CSR projects of the Company;
  - c. Communicating commitments, performances, reports, and other information in timely and legal manner and review the quality of any reporting to external stakeholders concerning CSR matters (to form part of the Annual Report)
4. Other responsibility
  - a. Any other matter as may be considered expedient in furtherance of and to comply with the CSR Policy and CSR activities of the Company;
  - b. In carrying out its responsibilities, the Committee shall work and liaise as necessary with all other Board committees, and give due consideration to all relevant laws, rules, regulations and regulatory requirements and guidance applicable to the Company.

The quorum for any meeting of the Corporate Social Responsibility Committee shall be two members.

### ***Risk Management Committee***

The Risk Management Committee was constituted by a resolution of our Board dated April 16, 2022. The scope and functions of the Risk Management Committee are in compliance with the Regulation 21 of the SEBI Listing Regulations. The Risk Management Committee currently comprises of:

- (a) Herbert Coenen, Non-Executive Director (Chairperson);
- (b) Gurdeep Soni, Chairman and Managing Director (Member);
- (c) Sharat Krishan Mathur, Independent Director (Member).
- (d) Sudhakar S Kolli, Group Chief Operating Officer (Member); and
- (e) Munish Sapra, Group Chief Financial Officer (Member).

#### *Scope and terms of reference:*

The role of the Risk Management Committee shall include the following:

1. Formulation of a detailed risk management policy which shall include: (a) a framework for identification of internal and external risks specifically faced by the Company, in particular including financial, operational, sectoral, sustainability (particularly, ESG related risks), information, cyber security risks or any other risk as may be determined by the Risk Management Committee; (b) measures for risk mitigation including systems and processes for internal control of identified risks; and (c) business continuity plan;
2. Ensure that appropriate methodology, processes and systems are in place to monitor and evaluate risks associated with the business of the Company;
3. Monitor and oversee implementation of the risk management policy, including evaluating the adequacy of risk management systems;
4. Periodically review the risk management policy, at least once in two years, including by considering the changing industry dynamics and evolving complexity;
5. Keep the Board of Directors of the Company informed about the nature and content of its discussions, recommendations and actions to be taken; and
6. Review the appointment, removal and terms of remuneration of the Chief Risk Officer (if any)
7. Coordinate its activities with other committees, in instances where there is any overlap with activities as per the framework laid down by the Board of Directors;
8. Any other similar or other functions as may be laid down by Board from time to time and/or as may be required under applicable law, as and when amended from time to time.

Further, we have also constituted an IPO Committee and certain internal committees for the internal management of our Company.

**Management Organisation Chart**

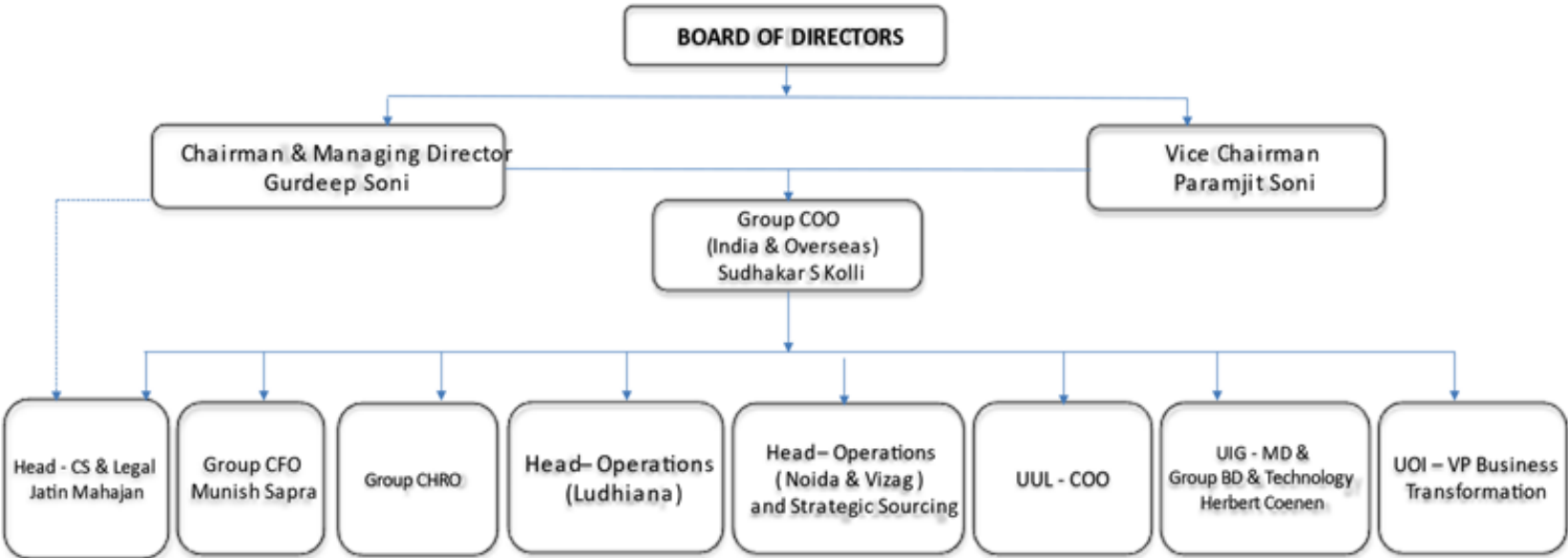

## **Key Managerial Personnel**

The details of the Key Managerial Personnel, in terms of the Companies Act, as of the date of this Draft Red Herring Prospectus are as follows:

In addition to Gurdeep Soni, Paramjit Singh Soni and Herbert Coenen, whose details are provided above in “–*Brief Profiles of our Directors*” on page 191, the details of our other Key Managerial Personnel as on the date of this Draft Red Herring Prospectus are set forth below.

**Sudhakar S Kolli** is the Group Chief Operating Officer of our Company. He holds a bachelor’s degree in mechanical engineering from Andhra University and a master’s degree in mechanical engineering from University of Bridgeport University, USA. He also holds a master’s degree in business administration from Millikin University, USA. He has 25 years of experience in the areas including general management with leadership role, operations and product development. Previously, he worked with Joy Technologies Inc., Joy Mining Machinery, CNH Industrial America LLC and Hyva Holding Limited and spent over 13 years with Caterpillar Inc. He joined our Company on February 8, 2016. He is responsible for strategic planning, business development and growth, management and organization building, reputation and brand building, operations, people management and other assignments or initiatives as mandated by our Board for improvement of our business performance. During Fiscal 2022, he received a remuneration of ₹ 23.11 million.

**Munish Sapra** is the Group Chief Financial Officer of our Company. He holds a bachelor’s degree in commerce from Maharshi Dayanand University and a diploma in financial management from Indira Gandhi National Open University. He is a qualified chartered accountant and has completed the country focused training course in Opportunity A for Visionary Leaders for Manufacturing organized by the Japan International Cooperation Agency. He has also participated in ISO 14001 internal EMS audit training programme held at Sona Okegawa Precision Forging Limited. He has over 27 years of experience in the fields of finance and accounts. He has previously worked with Sona BLW Precision Forgings Limited, Sunbeam Castings and Bharti Healthcare Limited. He is responsible for group financial planning, budgeting, cost accounting, audits, direct and indirect taxes and management of financial risk exposure. During Fiscal 2022, he received a remuneration of ₹ 13.51 million.

**Jatin Mahajan** is the Company Secretary and Compliance Officer and Head – Legal and Secretarial of our Company. He holds a bachelor’s degree in law from Chaudhary Charan Singh University, Meerut and a master’s degree in business administration from Annamalai University. He is also a fellow member of the Institute of Company Secretaries of India. He has over 16 years of experience in secretarial, legal and finance functions. He has previously worked with BPTP Limited, DEN Networks Limited and Devyani International Limited. During Fiscal 2022, he received a remuneration of ₹ 0.26 million.

### **Contingent or deferred compensation**

No contingent or deferred compensation was paid to any of our Key Managerial Personnel for Fiscal 2022.

### **Status of Key Managerial Personnel**

Except Gurdeep Soni, Paramjit Singh Soni and Herbert Coenen who are employees of our Subsidiaries, GFPL, UUL and UIG, respectively, all the Key Managerial Personnel are permanent employees of our Company.

### **Relationship amongst Key Managerial Personnel**

Except for Gurdeep Soni and Paramjit Singh Soni who are brothers, none of the Key Managerial Personnel are related to each other or to the Directors of our Company.

### **Arrangement or understanding with major shareholders, customers, suppliers or others**

None of our Key Managerial Personnel have been selected pursuant to any arrangement or understanding with any major shareholders, customers or suppliers of our Company, or others.

### **Bonus or profit sharing plan for the Key Managerial Personnel**

Except for Gurdeep Soni, Paramjit Singh Soni and Herbert Coenen, our Key Managerial Personnel are paid performance linked incentive pay based on the performance management policy of our Company dated April 1, 2020. Under this policy which is applicable to our Key Managerial Personnel, along with other employees of the

Uniparts Group, the appraisal process covers three tier evaluation process consisting of (i) certain key performance indicators; (ii) self-appraisal; and (iii) performance review and rating. Except as stated above, our Company does not have bonus or profit sharing plan for the Key Managerial Personnel.

### Shareholding of Key Managerial Personnel

Other than as provided under “*Capital Structure – Shareholding of Directors and Key Managerial Personnel*” on page 96, none of our Key Managerial Personnel hold Equity Shares as on the date of this Draft Red Herring Prospectus.

### Service Contracts with Key Managerial Personnel

Except for Herbert Coenen, who is entitled to statutory benefits and non-compete fee upon termination of his employment from our Subsidiary, UIG, and our Executive Directors, who are also entitled to statutory benefits upon termination of their employment from the relevant Subsidiaries, none of the Key Managerial Personnel of our Company have entered into a service contract with our Company, pursuant to which they are entitled to any benefits upon termination of employment. For further details, see “- *Remuneration to Executive Directors*” on page 192 and “- *Remuneration paid or payable to our Directors from our Subsidiaries*” on page 193.

### Interest of Key Managerial Personnel

Other than as provided in “- *Interest of Directors*” above on page 195 and to the extent of the remuneration, benefits, interest of receiving dividends on the Equity Shares held by them, if any, reimbursement of expenses incurred in the ordinary course of business, our Key Managerial Personnel may be interested to the extent of employee stock options that may be granted to them from time to time under ESOP 2007 and other employee stock option schemes formulated by our Company from time to time.

### Employee stock option schemes

For details of ESOP 2007 implemented by our Company, see “*Capital Structure – Employee Stock Option Schemes of our Company*” on page 99.

### Changes in Key Managerial Personnel during the last three years

The changes in our Key Managerial Personnel during the three years immediately preceding the date of this Draft Red Herring Prospectus are set forth below.

Name	Date of change	Reason
Jatin Mahajan	March 22, 2022	Appointment as Company Secretary and Compliance Officer and Head – Legal and Secretarial
Ashish Kumar Srivastava	January 18, 2022	Resignation as Company Secretary and General Manager-Legal
Ashish Kumar Srivastava	July 27, 2021	Appointment as Company Secretary and General Manager-Legal
Mukesh Kumar	February 11, 2021	Resignation as Company Secretary
Rini Kalra	March 31, 2020	Superannuation
Munish Sapra	May 28, 2019	Appointment as Chief Financial Officer*
Sanjiv Kashyap	May 27, 2019	Resignation as Chief Financial Officer

\* *Munish Sapra was appointed as the group chief financial officer of the Company since January 7, 2019 and pursuant to a board resolution dated May 20, 2019 he was also designated as Chief Financial Officer with effect from May 28, 2019.*

### Payment or benefit to Key Managerial Personnel of our Company

No amount or benefit has been paid or given to any officer of our Company within the two years preceding the date of filing of this Draft Red Herring Prospectus or is intended to be paid or given, other than in the ordinary course of their employment

## PROMOTER AND PROMOTER GROUP

### Our Promoters

The Promoters of our Company are:

1. Gurdeep Soni; and
2. Paramjit Singh Soni

As on the date of this Draft Red Herring Prospectus, our Promoters hold 9,195,090 Equity Shares in aggregate, representing 20.37% of the issued, subscribed and paid-up Equity Share capital of our Company.

For details on shareholding of our Promoters in our Company, see “*Capital Structure – Notes to Capital Structure*” on page 87.

### Details of our Promoters

---



#### Gurdeep Soni

Gurdeep Soni, born on March 18, 1955, aged 67 years, is our Chairman and Managing Director. He is a resident of 142, Church Road, Avenue-7 Vasant Kunj, South West Delhi, Delhi 110 070, India. As on the date of this Draft Red Herring Prospectus, Gurdeep Soni holds 8,995,090 Equity Shares representing 19.93% of the issued, subscribed and paid-up Equity Share capital of our Company. For the complete profile of Gurdeep Soni along with the details of his educational qualification, experience in the business/employment, positions/posts held in past, directorship, special achievements, his business and financial activities, see “*Our Management*” on page 189.

The permanent account number of Gurdeep Soni is AAUPS8519C.

Other than as disclosed in “*Our Management*” on page 189, Gurdeep Soni is not involved in any other venture.

---



#### Paramjit Singh Soni

Paramjit Singh Soni, born on October 9, 1960, aged 61 years, is our Executive Director and Vice Chairman. He is a US citizen and is a resident of 596, High Hampton, Dr. Martinez, GA 30907 - 9183, USA. As on the date of this Draft Red Herring Prospectus, Paramjit Singh Soni holds 200,000 Equity Shares representing 0.44% of the issued, subscribed and paid-up Equity Share capital of our Company. For the complete profile of Paramjit Singh Soni along with the details of his educational qualification, experience in the business/employment, positions/posts held in past, directorship, special achievements, his business and financial activities, see “*Our Management*” on page 189.

The permanent account number of Paramjit Singh Soni is ABAPS1632H.

Other than as disclosed in “*Our Management*” on page 189, Paramjit Singh Soni is not involved in any other venture.

---

Our Company confirms that the permanent account number, bank account number(s), passport number, aadhar card number and driving license number of our Promoters will be submitted to the Stock Exchanges at the time of filing of this Draft Red Herring Prospectus.

### Change in the control of our Company

Our Promoters are the original promoters of our Company and there has not been any change in the control of our



Company in the five years immediately preceding the date of this Draft Red Herring Prospectus.

### **Interests of Promoters**

Our Promoters are interested in our Company to the extent that they have promoted our Company and to the extent of their respective shareholding in our Company, their directorship in our Company and the dividends payable, if any, and any other distributions in respect of their respective shareholding in our Company or the shareholding of their relatives in our Company. For details of the shareholding of our Promoters in our Company, see “*Capital Structure*” beginning on page 87. For further details of interest of our Promoters in our Company, see “*Our Management*”, “*Financial Statements - Related Party Disclosure*” and “*Financial Statements*” on pages 189, 306 and 212 respectively.

Our Promoters may be deemed to be interested to the extent of remuneration, benefits and reimbursement of expenses payable to them as the Directors of our Company and our Subsidiaries. For further details, see “*Our Management*” beginning on page 189.

Except for Gurdeep Soni and Paramjit Singh Soni who are Promoters and Directors of our Company, none of our Directors have any interest in the promotion of our Company.

Our Promoters and Directors have no interest in any property acquired by our Company during the three years preceding the date of this Draft Red Herring Prospectus, or proposed to be acquired, or in any transaction by our Company for acquisition of land, construction of building or supply of machinery.

Except to the extent of their directorship and shareholding in our Subsidiaries, our Promoters do not have any interest in any venture that is involved in any activities similar to those conducted by our Company. For further details, see “*Our Management*” beginning on page 189 and “*History and Certain Corporate Matters*” beginning on page 180.

Our Promoters are not interested as a member in any firm or company which has any interest in our Company. Further, no sum has been paid or agreed to be paid to any of our Promoters or to any firm or company in which any of our Promoters are interested as a member, in cash or shares or otherwise by any person either to induce any of our Promoters to become, or qualify them as a director, or otherwise for services rendered by any of our Promoters or by such firm or company in connection with the promotion or formation of our Company.

### **Payments or benefits to our Promoters or Promoter Group**

Except as disclosed in this section and stated otherwise in “*Financial Statements - Related Party Disclosure*” and “*Financial Statements*” beginning on pages 306 and 212 respectively about the related party transactions entered into during the last three Fiscals and in “*Our Management*” beginning on page 189, there has been no payment or benefit to our Promoters or Promoter Group during the two years prior to the filing of this Draft Red Herring Prospectus nor is there any intention to pay or give any benefit to our Promoters or members of the Promoter Group as on the date of this Draft Red Herring Prospectus.

The Registered Office of the Company is leased from a member of our Promoter Group, Soni Holdings (Partnership Firm). Our Director, Gurdeep Soni is interested in the lease agreement by virtue of him being a partner in Soni Holdings (Partnership Firm). In addition, Gurdeep Soni is also a director of GCPL to whom the Company has granted a sub-lease pursuant to an agreement dated April 1, 2022. For further details, see “*Our Management – Interest of Directors*” on page 195.

### **Confirmations**

Our Promoters and members of our Promoter Group have not been prohibited from accessing or operating in capital markets or restrained from buying, selling or dealing in securities under any order or direction passed by SEBI or any other regulatory or governmental authority.

Our Promoters are not and have never been a promoter, director or person in control of any other company which is prohibited from accessing or operating in capital markets under any order or direction passed by SEBI.

None of the companies our Promoters are associated with or companies promoted by any of them, have been delisted or suspended in the past.

Our Promoters have not been identified as Wilful Defaulters nor as Fraudulent Borrowers as defined under the SEBI ICDR Regulations.

Our Promoters have not been declared fugitive economic offenders under section 12 of the Fugitive Economic Offenders Act, 2018, as amended.

### Companies or firms with which our Promoters have disassociated in the last three years

Except as mentioned below, our Promoters have not disassociated themselves from any company in the three years immediately preceding the date of this Draft Red Herring Prospectus.

S. No	Name of the company	Promoter associated	Date of disassociation	Reason for disassociation
1.	Uniparts Engineering Private Limited	Gurdeep Soni	February 21, 2022	Entity has been struck off
2.	Vivify Net Private Limited	Gurdeep Soni	February 21, 2022	Entity has been struck off
3.	Sweaty Spirit Apparel Limited	Paramjit Singh Soni	May 10, 2021	Resigned as director
4.	Avid Maintenance Private Limited	Paramjit Singh Soni	July 19, 2018	Avid Maintenance Private Limited was converted to Avid Maintenance LLP

### Material Guarantees to third parties with respect to the Equity Shares

Our Promoters have not given any material guarantee to any third party with respect to the Equity Shares as on the date of this Draft Red Herring Prospectus.

### Promoter Group

In addition to our Promoters, the individuals and entities that form a part of the Promoter Group of our Company in terms of Regulation 2(1)(pp) of the SEBI ICDR Regulations are set out below:

### Natural persons who are part of the Promoter Group

The natural persons who are part of the Promoter Group (due to their relationship with our Promoters), other than our Promoters, are as follows:

Name of Promoter	Name of relative	Relationship
Gurdeep Soni	Pamela Soni	Spouse
	Arjun Soni	Son
	Angad Soni	Son
	Tanya Kohli	Daughter
	Paramjit Singh Soni	Brother
	Sonu Kapoor	Sister
	Harminder Chatha	Spouse's mother
	Neela Goolry	Spouse's sister
Paramjit Singh Soni	Sarabjit Soni	Spouse
	Karan Soni	Son
	Meher Soni	Daughter
	Gurdeep Soni	Brother
	Sonu Kapoor	Sister
	Santosh Kaur	Spouse's mother
	Jaswinder Singh Bhogal	Spouse's brother

*\*Our Company, pursuant to a letter dated April 25, 2022 has sought an exemption from the inclusion of Navjit Bindra, sister of the spouse of our Promoter, Paramjit Singh Soni, from inclusion in the "Promoter Group" on account of not receiving any information from Navjit Bindra and entities she may be interested in for inclusion in this Draft Red Herring Prospectus.*

### Entities forming part of the Promoter Group

The entities forming part of our Promoter Group are as follows:

1. Amazing Estates Private Limited;
2. Avid Maintenance LLP;
3. Bluebells Homes Private Limited;

4. Charisma Homes LLP;
5. Farmparts Company (Partnership Firm);
6. Gifting Trust of Karan Soni;
7. Gifting Trust of Meher Soni;
8. G.K.P. Farms Private Limited;
9. Gripwel Fasteners (Partnership Firm);
10. Gurdeep Soni (HUF);
11. Indento International (Partnership Firm);
12. Leon India (Partnership Firm);
13. Ninety Hospitality LLP
14. Paper Bag Entertainment Inc.;
15. Paramjit Soni (HUF);
16. Paramjit Soni Gifting Trust;
17. P. Soni Family Trust;
18. Sarabjit Soni Gifting Trust;
19. Sepoy Beverages LLP;
20. Sepoy Drinks Private Limited;
21. SGA Trading Private Limited;
22. Silveroak Estates Private Limited;
23. SKG Engineering Private Limited;
24. Soni Foundation;
25. Soni Family Foundation INC;
26. Soni Holdings (Partnership Firm);
27. Sweaty Spirit Apparel Limited;
28. The Karan Soni 2018 CG-NG Nevada Trust;
29. The Meher Soni 2018 CG-NG Nevada Trust;
30. The Paramjit Soni 2018 CG-NG Nevada Trust;
31. Tima Trading Private Limited; and
32. 7 Days Film LLC.

## **OUR GROUP COMPANIES**

As per the SEBI ICDR Regulations, for the purpose of identification of group companies, our Company has considered (i) such companies (other than corporate promoters, if any, and any direct and indirect subsidiaries) with which there were related party transactions, during the period for which financial information is disclosed in this Draft Red Herring Prospectus, as covered under Ind AS 24; (ii) the companies which are members of the Promoter Group in terms of Regulation 2(1)(pp) of the SEBI ICDR Regulations and with which there were related party transactions in the most recent fiscal for which financial information is disclosed in this Draft Red Herring Prospectus, as covered under Ind AS 24, which, individually or in the aggregate, exceed 10% of the total restated consolidated revenues of the Company for such Fiscal; (iii) related parties with which there were transactions for the period (after the stub period) in respect of which, the financial information is disclosed in this Draft Red Herring Prospectus; and (iv) any other companies as may be identified as material by the Board.

Based on the above, our Company does not have any group company as on the date of this Draft Red Herring Prospectus.

## DIVIDEND POLICY

The declaration and payment of dividends, if any, will be recommended by our Board and approved by our Shareholders, at their discretion, subject to the provisions of our Articles of Association and the applicable law, including the Companies Act. The quantum of dividend, if any, will depend on a number of factors, including but not limited to the earnings, capital requirements, contractual obligations, applicable legal restrictions and overall financial position of our Company.

Any future determination as to the declaration of and payment of dividend will be based on the recommendation of our Board, and will depend on a number of factors, including but not limited to the earnings, past dividend trends, capital requirements, contractual obligations, applicable legal restrictions, overall financial position of our Company and other factors considered relevant by our Board. In addition, our ability to pay dividends may be impacted by a number of other factors, including restrictive covenants under the loan or financing documents, our Company is currently a party to or may enter into from time to time. Pursuant to the dividend policy, while the Board is required to endeavour to maintain an annual dividend pay-out of 25% of consolidated profit as dividend, it has the discretion to deviate from the pay-out percentage in consideration of all relevant factors as laid down in the dividend policy.

For more information on restrictive covenants under our loan agreements, see “*Financial Indebtedness*” beginning on page 352.

The dividend paid on the Equity Shares by our Company is set out in the following table:

Particulars	Fiscal 2019	Fiscal 2020	Fiscal 2021	From April 1, 2021 to December 31, 2021	From January 1, 2022 until the date of this DRHP
Face value per share (in ₹)	10	10	10	10	10
Dividend (in ₹ million)	54.16	-	148.94	-	252.75
Dividend per share (in ₹)	1.20	-	3.30	-	5.60
Rate of dividend (%)	12	-	33	-	56
Dividend Tax (%)	20.19	-	-	-	-
No. of Equity Shares	45,133,758	45,133,758	45,133,758	45,133,758	45,133,758
Dividend Tax (in ₹ million)	11.13	-	-	-	-
Mode of Payment	NEFT/RTGS/TT	NA	NEFT/RTGS/TT	NA	NEFT/RTGS/TT

The amounts paid as dividends in the past are not necessarily indicative of the dividend distribution policy of our Company or dividend amounts, if any, in the future. Investors are cautioned not to rely on past dividends as an indication of the future performance of our Company or for an investment in the Equity Shares offered in the Issue. There is no guarantee that any dividends will be declared or paid or that the amount thereof will not be decreased in the future. For more details, please see “*Risk Factors – Our Company may not be able to pay dividends in the future. Our ability to pay dividends in the future will de-pend on our earnings, financial condition, working capital requirements, capital expenditures and re-strictive covenants of our financing arrangements*” on page 55.

## SECTION V – FINANCIAL STATEMENTS

### RESTATED FINANCIAL STATEMENTS

**Independent Auditors’ Examination Report on the Restated Consolidated Summary Statement of Assets and Liabilities as at December 31, 2021, March 31, 2021, March 31, 2020 and March 31, 2019, and the Restated Consolidated Summary Statement of Profits and Losses (including Other Comprehensive Income) and Restated Consolidated Summary Statement of Cash Flows and Restated Consolidated Summary Statement of Changes in Equity for the nine months period ended December 31, 2021 and for each of the years ended March 31, 2021, March 31, 2020 and March 31, 2019, the Consolidated Summary Statement of Significant Accounting Policies, Notes and Other Explanatory Information of Uniparts India Limited (collectively, the “Restated Consolidated Summary Statements”)**

To,  
The Board of Directors  
Uniparts India Limited  
Gripwel House,  
Block – 5, C-6&7,  
Vasant Kunj,  
New Delhi – 110070.

Dear Sirs / Madams,

1. We, Rakesh Banwari & Co., have examined the attached Restated Consolidated Financial Information of **Uniparts India Limited** (the ‘**Company**’ or ‘**Issuer**’) and its subsidiaries (the Company and its subsidiaries together referred to as the ‘**Group**’), comprising the Restated Consolidated Statement of Assets and Liabilities as at December 31, 2021, the Restated Consolidated Statement of Profit and Loss (including other comprehensive income), the Restated Consolidated Statement of Changes in Equity and the Restated Consolidated Statement of Cash Flow for the nine-months period ended December 31, 2021 and Restated Consolidated Statement of Assets and Liabilities as at March 31, 2021, March 31, 2020 and March 31, 2019, the Restated Consolidated Statement of Profit and Loss (including other comprehensive income), the Restated Consolidated Statement of Changes in Equity and the Restated Consolidated Statement of Cash Flows for the years ended March 31, 2021, March 31, 2020 and March 31, 2019 and the Summary Statement of Significant Accounting Policies, and other explanatory information (collectively, the ‘**Restated Consolidated Financial Information**’), as approved by the Board of Directors of the Company at their meeting held on March 22, 2022 for the purpose of inclusion in the Draft Red Herring Prospectus (‘**DRHP**’) prepared by the Company in connection with its proposed Initial Public Offer of equity shares (‘**IPO**’) prepared in terms of the requirements of:
  - a. Section 26 of Part I of Chapter III of the Companies Act, 2013 (the ‘**Act**’);
  - b. The Securities and Exchange Board of India (Issue of Capital and Disclosure Requirements) Regulations, 2018, as amended (‘**SEBI ICDR Regulations**’); and
  - c. The Guidance Note on Reports in Company Prospectuses (Revised 2019) issued by the Institute of Chartered Accountants of India (‘**ICAI**’), as amended from time to time (the ‘**Guidance Note**’).
2. The Company’s Board of Directors is responsible for the preparation of the Restated Consolidated Financial Information for the purpose of inclusion in the DRHP to be filed with Securities and Exchange Board of India (‘**SEBI**’), National Stock Exchange of India Limited and BSE Limited (collectively, the ‘**Stock Exchanges**’) in connection with the proposed IPO. The Restated Consolidated Financial Information have been prepared by the management of the Company on the basis of preparation stated in note 2 to the Restated Consolidated Financial Information. The responsibility of the respective Board of Directors of the companies included in the Group includes designing, implementing and maintaining adequate internal control relevant to the preparation and presentation of the Restated Consolidated Financial Information. The respective Board of Directors are also responsible for identifying and ensuring that the Group complies with the Act, SEBI ICDR Regulations and the Guidance Note.
3. We have examined such Restated Consolidated Financial Information taking into consideration:

- a. The terms of reference and terms of our engagement agreed upon with you in accordance with our engagement letter dated January 11, 2022 in connection with the proposed IPO of equity shares of the Issuer;
  - b. The Guidance Note. The Guidance Note also requires that we comply with the ethical requirements of the Code of Ethics issued by the ICAI;
  - c. Concepts of test checks and materiality to obtain reasonable assurance based on verification of evidence supporting the Restated Consolidated Financial Information; and
  - d. The requirements of section 26 of the Act and the SEBI ICDR Regulations. Our work was performed solely to assist you in meeting your responsibilities in relation to your compliance with the Act, the SEBI ICDR Regulations and the Guidance Note in connection with the IPO.
4. These Restated Consolidated Financial Information have been compiled by the management from:
- a. Audited special purpose interim consolidated financial statements of the Group as at and for the nine-months period ended December 31, 2021 prepared in accordance with Ind AS 34 ‘Interim Financial Reporting’, specified under section 133 of the Act and other accounting principles generally accepted in India (the ‘**Special Purpose Interim Consolidated Financial Statements**’) which have been approved by the Board of Directors at their meeting held on March 22, 2022.
  - b. Audited financial statements of the Company as at and for the years ended March 31, 2021, March 31, 2020 and March 31, 2019 prepared in accordance with the Ind AS as prescribed under section 133 of the Act read with Companies (Indian Accounting Standards) Rules 2015, as amended, and other accounting principles generally accepted in India, which have been approved by the Board of Directors at their meetings held on July 27, 2021, August 29, 2020 and May 20, 2019, respectively.
5. For the purpose of our examination, we have relied on:
- a. Auditors’ reports issued by us dated March 22, 2022, July 27, 2021, August 29, 2020 and May 20, 2019, on the special purpose interim consolidated financial statements of the Group as at and for the nine - months period ended December 31, 2021 and the financial statements of the Company as at and for the year ended 31 March 2021, March 31, 2020 and March 31, 2019 respectively as referred in Paragraph 4 above.
6. As indicated in our audit report referred above:
- a. We did not audit the financial statements of subsidiaries/ step-down subsidiaries Uniparts USA Ltd., Uniparts Olsen Inc., Uniparts Europe B.V., Uniparts India GmbH, Gripwel Fasteners Private Limited as at December 31, 2021, March 31, 2021, March 31, 2020 and March 31, 2019, whose aggregate share of total assets, total revenues, and net cash flows and subsidiaries share of net profit/loss, included in the Restated Consolidated Financial Information, for the relevant years is tabulated below:

(Rs. in Millions)

Particulars	December 31, 2021	March 31, 2021	March 31, 2020	March 31, 2019
Total Assets*	6096.17	5209.95	5730.28	5293.43
Revenue*	6476.52	6679.68	6987.72	8281.83
Net Cash Inflows*	37.80	(71.17)	73.87	(22.19)
Group’s share of net profit/ loss*	618.59	531.46	469.51	424.57

\*Gross before giving consolidation adjustments

These financial statements have been audited by other audit firms, as set out in Appendix-1, whose reports have been furnished to us by the Company and our opinion in so far as it relates to the amounts included in these Restated Consolidated Financial Information are based solely on the report of other auditors.

Our opinion on the consolidated Ind AS financial statements is not modified in respect of these matters

7. Based on our examination and according to the information and explanations given to us and also as per the reliance placed on the examination report submitted by the Previous Auditors for the respective years and as per the reliance placed on the examination report submitted by the other auditors for the subsidiaries and step-down subsidiary included in the Group for the period ended December 31, 2021, we report that the Restated Consolidated Financial Information:
- a. have been prepared after incorporating adjustments for the changes in accounting policies, material errors and regrouping / reclassifications retrospectively in the financial years ended March 31, 2021, March 31, 2020 and March 31, 2019 to reflect the same accounting treatment as per the accounting policies and grouping / classifications followed as at and for the nine-months period ended December 31, 2021
  - b. have been prepared in accordance with the Act, SEBI ICDR Regulations and the Guidance Note.
8. The Restated Consolidated Financial Information do not reflect the effects of events that occurred subsequent to the respective dates of the reports on the special purpose interim consolidated financial statements and audited financial statements mentioned in paragraph 4 above.
9. This report should not in any way be construed as a reissuance or re-dating of any of the previous audit reports issued by us or the Previous Auditors, nor should this report be construed as a new opinion on any of the financial statements referred to herein.
10. We have no responsibility to update our report for events and circumstances occurring after the date of the report.
11. Our report is intended solely for use of the Board of Directors for inclusion in the DRHP to be filed with SEBI and the Stock Exchanges, in connection with the proposed IPO. Our report should not be used, referred to, or distributed for any other purpose except with our prior consent in writing. Accordingly, we do not accept or assume any liability or any duty of care for any other purpose or to any other person to whom this report is shown or into whose hands it may come without our prior consent in writing.

For Rakesh Banwari & Co.  
Chartered Accountants  
Firm Registration No: 009732N

(Rakesh Aggarwal)  
Proprietor  
Membership Number: 088193  
UDIN: 22088193AGNENE9941  
Place: New Delhi  
Date: 22 March 2022



**Appendix-1 attached to our examination report dated 22 March 2022 on Restated Consolidated Financial Information of Uniparts India Limited**

<b>Sl. No.</b>	<b>Name of Subsidiary / Step down subsidiary</b>	<b>Name of the auditor for the nine months ended December 31, 2021</b>	<b>Name of the auditor for the financial year ended March 31, 2021</b>	<b>Name of the auditor for the financial year ended March 31, 2020</b>	<b>Name of the auditor for the financial year ended March 31, 2019</b>
1.	Uniparts USA Ltd	KNAV P.A.	KNAV P.A.	KNAV P.A.	Withum Smith+Brown, PC
2.	Uniparts Olsen Inc.	KNAV P.A.	KNAV P.A.	KNAV P.A.	Withum Smith+Brown, PC
3.	Uniparts Europe B. V.	Kroese Wevers Audit BV	Kroese Wevers Audit BV	Kroese Wevers Audit BV	Kroese Wevers Audit BV
4.	Uniparts India GmbH	dhpg Dr. Harzem & Partner mbB	dhpg Dr. Harzem & Partner mbB	dhpg Dr. Harzem & Partner mbB	dhpg Dr. Harzem & Partner mbB
5.	Gripwel Fasteners Private Limited	S. C Varma and Co., Chartered Accountants	S. C Varma and Co., Chartered Accountants	S. C Varma and Co., Chartered Accountants	S. C Varma and Co., Chartered Accountants

**Uniparts India Limited**  
**Annexure I - Restated Consolidated Statement of Assets and Liabilities**  
**(All amounts are in Rs. million, unless stated otherwise)**

	Particulars	Annexure V Note	As at 31st December 2021	As at 31st March 2021	As at 31st March 2020	As at 31st March 2019
<b>I</b>	<b>ASSETS</b>					
	<b>NON-CURRENT ASSETS</b>					
	Property, plant and equipment	3(a)	2,013.68	2,001.91	2,069.96	2,179.84
	Right of use assets	3(b)	529.23	578.00	662.40	749.18
	Capital work-in-progress	3(c)	57.51	22.87	93.21	58.75
	Goodwill		612.30	590.01	597.87	601.66
	Other intangible assets	3(d)	39.85	54.23	68.26	24.33
	Intangible assets under development	3(e)	-	-	6.30	30.02
	Financial assets					
	Other financial assets	4	46.24	44.49	50.48	51.40
	Current tax assets (Net) - non current		68.60	112.84	112.27	126.51
	Other non-current assets	5	18.50	22.32	4.46	27.46
	<b>Total non-current assets</b>		<b>3,385.91</b>	<b>3,426.67</b>	<b>3,665.21</b>	<b>3,849.15</b>
	<b>CURRENT ASSETS</b>					
	Inventories	6	4,545.71	3,390.79	3,529.17	3,674.66
	Financial assets					
	Investments	7	17.58	12.50	-	-
	Trade receivables	8	1,613.74	1,675.32	1,228.35	1,453.58
	Cash and cash equivalents	9	131.73	108.18	169.21	78.51
	Other balances with banks	9	-	-	0.35	72.42
	Derivative instruments		45.44	35.38	-	14.70
	Loans	10	3.77	3.44	1.70	4.90
	Other financial assets	4	0.32	0.33	0.33	0.40
	Other current assets	5	328.33	280.09	393.15	436.05
	<b>Total current assets</b>		<b>6,686.62</b>	<b>5,506.03</b>	<b>5,322.26</b>	<b>5,735.22</b>
	<b>TOTAL ASSETS</b>		<b>10,072.53</b>	<b>8,932.70</b>	<b>8,987.47</b>	<b>9,584.37</b>

**Uniparts India Limited**  
**Annexure I - Restated Consolidated Statement of Assets and Liabilities**  
(All amounts are in Rs. million, unless stated otherwise)

	Particulars	Annexure V Note	As at 31st December 2021	As at 31st March 2021	As at 31st March 2020	As at 31st March 2019
<b>II</b>	<b>EQUITY AND LIABILITIES</b>					
	<b>EQUITY</b>					
	Equity share capital	11	446.20	446.20	446.20	446.20
	Other equity	12	6,213.42	5,147.61	4,195.45	3,773.61
	<b>Total equity</b>		<b>6,659.62</b>	<b>5,593.81</b>	<b>4,641.65</b>	<b>4,219.81</b>
	<b>LIABILITIES</b>					
	<b>NON-CURRENT LIABILITIES</b>					
	Financial liabilities					
	Borrowings	13	15.14	57.17	216.12	475.15
	Lease liabilities	14	249.30	278.57	346.62	389.54
	Provisions	15	161.92	156.12	138.25	133.83
	Deferred tax liabilities (Net)	16	242.47	275.61	241.48	273.55
	Other non-current liabilities	17	9.93	9.31	8.82	5.63
	<b>Total non-current liabilities</b>		<b>678.76</b>	<b>776.78</b>	<b>951.29</b>	<b>1,277.70</b>
	<b>CURRENT LIABILITIES</b>					
	Financial liabilities					
	Borrowings	13	1,394.44	1,220.60	2,348.85	2,981.13
	Lease liabilities	14	52.53	65.32	72.42	73.39
	Derivative instruments		-	-	54.49	-
	Trade payables due to:					
	Micro and small enterprises	18	391.97	380.06	146.36	125.90
	Other than micro and small enterprises	18	468.67	520.86	380.45	572.46
	Other liabilities	17	286.24	270.78	321.13	262.62
	Provisions	15	51.90	54.73	63.07	64.87
	Current tax liabilities (Net)		88.40	49.76	7.76	6.49
	<b>Total current liabilities</b>		<b>2,734.15</b>	<b>2,562.11</b>	<b>3,394.53</b>	<b>4,086.86</b>
	<b>Total liabilities</b>		<b>3,412.91</b>	<b>3,338.89</b>	<b>4,345.82</b>	<b>5,364.56</b>
	<b>TOTAL EQUITY AND LIABILITIES</b>		<b>10,072.53</b>	<b>8,932.70</b>	<b>8,987.47</b>	<b>9,584.37</b>

The above Restated Consolidated Statement of Assets and Liabilities should be read in conjunction with Notes to the Restated Consolidated Financial Information appearing in Annexure - V and Summary of Restatement Adjustments appearing in Annexure - VI.

**Uniparts India Limited**  
**Annexure I - Restated Consolidated Statement of Assets and Liabilities**  
**(All amounts are in Rs. million, unless stated otherwise)**

The accompanying notes are an integral part of the restated consolidated financial information.	
As per our report of even date <b>For Rakesh Banwari &amp; Co.</b> Chartered Accountants Firm Regn. No.009732N	For and on behalf of Board of Directors of <b>Uniparts India Limited</b>
<b>Rakesh Aggarwal</b> (Proprietor) Membership No. 088193	<b>Gurdeep Soni</b> (Chairman & Managing Director) (Vice Chairman & Director) [DIN: 00011478]
<b>Place : New Delhi</b> <b>Date : 22 March 2022</b>	<b>Paramjit Singh Soni</b> [DIN: 00011616]  <b>Munish Sapra</b> (Chief Financial Officer)  <b>Jatin Mahajan</b> (Company Secretary) [FCS: 6887]

**Uniparts India Limited**  
**Annexure II - Restated Consolidated Statement of Profit and Loss**  
**(All amounts are in Rs. million, unless stated otherwise)**

	Particulars	Annexure V Note	For the period ended 31st December 2021	For the year ended 31st March 2021	For the year ended 31st March 2020	For the year ended 31st March 2019
I	Revenue from operations	19	8,808.92	9,031.42	9,072.20	10,605.66
II	Other income	20	32.97	445.47	316.18	19.12
III	<b>Total income (I+II)</b>		<b>8,841.89</b>	<b>9,476.89</b>	<b>9,388.38</b>	<b>10,624.78</b>
IV	<b>Expenses</b>					
	Cost of materials consumed	21	3,862.24	3,381.77	3,323.20	4,282.84
	Changes in inventories of finished goods, work-in-progress, stock-in-trade and scrap	22	(1,121.17)	147.13	(35.34)	(559.60)
	Employee benefits expense	23	1,605.86	1,854.48	2,117.62	2,217.42
	Finance costs	24	42.28	81.07	179.65	181.98
	Depreciation and amortization expenses	25	271.66	372.59	354.42	300.96
	Other expenses	26	2,481.48	2,454.25	2,704.80	3,285.64
	<b>Total expenses (IV)</b>		<b>7,142.35</b>	<b>8,291.29</b>	<b>8,644.35</b>	<b>9,709.24</b>
V	<b>Restated profit before tax (III-IV)</b>		<b>1,699.54</b>	<b>1,185.60</b>	<b>744.03</b>	<b>915.54</b>
VI	<b>Tax expense</b>					
	Current tax	27	512.01	245.54	127.53	203.76
	MAT credit	27	-	-	19.06	(4.60)
	Deferred tax	27	(35.83)	16.20	(28.98)	20.41
	<b>Total tax expenses (VI)</b>		<b>476.18</b>	<b>261.74</b>	<b>117.61</b>	<b>219.57</b>
VII	<b>Restated profit for the period / year (V- VI)</b>		<b>1,223.36</b>	<b>923.86</b>	<b>626.42</b>	<b>695.97</b>

**Uniparts India Limited**
**Annexure II - Restated Consolidated Statement of Profit and Loss**

(All amounts are in Rs. million, unless stated otherwise)

	Particulars	Annexure V Note	For the period ended 31st December 2021	For the year ended 31st March 2021	For the year ended 31st March 2020	For the year ended 31st March 2019
VIII	<b>Restated other comprehensive income / (loss)</b>					
	<b>Items that will not be reclassified to Profit or Loss</b>					
	Re-measurement gains / (losses) of defined benefit plans		(12.24)	0.69	9.45	(10.60)
	Income tax relating to items that will not be reclassified to profit/loss		3.08	(0.17)	(2.41)	3.50
	<b>Items that will be reclassified to profit or loss</b>					
	Effective portion of cash flow hedge		10.06	89.87	(69.19)	14.70
	Exchange differences in translating the financial statements of foreign operations		(14.83)	(43.50)	(101.55)	(73.63)
	Income tax relating to items that will be reclassified to profit/loss		(2.53)	(22.62)	17.41	(5.14)
	<b>Restated other comprehensive income / (loss) for the period / year, net of tax</b>		<b>(16.46)</b>	<b>24.27</b>	<b>(146.29)</b>	<b>(71.17)</b>
IX	<b>Restated total comprehensive income for the period / year (VII+VIII)</b>		<b>1,206.90</b>	<b>948.13</b>	<b>480.13</b>	<b>624.80</b>
X	<b>Restated earnings per equity share attributable to owners of parent</b>	28				
	Basic earnings per share (in Rs.)		27.73	20.95	14.20	15.78
	Diluted earnings per share (in Rs.)		27.11	20.47	13.88	15.42

**Uniparts India Limited**

**Annexure II - Restated Consolidated Statement of Profit and Loss**

**(All amounts are in Rs. million, unless stated otherwise)**

The above Restated Consolidated Statement of Profit and Loss should be read in conjunction with Notes to the Restated Consolidated Financial Information appearing in Annexure - V and Summary of Restatement Adjustments appearing in Annexure - VI.

The accompanying notes are an integral part of the restated consolidated financial information.

As per our report of even date

**For Rakesh Banwari & Co.**

Chartered Accountants

Firm Regn. No.009732N

**Rakesh Aggarwal**

(Proprietor)

Membership No. 088193

**Place : New Delhi**

**Date : 22 March 2022**

For and on behalf of Board of Directors of  
**Uniparts India Limited**

**Gurdeep Soni**

(Chairman & Managing Director) (Vice Chairman & Director)  
[DIN: 00011478]

**Paramjit Singh Soni**

[DIN: 00011616]

**Munish Sapra**

(Chief Financial Officer)

**Jatin Mahajan**

(Company Secretary)

[FCS: 6887]

**Uniparts India Limited**  
**Annexure III - Restated Consolidated Statement of Cash Flows**  
**(All amounts are in Rs. million, unless stated otherwise)**

	Particulars	For the period ended 31st December 2021	For the year ended 31st March 2021	For the year ended 31st March 2020	For the year ended 31st March 2019
<b>A</b>	<b>Cash flow from operating activities:</b>				
	<b>Restated profit before tax</b>	1,699.54	1,185.60	744.03	915.54
	<b>Adjustments for:</b>				
	Depreciation and amortization expenses	271.66	372.59	354.42	300.96
	Interest expenses	22.83	53.61	135.99	147.76
	Interest on lease liabilities	11.59	18.20	20.03	10.70
	Interest income	(8.53)	(7.82)	(12.35)	(4.93)
	Deferred tax	(32.59)	11.34	(17.07)	6.39
	Expense on employee stock option scheme	7.85	4.03	5.85	1.99
	Transitional impact of Ind AS 116	-	-	10.57	(9.55)
	Reclassification of cash flow hedge	-	-	-	(1.26)
	(Profit) / loss on sale of property, plant and equipment	0.93	8.23	(62.69)	(0.20)
	Fixed assets written-off	-	0.84	0.73	3.97
	Unrealised foreign exchange (gain)/ loss	(27.40)	(32.85)	13.89	(3.50)
	Exchange difference on translation of assets and liabilities	(48.31)	(29.99)	(147.19)	(106.86)
	<b>Operating profit before working capital changes</b>	<b>1,897.57</b>	<b>1,583.78</b>	<b>1,046.21</b>	<b>1,261.01</b>
	<b>Adjustments for changes in working capital :</b>				
	(Increase)/decrease in loans	(0.33)	(1.74)	3.20	(2.63)
	(Increase)/decrease in other financial assets (non-current)	(1.75)	5.99	0.92	(2.76)
	(Increase)/decrease in other non-current assets	3.82	(17.86)	23.00	27.27
	(Increase)/decrease in inventories	(1,154.92)	138.38	145.49	(632.87)
	(Increase)/decrease in trade receivables	76.29	(434.04)	288.45	(339.45)
	(Increase)/decrease in derivative instruments	-	-	-	1.92
	(Increase)/decrease in other financial assets (current)	0.01	-	0.07	0.23
	(Increase)/decrease in current tax assets (net)	44.24	(0.57)	14.24	(30.10)
	(Increase)/decrease in other current assets	(48.24)	113.06	42.90	(15.40)
	Increase/(decrease) in provisions (non-current)	(6.44)	18.56	13.87	10.26
	Increase/(decrease) in other non-current liabilities	0.62	0.49	3.19	(16.71)
	Increase/(decrease) in trade payables	(39.00)	374.11	(173.02)	(144.24)
	Increase/(decrease) in other current liabilities	22.93	(24.53)	40.29	22.37
	Increase/(decrease) in current tax liabilities	38.64	42.00	1.27	(6.44)
	Increase/(decrease) in provisions (current)	(2.83)	(8.34)	(1.80)	9.54
	<b>Cash generated from/(used in) operations</b>	<b>830.61</b>	<b>1,789.29</b>	<b>1,448.28</b>	<b>142.00</b>



**Uniparts India Limited**  
**Annexure III - Restated Consolidated Statement of Cash Flows**  
(All amounts are in Rs. million, unless stated otherwise)

	Particulars	For the period ended 31st December 2021	For the year ended 31st March 2021	For the year ended 31st March 2020	For the year ended 31st March 2019
	Less: Income tax (paid) / refunds	(476.18)	(261.74)	(117.61)	(198.51)
	<b>Net cash flow from/ (used in) operating activities</b>	<b>354.43</b>	<b>1,527.55</b>	<b>1,330.67</b>	<b>(56.51)</b>
<b>B.</b>	<b>Cash flow from investing activities:</b>				
	Payments for purchase of property, plant and equipment and capital work in progress	(249.24)	(161.21)	(214.47)	(1,079.90)
	Payments for purchase of intangible assets	(2.47)	(2.32)	(30.26)	(21.25)
	Proceeds from sale of property, plant and equipment	3.15	10.83	131.27	14.30
	Investment in financial instrument	(5.08)	(12.50)	-	-
	Interest received	8.53	7.82	12.35	4.93
	<b>Net cash flow from/ (used in) investing activities</b>	<b>(245.11)</b>	<b>(157.38)</b>	<b>(101.11)</b>	<b>(1,081.92)</b>
<b>C.</b>	<b>Cash flow from financing activities</b>				
	Proceeds/(repayment) from short term borrowings	185.25	(1,108.32)	(707.91)	766.36
	Proceeds from long term borrowings	-	-	-	350.00
	Increase/(decrease) in lease liabilities	(42.06)	(75.15)	(43.89)	462.92
	Interest on lease liabilities	(11.59)	(18.20)	(20.03)	(10.70)
	Repayment of long term borrowings	(42.03)	(158.95)	(259.03)	(117.83)
	Interest paid	(22.83)	(53.61)	(135.99)	(147.76)
	Payment of dividend on equity shares (including DDT)	(148.94)	-	(65.29)	(54.41)
	<b>Net cash flow from/ (used in) financing activities</b>	<b>(82.20)</b>	<b>(1,414.23)</b>	<b>(1,232.14)</b>	<b>1,248.58</b>

**Uniparts India Limited**  
**Annexure III - Restated Consolidated Statement of Cash Flows**  
**(All amounts are in Rs. million, unless stated otherwise)**

<b>Particulars</b>	<b>For the period ended 31st December 2021</b>	<b>For the year ended 31st March 2021</b>	<b>For the year ended 31st March 2020</b>	<b>For the year ended 31st March 2019</b>
<b>Net increase/(decrease) in cash and cash equivalents (A+B+C)</b>	<b>27.12</b>	<b>(44.06)</b>	<b>(2.58)</b>	<b>110.15</b>
<b>Cash and Cash Equivalents at the beginning of the period / year</b>	<b>108.18</b>	<b>169.56</b>	<b>150.93</b>	<b>91.49</b>
Net increase/(decrease) in temporary overdraft	(7.47)	(25.82)	18.22	(53.19)
Effects of exchange difference on cash and cash equivalent held in foreign currency	3.90	8.50	2.99	2.48
<b>Cash and Cash Equivalents as at the end of the period / year (Refer note 9)</b>	<b>131.73</b>	<b>108.18</b>	<b>169.56</b>	<b>150.93</b>
<b>a) The above Restated Consolidated Statement of Cash Flows has been prepared under the “Indirect Method” as set out in the Indian Accounting Standard (Ind AS-7) - “Statement of Cash Flows”.</b>				
<b>b) Components of cash and cash equivalents as at (Refer note 9)</b>				
<b>Cash and cash equivalents comprises :</b>				
Cash in hand	0.84	1.00	1.94	3.28
Balances with banks	130.89	107.18	167.27	75.23
Other bank balances	-	-	0.35	72.42
<b>Total</b>	<b>131.73</b>	<b>108.18</b>	<b>169.56</b>	<b>150.93</b>

**Uniparts India Limited**  
**Annexure III - Restated Consolidated Statement of Cash Flows**  
**(All amounts are in Rs. million, unless stated otherwise)**

**c) Disclosure as required by Ind AS 7 - "Cash Flow Statements" - change in liabilities arising from financing activities:-**

<b>Particulars</b>	<b>For the period ended 31st December 2021</b>	<b>For the year ended 31st March 2021</b>	<b>For the year ended 31st March 2020</b>	<b>For the year ended 31st March 2019</b>
<b>Opening balance</b>	1,277.77	2,564.97	3,456.28	2,433.38
<b>Non cash movement</b>				
Exchange (Gain)/Loss	(11.41)	(19.93)	75.63	24.37
Interest Cost	22.83	53.61	135.99	147.76
<b>Cash movement</b>				
Principal repayment of long term borrowings	(42.03)	(158.95)	(259.03)	(117.83)
Proceeds from long term borrowings	-	-	-	350.00
Net short term Borrowing	185.25	(1,108.32)	(707.91)	766.36
Interest Payment	(22.83)	(53.61)	(135.99)	(147.76)
<b>Closing balance</b>	<b>1,409.58</b>	<b>1,277.77</b>	<b>2,564.97</b>	<b>3,456.28</b>

The above Restated Consolidated Statement of Cash Flows should be read in conjunction with Notes to the Restated Consolidated Financial Information appearing in Annexure - V and Summary of Restatement Adjustments appearing in Annexure - VI.

The accompanying notes are an integral part of the restated consolidated financial information.

As per our report of even date

**For Rakesh Banwari & Co.**

Chartered Accountants

Firm Regn. No.009732N

**Rakesh Aggarwal**

(Proprietor)

Membership No. 088193

**Place : New Delhi**

**Date : 22 March 2022**

For and on behalf of Board of Directors of  
**Uniparts India Limited**

**Gurdeep Soni**

(Chairman & Managing Director)

[DIN: 00011478]

**Paramjit Singh Soni**

(Vice Chairman & Director)

[DIN: 00011616]

**Munish Sapra**

(Chief Financial Officer)

**Jatin Mahajan**

(Company Secretary)

[FCS: 6887]

**Uniparts India Limited**  
**Annexure IV - Restated Consolidated Statement of Changes in Equity**  
 (All amounts are in Rs. million, unless stated otherwise)

**A. Equity share capital**

<b>Particulars</b>	<b>Annexure V Note</b>	<b>Equity Share Capital</b>
<b>As at 1st April, 2018</b>	11	451.34
Change during the year		-
<b>As at 31st March, 2019</b>	11	451.34
Change during the year		-
<b>As at 31st March, 2020</b>	11	451.34
Change during the year		-
<b>As at 31st March, 2021</b>	11	451.34
Change during the period		-
<b>As at 31st December, 2021</b>	11	451.34

There are no Changes in Equity Share Capital due to prior period errors.

**Uniparts India Limited**
**Annexure IV - Restated Consolidated Statement of Changes in Equity**

(All amounts are in Rs. million, unless stated otherwise)

**B. Other equity**

Particulars	Reserves and Surplus					Items of other comprehensive income		Total
	Security premium	General reserve	Retained earnings	Special Economic Zone re-investment reserve	Employees Stock Options Outstanding	Exchange differences in translating the financial statements of foreign operations	Effective portion of cash flow hedge	
<b>Restated balance as at 1st April, 2018</b>	837.56	12.05	3,014.91	-	28.15	(636.51)	1.26	<b>3,257.42</b>
<b>Restatement adjustments</b>								
-Ind AS 116 transition adjustment (Refer Annexure VI - Summary of Restatement Adjustments)	-	-	(8.05)	-	-	1.88	-	(6.17)
-Earlier Year Tax Impact	-	-	1.36	-	-	-	-	1.36
Restated profit for the year	-	-	695.97	-	-	-	-	695.97
Restated other comprehensive income for the year	-	-	(7.10)	-	-	(75.51)	8.30	(74.31)
<b>Restated total comprehensive income for the year</b>	<b>837.56</b>	<b>12.05</b>	<b>3,697.09</b>	<b>-</b>	<b>28.15</b>	<b>(710.14)</b>	<b>9.56</b>	<b>3,874.27</b>
Payment of dividend on equity shares	-	-	(45.13)	-	-	-	-	(45.13)
Tax on dividend	-	-	(16.97)	-	-	-	-	(16.97)
Reversal of tax on dividend	-	-	7.70	-	-	-	-	7.70
Transfer to special economic zone re-investment reserve	-	-	(110.00)	110.00	-	-	-	-
ESOP granted during the year	-	-	-	-	1.99	-	-	1.99
	<b>837.56</b>	<b>12.05</b>	<b>3,532.69</b>	<b>110.00</b>	<b>30.14</b>	<b>(710.14)</b>	<b>9.56</b>	<b>3,821.86</b>
Amount recoverable from uniparts employees stock option	48.25	-	-	-	-	-	-	48.25
<b>Restated balance as at 31st March, 2019</b>	<b>789.31</b>	<b>12.05</b>	<b>3,532.69</b>	<b>110.00</b>	<b>30.14</b>	<b>(710.14)</b>	<b>9.56</b>	<b>3,773.61</b>

**Uniparts India Limited**
**Annexure IV - Restated Consolidated Statement of Changes in Equity**

(All amounts are in Rs. million, unless stated otherwise)

Particulars	Reserves and Surplus					Items of other comprehensive income		Total
	Security premium	General reserve	Retained earnings	Special Economic Zone re-investment reserve	Employees Stock Options Outstanding	Exchange differences in translating the financial statements of foreign operations	Effective portion of cash flow hedge	
<b>Ind AS 116 transition adjustment (Refer Annexure VI - Summary of Restatement Adjustments)</b>	-	-	1.15	-	-	(1.88)	-	(0.73)
<b>As at 1st April, 2019</b>	<b>837.56</b>	<b>12.05</b>	<b>3,533.84</b>	<b>110.00</b>	<b>30.14</b>	<b>(712.02)</b>	<b>9.56</b>	<b>3,772.88</b>
Restated profit for the year	-	-	626.42	-	-	-	-	626.42
Restated other comprehensive income for the year	-	-	7.04	-	-	(99.67)	(51.78)	(144.41)
<b>Restated total comprehensive income for the year</b>	<b>837.56</b>	<b>12.05</b>	<b>4,167.30</b>	<b>110.00</b>	<b>30.14</b>	<b>(811.69)</b>	<b>(42.22)</b>	<b>4,303.14</b>
Payment of dividend on equity shares	-	-	(54.16)	-	-	-	-	(54.16)
Tax on dividend	-	-	(21.79)	-	-	-	-	(21.79)
Reversal of tax on dividend	-	-	10.66	-	-	-	-	10.66
Transfer from special economic zone re-investment reserve	-	-	38.16	(38.16)	-	-	-	-
ESOP granted during the year	-	-	-	-	5.85	-	-	5.85
	<b>837.56</b>	<b>12.05</b>	<b>4,140.17</b>	<b>71.84</b>	<b>35.99</b>	<b>(811.69)</b>	<b>(42.22)</b>	<b>4,243.70</b>
Amount recoverable from uniparts employees stock option	48.25	-	-	-	-	-	-	48.25
<b>Restated balance as at 31st March, 2020</b>	<b>789.31</b>	<b>12.05</b>	<b>4,140.17</b>	<b>71.84</b>	<b>35.99</b>	<b>(811.69)</b>	<b>(42.22)</b>	<b>4,195.45</b>

**Uniparts India Limited**
**Annexure IV - Restated Consolidated Statement of Changes in Equity**

(All amounts are in Rs. million, unless stated otherwise)

Particulars	Reserves and Surplus					Items of other comprehensive income		Total
	Security premium	General reserve	Retained earnings	Special Economic Zone re-investment reserve	Employees Stock Options Outstanding	Exchange differences in translating the financial statements of foreign operations	Effective portion of cash flow hedge	
<b>As at 1st April, 2020</b>	<b>837.56</b>	<b>12.05</b>	<b>4,140.17</b>	<b>71.84</b>	<b>35.99</b>	<b>(811.69)</b>	<b>(42.22)</b>	<b>4,243.70</b>
Restated profit for the year	-	-	923.86	-	-	-	-	923.86
Restated other comprehensive income for the year	-	-	0.52	-	-	(43.50)	67.25	24.27
<b>Restated total comprehensive income for the year</b>	<b>837.56</b>	<b>12.05</b>	<b>5,064.55</b>	<b>71.84</b>	<b>35.99</b>	<b>(855.19)</b>	<b>25.03</b>	<b>5,191.83</b>
Payment of dividend on equity shares	-	-	-	-	-	-	-	-
Tax on dividend	-	-	-	-	-	-	-	-
Reversal of tax on dividend	-	-	-	-	-	-	-	-
Transfer from special economic zone re-investment reserve	-	-	10.97	(10.97)	-	-	-	-
ESOP granted during the year	-	-	-	-	4.03	-	-	4.03
	<b>837.56</b>	<b>12.05</b>	<b>5,075.52</b>	<b>60.87</b>	<b>40.02</b>	<b>(855.19)</b>	<b>25.03</b>	<b>5,195.86</b>
Amount recoverable from uniparts employees stock option	48.25	-	-	-	-	-	-	48.25
<b>Restated balance as at 31st March, 2021</b>	<b>789.31</b>	<b>12.05</b>	<b>5,075.52</b>	<b>60.87</b>	<b>40.02</b>	<b>(855.19)</b>	<b>25.03</b>	<b>5,147.61</b>

**Uniparts India Limited**
**Annexure IV - Restated Consolidated Statement of Changes in Equity**

(All amounts are in Rs. million, unless stated otherwise)

Particulars	Reserves and Surplus					Items of other comprehensive income		Total
	Security premium	General reserve	Retained earnings	Special Economic Zone re-investment reserve	Employees Stock Options Outstanding	Exchange differences in translating the financial statements of foreign operations	Effective portion of cash flow hedge	
<b>As at 1st April, 2021</b>	<b>837.56</b>	<b>12.05</b>	<b>5,075.52</b>	<b>60.87</b>	<b>40.02</b>	<b>(855.19)</b>	<b>25.03</b>	<b>5,195.86</b>
Restated profit for the period	-	-	1,223.36	-	-	-	-	1,223.36
Restated other comprehensive income for the period	-	-	(9.16)	-	-	(14.83)	7.53	(16.46)
<b>Restated total comprehensive income for the period</b>	<b>837.56</b>	<b>12.05</b>	<b>6,289.72</b>	<b>60.87</b>	<b>40.02</b>	<b>(870.02)</b>	<b>32.56</b>	<b>6,402.76</b>
Payment of dividend on equity shares	-	-	(148.94)	-	-	-	-	(148.94)
Tax on dividend	-	-	-	-	-	-	-	-
Reversal of tax on dividend	-	-	-	-	-	-	-	-
Transfer to Securities premium	-	-	-	-	(0.43)	-	-	(0.43)
Amount recognised during the year	0.43	-	-	-	-	-	-	0.43
Transfer from special economic zone re-investment reserve	-	-	31.51	(31.51)	-	-	-	-
Transfer to special economic zone re-investment reserve	-	-	-	-	-	-	-	-
ESOP granted during the period	-	-	-	-	7.85	-	-	7.85
	<b>837.99</b>	<b>12.05</b>	<b>6,172.29</b>	<b>29.36</b>	<b>47.44</b>	<b>(870.02)</b>	<b>32.56</b>	<b>6,261.67</b>
Amount recoverable from uniparts employees stock option	48.25	-	-	-	-	-	-	48.25
<b>Restated balance as at 31st December, 2021</b>	<b>789.74</b>	<b>12.05</b>	<b>6,172.29</b>	<b>29.36</b>	<b>47.44</b>	<b>(870.02)</b>	<b>32.56</b>	<b>6,213.42</b>



**Uniparts India Limited**  
**Annexure IV - Restated Consolidated Statement of Changes in Equity**  
**(All amounts are in Rs. million, unless stated otherwise)**

The above Restated Consolidated Statement of Changes in Equity should be read in conjunction with Notes to the Restated Consolidated Financial Information appearing in Annexure - V and Summary of Restatement Adjustments appearing in Annexure - VI.

The accompanying notes are an integral part of the restated consolidated financial information.

As per our report of even date

**For Rakesh Banwari & Co.**

Chartered Accountants

Firm Regn. No.009732N

**Rakesh Aggarwal**

(Proprietor)

Membership No. 088193

**Place : New Delhi**

**Date : 22 March 2022**

For and on behalf of Board of Directors of  
**Uniparts India Limited**

**Gurdeep Soni**

(Chairman & Managing Director)

[DIN: 00011478]

**Paramjit Singh Soni**

(Vice Chairman & Director)

[DIN: 00011616]

**Munish Sapra**

(Chief Financial Officer)

**Jatin Mahajan**

(Company Secretary)

[FCS: 6887]

## **Uniparts India Limited**

### **Annexure V - Notes to the Restated Consolidated Financial Information**

**(All amounts are in Rs. million, unless stated otherwise)**

#### **1) Corporate Information**

The restated consolidated financial statements comprise restated financial statements of Uniparts India Limited (“the Company”) and its subsidiaries (collectively, the Group). The Company was incorporated under the provisions of erstwhile Companies Act, 1956. The Company is domiciled in India having its registered office at Gripwel House, Block-5, C6 & 7, Vasant Kunj, New Delhi 110070, India. The Group is engaged into the objects of, inter-alia, manufacturing, sale and export of Linkage parts and Components for Off-Highway Vehicles. Information on other related party relationships of the Group is provided in Note 38.

The Group caters to both the domestic and international markets. The Company’s CIN is U74899DL1994PLC061753. The restated consolidated financial statements were authorized for issue in accordance with a resolution of the Board of Directors in its meeting held on 22nd March 2022.

#### **2. SIGNIFICANT ACCOUNTING POLICIES:**

##### **2.1) Basis of Preparation**

The Restated Consolidated Financial Information of the Group comprises of the Restated Consolidated Statement of Assets and Liabilities as at 31st December 2021, 31st March 2021, 31st March 2020 and 31st March 2019, the Restated Consolidated Statement of Profit and Loss, the Restated Consolidated Statement of Changes in Equity and Restated Consolidated Statement of Cash Flows for the period/year ended 31st December 2021, 31st March 2021, 31st March 2020 and 31st March 2019, Notes to the Restated Consolidated Financial Information and Summary of Restatement Adjustments (collectively, the ‘Restated Consolidated Financial Information’) have been prepared in accordance with the Indian Accounting Standards (Ind AS) notified under Section 133 of the Companies Act 2013 (“the Act”) read with Rule 3 of the Companies (Indian Accounting Standard) Rules, 2015 and Companies (Indian Accounting Standards) Amendment Rule, 2016 and other relevant provisions of the Act.

The Restated Consolidated Financial Information have been prepared on a going concern basis. The accounting policies are applied consistently to all the periods presented in the Restated Consolidated Financial Information.

The Restated Consolidated Financial Information has been prepared for inclusion in the Offer Document to be filed by the Company with the Securities and Exchange Board of India (‘SEBI’) in connection with proposed Initial Public Offering of its equity shares, in accordance with the requirements of:

- Section 26 of part I of Chapter III of the Act;
- relevant provisions of the Securities and Exchange Board of India (Issue of Capital and Disclosure Requirements) Regulations, 2018, issued by the Securities and Exchange Board of India (‘SEBI’) as amended in pursuance of the Securities and Exchange Board of India Act, 1992; and
- Guidance Note on Reports in Company Prospectuses (Revised 2019) issued by the Institute of Chartered Accountants of India (‘ICAI’).

A new lease standard i.e., Ind AS 116 “Leases” has been notified to be effective w.e.f. 1st April 2019 which provide guidelines for the accounting of the lease contracts entered in the capacity of a lessee and a lessor. For the purpose of preparation of Restated Consolidated Financial Information, the Management has evaluated the impact of change in accounting policies on adoption of Ind AS 116 for the year ended 31st March 2019. Hence in these Restated Consolidated Financial Information, Ind AS 116 has been adopted with effect from 1st April 2018 following modified retrospective method (i.e. 1st April 2018 the Group has measured the lease liability at the present value of the remaining lease payments, discounted using the lessee’s incremental borrowing rate and right-of-use assets are measured at their carrying amount as if Ind AS 116 had been applied since the commencement date, discounted using the lessee's incremental borrowing rate at the date of initial application).

The Restated Consolidated financial statements are presented in Indian Rupees (Rs.), which is also its functional currency and all values are rounded to the nearest million (‘0,00,000), except when otherwise indicated.

## **Uniparts India Limited**

### **Annexure V - Notes to the Restated Consolidated Financial Information (All amounts are in Rs. million, unless stated otherwise)**

#### **2.2) Basis of Consolidation**

The Restated Consolidated financial information comprise the financial statements of the Company and its subsidiaries as at 31st December 2021, 31st March 2021, 31st March 2020 and March 31 2019. Subsidiary companies are all entities over which the Group has control. The control is achieved when the Group is exposed to, or has rights to, variable returns from its involvement with the entity and has the ability to affect those returns through its power to direct the relevant activities of the entity.

The Group re-assesses whether or not it controls an entity in case facts and circumstances indicate that there are changes to one or more of the elements of control. Consolidation of a subsidiary begins when the Group obtains control over the subsidiary and ceases when the Group loses control of the subsidiary. Assets, liabilities, income and expenses of a subsidiary acquired or disposed of during the year are included in the Restated Consolidated financial information from the date the Group gains control until the date the Group ceases to control the subsidiary. Intercompany transactions, balances and unrealised gain/loss on transactions between Group companies are eliminated.

The Restated Consolidated financial information are prepared using uniform accounting policies for like transactions and other events in similar circumstances. If a member of the Group uses accounting policies other than those adopted in the Restated Consolidated financial information for like transactions and events in similar circumstances, appropriate adjustments are made to that Group member's financial statements in preparing the Restated Consolidated financial information to ensure conformity with the Group's accounting policies.

#### **2.3) Business combinations and goodwill**

At the acquisition date, the identifiable assets acquired and the liabilities assumed are recognised at their acquisition date fair values. For this purpose, the liabilities assumed include contingent liabilities representing present obligation and they are measured at their acquisition fair values irrespective of the fact that outflow of resources embodying economic benefits is not probable. However, the following assets and liabilities acquired in a business combination are measured at the basis indicated below:

Deferred tax assets or liabilities, and the assets or liabilities related to employee benefit arrangements are recognised and measured in accordance with Ind AS 12 Income Tax and Ind AS 19 Employee Benefits respectively.

When the Group acquires a business, it assesses the financial assets and liabilities assumed for appropriate classification and designation in accordance with the contractual terms, economic circumstances and pertinent conditions as at the acquisition date. This includes the separation of embedded derivatives in host contracts by the acquire.

Contingent consideration classified as an asset or liability that is a financial instrument and within the scope of Ind AS 109 Financial Instruments, is measured at fair value with changes in fair value recognised in the statement of profit and loss. If the contingent consideration is not within the scope of Ind AS 109, it is measured in accordance with the appropriate Ind AS. Contingent consideration that is classified as equity is not remeasured at subsequent reporting dates and subsequent its settlement is accounted for within equity.

Goodwill is initially measured at cost, being the excess of the aggregate of the consideration transferred and the amount recognised for non-controlling interests, and any previous interest held, over the net identifiable assets acquired and liabilities assumed. If the fair value of the net assets acquired is in excess of the aggregate consideration transferred, the Group reassesses whether it has correctly identified all of the assets acquired and all of the liabilities assumed and reviews the procedures used to measure the amounts to be recognised at the acquisition date. If the reassessment still results in an excess of the fair value of net assets acquired over the aggregate consideration transferred, then the gain is recognised in Other Comprehensive Income (OCI) and accumulated in equity as capital reserve. However, if there is no clear evidence of bargain purchase, the Company recognises the gain directly in equity as capital reserve, without routing the same through OCI.

After initial recognition, goodwill is measured at cost less any accumulated impairment losses. For the purpose of impairment testing, goodwill acquired in a business combination is, from the acquisition date, allocated to each of the Group's cash-generating units that are expected to benefit from the combination, irrespective of whether other assets or liabilities of the acquirer are assigned to those units.

## **Uniparts India Limited**

### **Annexure V - Notes to the Restated Consolidated Financial Information (All amounts are in Rs. million, unless stated otherwise)**

#### **2.4) Current versus non-current classification**

The assets and liabilities are presented as current or non-current in the balance sheet by the Group.

An asset is treated as current when it is expected that it will be realised or intended to be sold or consumed in normal operating cycle, it is held primarily for trading purposes, it is expected to be realised within twelve months after the reporting period or cash or cash equivalents unless restricted from being exchanged or used to settle a liability for at least twelve months after the reporting period.

All other assets are treated as non-current in the balance sheet.

A liability is treated as current when it is expected to be settled in normal operating cycle, if it is held primarily for the purpose of trading, it is due to be settled within twelve months after the end of the reporting period or there is no unconditional right to defer the settlement of the liability for at least twelve months after the reporting period.

The Group classifies all other liabilities as non-current in the balance sheet.

The Group identifies its operating cycle as twelve months.

Deferred tax asset and liabilities are classified as non-current assets or liabilities in the balance sheet.

#### **2.5) Critical Accounting Judgments & key sources of Estimation uncertainties**

The following are the critical judgments and the key estimates concerning the future that management has made in the process of applying the Group's accounting policies and these may have the most significant effect on the amounts recognized in the Restated Consolidated financial information or have a significant risk of causing a material adjustment to the carrying amounts of assets and liabilities within the next financial year. The estimates and associated assumptions are based on historical experiences and other factors that are considered to be relevant. The estimates and underlying assumptions are reviewed on an on-going basis. Revision of accounting estimates are recognised in the period in which the estimates are revised if the revision affects only that period or in the period of the revision and future periods where revision affects both current and future periods.

#### **Intangible Assets**

Capitalization of cost for intangible assets and intangible assets under development is based on the management judgment that technological and economic feasibility is confirmed and assets under development will generate economic benefits in future. Based on the evaluation carried out, the Group's management has determined that there are no factors which indicate that those assets have suffered any impairment loss.

#### **Useful life of depreciable Assets**

Management reviews the useful life of depreciable assets at each reporting date. As at 31st December 2021 management assessed that the useful life represents the expected utility of the assets by the Group. Further there is no significant change in useful life as compared to the previous year.

#### **Impairment of non-financial assets**

The Group assesses at each reporting date whether there is an indication that an asset may be impaired. If any indication exist, or when annual impairment testing for an asset is required, the Group estimates the asset's recoverable amount. An asset's recoverable amount is the higher of an asset's or Cash Generating Unit's (CGU) fair value less costs of disposal and its value in use. It is determined for an individual asset, unless the asset or CGU exceeds its recoverable amount, the asset is considered impaired and is written down to its recoverable amount.

## **Uniparts India Limited**

### **Annexure V - Notes to the Restated Consolidated Financial Information (All amounts are in Rs. million, unless stated otherwise)**

In assessing the value in use, the estimated future cash flows are discounted to their present value using a pre-tax discount rate that reflects current market assessments of the time value of money and risks specific to the asset. In determining the fair value less costs to disposal, recent market transactions are taken into account. If no such transactions can be identified, an appropriate valuation model is used.

Intangible assets under development are tested for impairment annually. Impairment losses including impairment on inventories are recognised in the Consolidated statement of profit and loss.

#### **Impairment of financial assets**

The impairment provisions for financial assets are based on assumptions about risk of default and expected loss rates. The Group uses judgment in making these assumptions and selecting the inputs to the impairment calculation, based on Group's past history, existing market conditions as well as forward looking estimates at the end of each reporting period.

#### **Defined benefit plans**

The cost of the defined benefit gratuity plan, other post-employment plans and the present value of the gratuity obligation is determined using actuarial valuations. An actuarial valuation involves making various assumptions that may differ from actual developments in the future. These include the determination of the discount rate, future salary increases and mortality rates. Due to the complexities involved in the valuation and its long-term nature, a defined benefit obligation is highly sensitive to changes in these assumptions. All assumptions are reviewed at each reporting date.

The mortality rate is based on publicly available mortality tables for India. Those mortality tables tend to change only at interval in response to demographic changes.

Further details about gratuity obligations are given in Note 32

#### **Fair value measurement of financial instruments**

When the fair values of financial assets and financial liabilities recorded in the balance sheet cannot be measured based on quoted prices in active markets, their fair value is measured using suitable valuation techniques. The inputs to these models are taken from observable markets where possible, but where this is not feasible, a degree of judgment is required in establishing fair values. Judgments include considerations of inputs such as liquidity risk, credit risk and volatility. Changes in assumptions about these factors could affect the reported fair value of financial instruments. See Note 42 for

#### **Income tax and deferred tax**

Significant management judgment is required to determine the amount of deferred tax assets that can be recognised, based upon the likely timing and the level of future taxable profits together with future tax planning strategies.

### **2.6) Financial Instruments**

A financial instrument is any contract that gives rise to a financial asset of one entity and a financial liability or equity instrument of another entity.

#### **Initial Recognition and measurement**

On initial recognition, all the financial assets are recognized at their fair value plus or minus, in the case of a financial asset or financial liability not at fair value through profit or loss (FVTPL), transaction costs that are directly attributable to the acquisition or issue of the financial asset or financial liability.

All financial liabilities are recognised initially at fair value and, in the case of loans, borrowings and payables, net of directly attributable transaction costs.

The Group's financial liabilities include trade and other payables, loans and borrowings including bank overdrafts and derivative financial instruments.

## **Uniparts India Limited**

### **Annexure V - Notes to the Restated Consolidated Financial Information (All amounts are in Rs. million, unless stated otherwise)**

#### **Subsequent measurement**

##### **(i) Financial assets carried at amortised cost**

A financial asset is subsequently measured at amortised cost if it is held within a business model whose objective is to hold the asset in order to collect contractual cash flows and the contractual terms of the financial asset give rise on specified dates to cash flows that are solely payments of principal and interest on the principal amount outstanding.

The trade & other receivables, after initial measurement are subsequently measured at amortised cost using the effective interest rate (EIR) method. Amortised cost is calculated by taking into account any discount or premium on acquisition and fees or costs that are an integral part of the EIR. The EIR amortisation is included in other income in the statement of profit and loss. The losses arising from impairment are recognised in the statement of profit and loss.

##### **(ii) Financial assets at fair value through other comprehensive income (FVTOCI)**

A financial asset is subsequently measured at fair value through other comprehensive income if it is held within a business model whose objective is achieved by both collecting contractual cash flows and selling financial assets, and the contractual terms of the financial asset give rise on specified dates to cash flows that are solely payments of principal and interest on the principal amount outstanding.

Financial assets included within the FVTOCI are measured initially as well as at each reporting date at fair value. Fair value movements are recognized in the other comprehensive income (OCI). However, the Group recognizes interest income, impairment losses, reversals and foreign exchange gain or loss in the statement of profit and loss. On derecognition of the asset, cumulative gain or loss previously recognised in OCI is reclassified from the equity to statement of profit and loss. Interest earned whilst holding FVTOCI debt instrument is reported as interest income using the EIR method.

##### **(iii) Financial assets at fair value through profit or loss (FVTPL)**

A financial asset which is not classified in any of the above categories is subsequently measured at fair value through profit or loss.

##### **(iv) Financial liabilities**

a) The financial liabilities are subsequently carried at amortized cost using the effective interest method. For trade and other payables maturing within one year from the balance sheet date, the carrying amounts approximate fair value due to the short-term maturity of these instruments. This category also includes derivative financial instruments entered into by the Group that are not designated as hedging instruments in hedge relationships as defined by Ind AS 109.

b) Loans and borrowings is the category most relevant to the Group. After initial recognition, interest-bearing loans and borrowings are subsequently measured at amortised cost using the EIR method. Gains and losses are recognised in statement of profit and loss when the liabilities are derecognised as well as through the EIR amortisation process. In the calculation of amortised cost, discount or premium on acquisition and fees or costs that are an integral part of the EIR are taken into account. This category generally applies to borrowings.

## **Uniparts India Limited**

### **Annexure V - Notes to the Restated Consolidated Financial Information**

**(All amounts are in Rs. million, unless stated otherwise)**

#### **Fair value measurement of financial instruments**

The fair value of financial instruments is determined using the valuation techniques that are appropriate in the circumstances and for which sufficient data are available to measure fair value, maximising the use of relevant observable inputs and minimising the use of unobservable inputs.

Based on the three level fair value hierarchy, the methods used to determine the fair value of financial assets and liabilities include quoted market price, discounted cash flow analysis and valuation certified by the external valuer.

In case of financial instruments where the carrying amount approximates fair value due to the short maturity of those instruments, carrying amount is considered as fair value.

#### **Derecognition of financial instrument**

A financial asset is derecognized when the contractual rights to the cash flows from the financial asset expire or has transferred the financial asset and the transfer qualifies for derecognition under Ind AS 109.

When the Group has transferred its rights to receive cash flows from an asset or has entered into a pass through arrangement, it evaluates if and to what extent it has retained the risks and rewards of ownership. When it has neither transferred nor retained substantially all of the risks and rewards of the asset, nor transferred control of the asset, the Group continues to recognise the transferred asset to the extent of the Group's continuing involvement. In that case, the Group also recognises an associated liability. The transferred asset and the associated liability are measured on a basis that reflects the rights and obligations that the Group has retained.

A financial liability is derecognized when the obligation specified in the contract is discharged or cancelled or expired. When an existing financial liability is replaced by another from the same lender on substantially different terms, or the terms of an existing liability are substantially modified, such an exchange or modification is treated as the derecognition of the original liability and the recognition of a new liability. The difference in the respective carrying amounts is recognised in the statement of profit and loss.

#### **2.7) Inventories**

Inventories are valued as below:

- (i) Raw Materials, Packing Materials and Consumable Stores & Spares are valued at cost computed on FIFO method.
- (ii) Work-in-progress are valued at materials cost plus appropriate share of labour and production overheads incurred till the stage of completion of production.
- (iii) Finished Goods are valued at lower of the cost or net realizable value.
- (iv) Scrap is valued at net realizable value calculated based on last month's average realization.

#### **2.8) Revenue Recognition**

Revenue is recognised to the extent it is probable that the economic benefits will flow to the Group and the revenue can be reliably measured, regardless of when the payment is being made. Revenue is measured at the fair value of the consideration received or receivable, taking into account contractually defined terms of payment and excluding taxes or duties collected on behalf of the government.

## **Uniparts India Limited**

### **Annexure V - Notes to the Restated Consolidated Financial Information**

**(All amounts are in Rs. million, unless stated otherwise)**

Revenue is presented net of Goods & Service Tax , wherever applicable. However, Goods & Service Tax (GST) is not received by the Group on its own account. Rather, it is tax collected on value added to the commodity by the Group on behalf of the Government. Accordingly, these are excluded from revenue.

The specific recognition criteria as described below must also be met before revenue is recognised.

#### **Sale of Goods**

Revenue is recognised when the customer obtains control of the goods. The customer obtains control of goods at the different point in time based on the delivery terms. Accordingly, Group satisfies its performance obligation at the time of dispatch of goods from the factory/stockyard/storage area/port as the case may be and accordingly revenue is recognised. Revenue from the sale of goods is measured at the fair value of the consideration received or receivable, net of returns and allowances, trade discounts and volume rebates.

The determination of transaction price, its allocation to promised goods and allocation of discount or variable compensation (if any) is done based on the contract with the customers.

The incremental costs that the Group incurs to obtain a contract with a customer that it would not have incurred if the contract had not been obtained are recognised as an asset if its recovery is expected and its amortisation period is more than one year, all other such costs are recognised as an expense in Consolidated statement of profit and loss. The incremental cost recognised as an asset is amortised over the period till when such cost is expected to be recovered. Amount so recovered is recognised as revenue in Consolidated statement of profit and loss.

#### **Export incentives**

Revenue from export incentives are accounted for on export of goods if the entitlements can be estimated with reasonable assurance and conditions precedent to claim are fulfilled.

#### **Die design and preparation charges**

Revenues from die design and preparation charges are recognized as per the terms of the contract as and when the significant risks and rewards of ownership of dies are transferred to the buyers.

#### **Interest income**

For all debt instruments measured either at amortised cost or at fair value through other comprehensive income, interest income is recorded using the effective interest rate (EIR). EIR is the rate that exactly discounts the estimated future cash receipts over the expected life of the financial instrument or a shorter period, where appropriate, to the gross carrying amount of the financial asset or to the amortised cost of a financial liability. When calculating the effective interest rate, the Group estimates the expected cash flows by considering all the contractual terms of the financial instrument (for example, prepayment, extension, call and similar options) but does not consider the expected credit losses. Interest income is included in other income in the statement of profit and loss.

#### **Dividends**

Dividend income is recognised when the Group's right to receive the payment is established, which is generally when shareholders approve the dividend.

#### **Insurance and other claims**

Insurance and other claims are recognised as revenue only when it is reasonably certain that the ultimate collection will be made.



## Uniparts India Limited

### Annexure V - Notes to the Restated Consolidated Financial Information

(All amounts are in Rs. million, unless stated otherwise)

#### 2.9) Government grants

Government grants are recognised where there is reasonable assurance that the grant will be received and all attached conditions will be complied with. When the grant or subsidy relates to revenue, it is recognized as income on a systematic basis in the consolidated statement of profit and loss over the periods necessary to match them with the related costs, which they are intended to compensate.

Where the grant relates to an asset, it is recognized as deferred income and is allocated to consolidated statement of profit and loss over the periods and in the proportions in which depreciation on those assets is charged.

#### 2.10) Property, Plant & Equipment

##### Tangible Assets

Depreciation on tangible assets is provided on the straight-line method at the rates and manner prescribed under Schedule II of the Companies Act, 2013 except in the case of Plant and Machinery where the depreciation has been provided on the basis of the useful lives of the assets estimated by the management based on internal assessment and independent technical evaluation carried out by external Chartered Engineer at the time of adoption of Companies Act, 2013. Depreciation for the assets purchased / sold during the year is proportionately charged.

The estimated useful lives are as mentioned below:

Type of Asset	Method	Useful Lives
Leasehold land	Straight Line	Over the period of lease or estimated useful life, whichever is lower.
Factory Building	Straight Line	30 Years
Furniture & Fittings	Straight Line	10 Years
Plant and Machinery	Straight Line	10 - 20 Years
Office Equipment	Straight Line	5 Years
Computers	Straight Line	3 -6 Years
Vehicles	Straight Line	8-10 Years

An item of property, plant and equipment and any significant part initially recognised is derecognised upon disposal or when no future economic benefits are expected from its use or disposal. Any gain or loss arising on derecognition of the asset (calculated as the difference between the net disposal proceeds and the carrying amount of the asset) is included in the income statement when the asset is derecognised.

The residual values, useful lives and methods of depreciation of property, plant and equipment are reviewed at each financial year end and adjusted prospectively, if appropriate.

## **Uniparts India Limited**

### **Annexure V - Notes to the Restated Consolidated Financial Information**

**(All amounts are in Rs. million, unless stated otherwise)**

Property, plant and equipment are stated at cost of acquisition or construction net of accumulated depreciation and impairment loss (if any). Internally manufactured property, plant and equipment are capitalized at cost, including non-cenvatable excise duty, wherever applicable, GST wherever applicable. All significant costs relating to the acquisition and installation of property, plant and equipment are capitalised. Such cost includes the cost of replacing part of the property, plant and equipment and borrowing costs for long-term construction projects if the recognition criteria are met. When significant parts of plant and equipment are required to be replaced at intervals, the Group depreciates them separately based on their specific useful lives. Likewise, when a major inspection is performed, its cost is recognised in the carrying amount of the plant and equipment as a replacement if the recognition criteria are satisfied. All other repair and maintenance costs are recognised in statement of profit and loss as incurred. The present value of the expected cost for the decommissioning of an asset after its use is included in the cost of the respective asset if the recognition criteria for a provision are met. Refer to note regarding significant accounting judgments, estimates and assumptions and provisions for further information.

Subsequent costs are included in the asset's carrying amount or recognised as a separate asset, as appropriate, only when it is probable that future economic benefits associated with the item will flow to the Group and the cost of the item can be measured reliably. The carrying amount of the replaced part is derecognised.

#### **2.11) Intangible Assets**

##### **Recognition and initial measurement**

Purchased Intangible assets are stated at cost less accumulated amortisation and impairment, if any.

##### **Internally developed intangible assets**

Expenditure on the research phase of projects is recognised as an expense as incurred.

Costs that are directly attributable to a project's development phase are recognised as intangible assets, provided the Company can demonstrate the following:

- the technical feasibility of completing the intangible asset so that it will be available for use.
- its intention to complete the intangible asset and use or sell it
- its ability to use or sell the intangible asset
- how the intangible asset will generate probable future economic benefits
- the availability of adequate technical, financial and other resources to complete the development and to use or sell the intangible asset.
- its ability to measure reliably the expenditure attributable to the intangible asset during its development costs not meeting these criteria for capitalisation are expensed as incurred.

Directly attributable costs include employee costs incurred on development of prototypes along with an appropriate portion of relevant overheads and borrowing costs.

##### **Goodwill**

Goodwill is initially measured at cost, being the excess of the aggregate of the consideration transferred and the amount recognised for non-controlling interests, and any previous interest held, over the net identifiable assets acquired and liabilities assumed. If the fair value of the net assets acquired is in excess of the aggregate consideration transferred, the Group re-assesses whether it has correctly identified all of the assets acquired and all of the liabilities assumed and reviews the procedures used to measure the amounts to be recognised at the acquisition date. If the reassessment still results in an excess of the fair value of net assets acquired over the aggregate consideration transferred, then the gain is recognised in OCI and accumulated in equity as capital reserve. However, If there is no clear evidence of bargain purchase, the entity recognises the gain directly in equity as capital reserve, without routing the same through OCI.

## **Uniparts India Limited**

### **Annexure V - Notes to the Restated Consolidated Financial Information**

**(All amounts are in Rs. million, unless stated otherwise)**

After initial recognition, goodwill is measured at cost less any accumulated impairment losses. For the purpose of impairment testing, goodwill acquired in a business combination is, from the acquisition date, allocated to each of the Group's cash-generating units that are expected to benefit from the combination, irrespective of whether other assets or liabilities of the acquire are assigned to those units.

#### **2.12) Foreign Currency Transactions**

##### **Functional and presentation currency**

The financial statements are presented in Indian Rupee (INR) and are rounded to two decimal places of Million, which is also the functional and presentation currency of the Group.

##### **Transactions and balances**

Foreign currency transactions are recorded in the functional currency, by applying to the exchange rate between the functional currency and the foreign currency at the date of the transaction.

Foreign currency monetary items are converted to functional currency using the closing rate. Non-monetary items denominated in a foreign currency which are carried at historical cost are reported using the exchange rate at the date of the transactions.

Exchange differences arising on monetary items on settlement, or restatement as at reporting date, at rates different from those at which they were initially recorded, are recognized in the statement of profit and loss in the year in which they arise.

#### **2.13) Employee Benefits**

##### **(i) Short term employee benefits**

All employee benefits that are expected to be settled wholly within twelve months after the end of the period in which the employees render the related service, are classified as short term employee benefits, which include salaries, wages, short term compensated absences and performance incentives and are measured at the amounts expected to be paid when the liabilities are settled. The liabilities are presented as current employee benefit obligations in the balance sheet. These are recognised as expenses in the period in which the employee renders the related service.

##### **(ii) Post-employment benefits**

Contributions towards Superannuation Fund, Pension Fund and government administered Provident Fund are treated as defined contribution schemes. In respect of contributions made to government administered Provident Fund, the Group has no further obligations beyond its monthly contributions. Such contributions are recognised as expense in the period in which the employee renders related service.

The cost of defined benefit such as is determined using the projected unit credit method, with actuarial valuation being carried out at each balance sheet date. Actuarial gains and losses in respect of the same are charged to the Other Comprehensive Income (OCI).

**Uniparts India Limited**

**Annexure V - Notes to the Restated Consolidated Financial Information**

**(All amounts are in Rs. million, unless stated otherwise)**

**(iii) Other long-term benefits**

All employee benefits other than post-employment benefits and termination benefits, which do not fall due wholly within twelve months after the end of the period in which the employees render the related service, including long term compensated absences, service awards, and ex-gratia are determined based on actuarial valuation carried out at each balance sheet date. Estimated liability on account of long term employee benefits is discounted to the present value using the yield on government bonds as the discounting rate for the term of obligations as on the date of the balance sheet. Actuarial gains and losses in respect of the same are charged to the statement of profit and loss.

**(iv) Termination benefits**

Termination benefits are payable when employment is terminated by the Group before the normal retirement date, or when an employee accepts voluntary retirement in exchange of these benefits. The Group recognises termination benefits at the earlier of the following dates:

- (a) when the Group can no longer withdraw the offer of those benefits; and
- (b) when the entity recognises costs for a restructuring that is within the scope of Ind AS 37 and involves the payment of termination benefits. The termination benefits are measured based on the number of employees expected to accept the offer in case of voluntary retirement scheme.

## **Uniparts India Limited**

### **Annexure V - Notes to the Restated Consolidated Financial Information (All amounts are in Rs. million, unless stated otherwise)**

#### **2.14) Leases**

##### **(i) Determining whether an arrangement contains a lease**

At inception of a contract, the Group determines whether the contract is, or contains, a lease. The contract is, or contains, a lease if the contract conveys the right to control the use of an identified asset or assets for a period of time in exchange for consideration, even if that right is not explicitly specified in a contract.

At inception or on reassessment of a contract that contains lease component and one or more additional lease or non-lease components, the Group separates payments and other consideration required by the contract into those for each lease component on the basis of their relative Consolidated price and those for non-lease components on the basis of their relative aggregate stand-alone price. If the Group concludes that it is impracticable to separate the payments reliably, then right-of-use asset and Lease liability are recognised at an amount equal to the present value of future lease payments; subsequently the liability is reduced as payments are made and an imputed finance cost on the liability is recognised using the Group's incremental borrowing rate.

The previous determination pursuant to Ind AS 17 and its 'Appendix C' of whether a contract is a lease has been maintained for existing contracts.

##### **(ii) Group as a lessee**

At inception, the Group assesses whether a contract is or contains a lease. This assessment involves the exercise of judgement about whether it depends on an identified asset, whether the Group obtains substantially all the economic benefits from the use of that asset, and whether the Group has the right to direct the use of that asset.

The Group has elected to separate lease and nonlease components of contracts, wherever possible. The Group recognizes a right-of-use asset and a lease liability at the transition date/ lease commencement date. The right-of-use asset is initially measured based on the present value of future lease payments, plus initial direct costs wherever identifiable, and cost to dismantle and remove the underlying asset or to restore the underlying asset or the site on which it is located, and lease payments made at or before the commencement date, less any incentives received. The right-of-use asset is depreciated over the shorter of the lease term or the useful life of the underlying asset. The right of-use asset is subject to testing for impairment if there is an indicator for impairment.

At the commencement date, Group measures the lease liability at the present value of the future lease payments that are not yet paid at that date discounted using interest rate implicit in the lease or, if that rate cannot be readily determined, the Group's incremental borrowing rate. Generally, the Group's uses its incremental borrowing rate as the discount rate. The lease liability is measured at amortised cost using the effective interest method. Lease liabilities are remeasured with a corresponding adjustment to the related right of use asset, if the Company changes its assessment whether it will exercise an extension or a termination option.

Contingent rents payments are recognised as an expense in the period in which they are incurred. Lease payments generally include fixed payments and variable payments that depend on an index (such as an inflation index). When the lease contains an extension or purchase option that the Group considers reasonably certain to be exercised, the cost of the option is included in the lease payments.

The Group has elected not to recognize right-of-use assets and liabilities for leases where the total lease term is less than or equal to 12 months, or for leases of low value assets. The payments for such leases are recognized in the Consolidated Statement of Profit and Loss on a straight-line basis over the lease term.

##### **(iii) Group as a lessor**

Leases for which the Group is a lessor is classified as a finance or operating lease. Whenever the terms of the lease transfer substantially all the risks and rewards of ownership to the lessee, the contract is classified as a finance lease. All other leases are classified as operating leases.

When the Group is an intermediate lessor, it accounts for its interests in the head lease and the sublease separately. The sublease is classified as a finance or operating lease by reference to the right-of-use asset arising from the head lease.

For operating leases. rental income is recognised on a straight-line basis over the term of the relevant lease.

## **Uniparts India Limited**

### **Annexure V - Notes to the Restated Consolidated Financial Information**

**(All amounts are in Rs. million, unless stated otherwise)**

#### **2.15) Taxation**

##### **a) Current Tax**

Current income tax assets and liabilities are measured at the amount expected to be recovered from or paid to the taxation authorities. The tax rates and tax laws used to compute the amount are those that are enacted or substantively enacted, at the reporting date in the countries where the Group operates and generates taxable income.

Current income tax relating to items recognised outside profit or loss is recognised outside profit or loss (either in other comprehensive income or in equity). Current tax items are recognised in correlation to the underlying transaction either in OCI or directly in equity. Management periodically evaluates positions taken in the tax returns with respect to situations in which applicable tax regulations are subject to interpretation and establishes provisions where appropriate.

##### **b) Deferred Tax**

Deferred income tax is provided in full, using the liability method, on temporary differences arising between the tax bases of assets and liabilities and their carrying amounts in the financial statements. Deferred tax assets are recognised and carried forward only if it is probable that sufficient future taxable income will be available against which such deferred tax assets can be realised. Deferred tax assets and liabilities are measured at the tax rates that have been enacted or substantively enacted as on the balance sheet date. Deferred tax assets and deferred tax liabilities are offset when there is a legally enforceable right to set off assets against liabilities representing current tax. Current and deferred tax is recognised in profit and loss, except to the extent that it relates to items recognised in other comprehensive income. In this case, the tax is also recognised in other comprehensive income.

The carrying amount of deferred tax assets is reviewed at the end of each reporting period and reduced to the extent that it is no longer probable that sufficient taxable profits will be available to allow all or part of the asset to be recovered.

#### **2.16) Employee Stock options**

The Group has accounted for the share based payment for employees in respect of Group's ESOP - based on the IND AS 102 " Share-based payments" and Guidance Note on "Accounting for Employees Share Based Payment" issued by ICAI ("Guidance Note"). The Group follows the Fair Market Value Method (calculated on the basis of Black-Scholes method) to account for compensation expenses arising from issuance of stock options to the employees and has recognized the services received in an equity-settled employee share-based payment plan as an expense when it receives the services, with a corresponding credit to Stock Options Outstanding Account. Further, employees compensation cost recognized earlier on grant of options is reversed in the year when the Options are surrendered by the employee.

#### **2.17) Borrowings & Borrowing Costs**

Borrowings are recognised initially at fair value, net of transaction costs incurred. Borrowings are subsequently stated at amortised cost. Any difference between the proceeds (net of transaction costs) and the redemption value is recognised in the income statement over the period of the borrowings using the effective interest rate method. Borrowings are classified as current liabilities unless the Group has an unconditional right to defer settlement of the liability for at least 12 months after the reporting date.

Borrowing costs directly attributable to the acquisition, construction or production of qualifying assets, which are assets that necessarily take a substantial period of time to get ready for their intended use or sale, are added to the cost of those assets, until such time as the assets are substantially ready for their intended use or sale.

Interest income earned on the temporary investment of specific borrowings, pending their expenditure on qualifying assets, is deducted from the borrowing costs eligible for capitalisation.

All other borrowing costs are recognised in consolidated statement of profit and loss in the period in which they are

## **Uniparts India Limited**

### **Annexure V - Notes to the Restated Consolidated Financial Information**

**(All amounts are in Rs. million, unless stated otherwise)**

#### **2.18) Impairment of Assets**

##### **Non-financial assets**

Intangible assets and property, plant and equipment are evaluated for recoverability whenever events or changes in circumstances indicate that their carrying amounts may not be recoverable. For the purpose of impairment testing, the recoverable amount (i.e. the higher of the fair value less cost to sell and the value-in-use) is determined on an individual asset basis unless the asset does not generate cash flows that are largely independent of those from other assets. In such cases, the recoverable amount is determined for the CGU to which the asset belongs.

If such assets are considered to be impaired, the impairment to be recognized in the consolidated statement of profit and loss is measured by the amount by which the carrying value of the assets exceeds the estimated recoverable amount of the asset. An impairment loss is reversed in the statement of profit and loss if there has been a change in the estimates used to determine the recoverable amount. The carrying amount of the asset is increased to its revised recoverable amount, provided that this amount does not exceed the carrying amount that would have been determined (net of any accumulated amortization or depreciation) had no impairment loss been recognized for the asset in prior years.

##### **Financial assets**

The Group recognizes loss allowances using the expected credit loss (ECL) model for the financial assets which are not fair valued through profit or loss.

Loss allowance for trade receivables with no significant financing component is measured at an amount equal to lifetime ECL.

#### **2.19) Cash and Cash Equivalents**

Cash and cash equivalents includes cash and cheques in hand, current accounts and fixed deposit accounts with banks with original maturities of three months or less that are readily convertible to known amounts of cash and which are subject to an insignificant risk of changes in value.

#### **2.20) Cash Flow Statement**

Cash flows are reported using the indirect method, whereby a profit before tax is adjusted for the effects of transactions of non-cash nature and any deferrals or accruals of past or future cash receipts or payments. The cash flows from operating, financing and investing activities of the Group are segregated.

#### **2.21) Provisions and Contingencies**

Provisions are recognised when the Group has a present legal or constructive obligation as a result of past events, for which it is probable that an outflow of resources embodying economic benefits will be required to settle the obligation and a reliable estimate of the amount can be made.

Provisions are measured at the present value of management's best estimate of the expenditure required to settle the present obligation at the end of the reporting period. The discount rate to determine the present value is a pre-tax rate that reflects current market assessments of the time value of money and the risks specific to the liability. The increase in the provision due to the passage of time is recognised as interest expense.

Contingent liabilities are disclosed when there is a possible obligation arising from past events, the existence of which will be confirmed only by the occurrence or non occurrence of one or more uncertain future events not wholly within the control of the Group or a present obligation that arises from past events where it is either not probable that an outflow of resources will be required to settle or a reliable estimate of the amount cannot be made.

## **Uniparts India Limited**

### **Annexure V - Notes to the Restated Consolidated Financial Information (All amounts are in Rs. million, unless stated otherwise)**

#### **2.22) Derivative financial instruments and hedge accounting**

##### **Cash Flow Hedge:**

The Group enters into derivative financial instruments such as foreign exchange forward and option contracts to mitigate the risk of changes in exchange rates on foreign currency exposures.

The effective portion of changes in the fair value of the hedging instruments is recognized in other comprehensive income and accumulated in the cash flow hedging reserve. Such amounts are reclassified in to the consolidated statement of profit or loss when the related hedge items affect profit or loss. Any ineffective portion of changes in the fair value of the derivative or if the hedging instrument no longer meets the criteria for hedge accounting, is recognized immediately in the statement of profit and loss.

Any derivative that is either not designated a hedge, or is so designated but is ineffective as per Ind AS 109, is categorized as a financial instruments at fair value through profit or loss.

#### **2.23) Dividend to equity holders of the Group**

The Group recognises a liability to make cash or non-cash distributions to equity holders of the Group when the distribution is authorised and the distribution is no longer at the discretion of the Group. As per the Corporate laws in India, a distribution is authorised when it is approved by the shareholders. A corresponding amount is recognised directly in other equity.

#### **2.24) Segment reporting**

Operating segments are reported in a manner consistent with the internal reporting provided to the chief operating decision-maker.

#### **2.25) Earnings Per Share**

Earning per share is calculated by dividing the profit attributable to owners of the Group by the weighted average number of equity shares outstanding during the financial year.

For the purpose of calculating diluted earnings per share, the net profit or loss for the year attributable to equity shareholders and the weighted average number of shares outstanding during the year are adjusted for the effects of all dilutive potential equity shares.



**Uniparts India Limited**  
**Annexure V - Notes to the Restated Consolidated Financial Information**  
(All amounts are in Rs. million, unless stated otherwise)

**3(a). Property, plant and equipment**

Particulars	Land	Buildings	Leasehold Improvement	Plant & Machinery	Furniture & fixtures	Vehicles	Office Equipments	Computers	Total
<b>Gross carrying amount</b>									
<b>As at 1st April 2018</b>	<b>34.33</b>	<b>622.99</b>	<b>15.17</b>	<b>2,492.36</b>	<b>49.31</b>	<b>82.58</b>	<b>113.04</b>	<b>118.09</b>	<b>3,527.87</b>
Exchange diff	-	3.78	-	49.86	0.14	1.37	-	0.65	55.80
Additions	-	188.06	-	554.31	8.35	16.25	11.89	17.44	796.30
Disposals / Adjustments	-	-	-	58.24	5.87	10.85	7.76	17.20	99.92
<b>As at 31st March 2019</b>	<b>34.33</b>	<b>814.83</b>	<b>15.17</b>	<b>3,038.29</b>	<b>51.93</b>	<b>89.35</b>	<b>117.17</b>	<b>118.98</b>	<b>4,280.05</b>
Exchange diff	-	5.75	-	81.33	0.21	2.06	-	1.07	90.42
Additions	-	9.62	-	123.37	1.09	18.66	6.56	14.90	174.20
Disposals / Adjustments	-	54.47	-	14.75	0.27	26.84	0.92	3.01	100.26
<b>As at 31st March 2020</b>	<b>34.33</b>	<b>775.73</b>	<b>15.17</b>	<b>3,228.24</b>	<b>52.96</b>	<b>83.23</b>	<b>122.81</b>	<b>131.94</b>	<b>4,444.41</b>
Exchange diff	-	(0.46)	-	(26.67)	(0.07)	(0.74)	(1.94)	(0.55)	(30.43)
Additions	-	71.34	-	127.92	2.07	11.87	5.53	6.23	224.96
Disposals / Adjustments	-	-	15.17	194.24	3.21	14.56	1.01	1.23	229.42
<b>As at 31st March 2021</b>	<b>34.33</b>	<b>846.61</b>	<b>-</b>	<b>3,135.25</b>	<b>51.75</b>	<b>79.80</b>	<b>125.39</b>	<b>136.39</b>	<b>4,409.52</b>
Exchange diff	-	0.29	-	13.58	0.04	0.46	1.21	0.34	15.92
Additions	-	2.13	-	186.73	0.42	5.75	9.43	7.52	211.98
Disposals / Adjustments	-	-	-	19.65	0.07	2.44	1.23	0.09	23.48
<b>As at 31st December 2021</b>	<b>34.33</b>	<b>849.03</b>	<b>-</b>	<b>3,315.91</b>	<b>52.14</b>	<b>83.57</b>	<b>134.80</b>	<b>144.16</b>	<b>4,613.94</b>

**Uniparts India Limited**  
**Annexure V - Notes to the Restated Consolidated Financial Information**  
(All amounts are in Rs. million, unless stated otherwise)

**3(a). Property, plant and equipment**

Particulars	Land	Buildings	Leasehold Improvement	Plant & Machinery	Furniture & fixtures	Vehicles	Office Equipments	Computers	Total
<b>Accumulated depreciation</b>									
<b>As at 1st April 2018</b>	-	<b>179.97</b>	<b>9.91</b>	<b>1,438.95</b>	<b>38.03</b>	<b>56.98</b>	<b>96.06</b>	<b>92.02</b>	<b>1,911.92</b>
Exchange diff	-	1.15	-	42.36	0.12	0.87	-	0.61	45.11
Charge for the year	-	24.36	1.72	176.01	2.88	6.75	2.87	10.43	225.02
Disposals / Adjustments	-	-	-	42.01	5.48	10.24	7.43	16.68	81.84
<b>As at 31st March 2019</b>	-	<b>205.48</b>	<b>11.63</b>	<b>1,615.31</b>	<b>35.55</b>	<b>54.36</b>	<b>91.50</b>	<b>86.38</b>	<b>2,100.21</b>
Exchange diff	-	1.95	-	67.12	0.18	1.52	-	1.02	71.79
Charge for the year	-	26.26	1.72	201.49	2.61	9.26	4.38	12.39	258.11
Disposals / Adjustments	-	16.77	-	11.50	0.21	24.07	0.63	2.48	55.66
<b>As at 31st March 2020</b>	-	<b>216.92</b>	<b>13.35</b>	<b>1,872.42</b>	<b>38.13</b>	<b>41.07</b>	<b>95.25</b>	<b>97.31</b>	<b>2,374.45</b>
Exchange diff	-	(0.28)	-	(22.61)	(0.07)	(0.49)	(1.68)	(0.36)	(25.49)
Charge for the year	-	26.73	1.06	210.12	2.33	8.68	10.26	11.60	270.78
Disposals / Adjustments	-	(3.06)	14.41	184.09	3.05	11.58	0.91	1.15	212.13
<b>As at 31st March 2021</b>	-	<b>246.43</b>	-	<b>1,875.84</b>	<b>37.34</b>	<b>37.68</b>	<b>102.92</b>	<b>107.40</b>	<b>2,407.61</b>
Exchange diff	-	0.21	-	11.27	0.04	0.36	1.13	0.26	13.27
Charge for the year	-	20.54	-	155.40	1.81	6.61	6.28	8.14	198.78
Disposals / Adjustments	-	-	-	15.76	0.07	2.32	1.16	0.09	19.40
<b>As at 31st December 2021</b>	-	<b>267.18</b>	-	<b>2,026.75</b>	<b>39.12</b>	<b>42.33</b>	<b>109.17</b>	<b>115.71</b>	<b>2,600.26</b>
<b>Net carrying amount</b>									
<b>As at 31st March 2019</b>	<b>34.33</b>	<b>609.35</b>	<b>3.54</b>	<b>1,422.98</b>	<b>16.38</b>	<b>34.99</b>	<b>25.67</b>	<b>32.60</b>	<b>2,179.84</b>
<b>As at 31st March 2020</b>	<b>34.33</b>	<b>558.81</b>	<b>1.82</b>	<b>1,355.82</b>	<b>14.83</b>	<b>42.16</b>	<b>27.56</b>	<b>34.63</b>	<b>2,069.96</b>
<b>As at 31st March 2021</b>	<b>34.33</b>	<b>600.18</b>	-	<b>1,259.41</b>	<b>14.41</b>	<b>42.12</b>	<b>22.47</b>	<b>28.99</b>	<b>2,001.91</b>
<b>As at 31st December 2021</b>	<b>34.33</b>	<b>581.85</b>	-	<b>1,289.16</b>	<b>13.02</b>	<b>41.24</b>	<b>25.63</b>	<b>28.45</b>	<b>2,013.68</b>

**Notes:**

1) Refer note 13 for information on property, plant and equipment pledged as security by the Group.

**Uniparts India Limited**  
**Annexure V - Notes to the Restated Consolidated Financial Information**  
**(All amounts are in Rs. million, unless stated otherwise)**

**3(b). Right of use assets**

**(i) Amounts recognised in Restated Consolidated Statement of Assets and Liabilities**

Set out below are the carrying amounts of right of use assets recognised and movements during the year/period:

Particulars	Land	Buildings	Plant and Machinery	Vehicles	Computer	Total
<b>Gross carrying amount</b>						
<b>As at 1st April 2018</b>	312.43	185.90	7.32	22.64	0.57	528.86
Exchange diff	1.34	(0.64)	0.37	1.02	(0.02)	2.07
Additions	-	292.02	2.47	-	-	294.49
Disposals / Adjustments	-	-	-	-	-	-
<b>As at 31st March 2019</b>	<b>313.77</b>	<b>477.28</b>	<b>10.16</b>	<b>23.66</b>	<b>0.55</b>	<b>825.42</b>
Ind AS 116 transition adjustment (Refer Annexure VI - Summary of Restatement Adjustments)	-	(61.94)	(5.31)	(6.98)	(0.22)	(74.45)
Exchange diff	0.56	24.90	0.45	1.28	0.02	27.21
Additions	-	1.28	1.14	3.39	-	5.81
Disposals / Adjustments	23.23	-	-	-	-	23.23
<b>As at 31st March 2020</b>	<b>291.10</b>	<b>441.52</b>	<b>6.44</b>	<b>21.35</b>	<b>0.35</b>	<b>760.76</b>
Exchange diff	-	(8.87)	0.04	(0.45)	0.01	(9.27)
Additions	-	-	2.05	3.86	0.68	6.59
Disposals / Adjustments	-	17.65	0.56	2.31	0.37	20.89
<b>As at 31st March 2021</b>	<b>291.10</b>	<b>415.00</b>	<b>7.97</b>	<b>22.45</b>	<b>0.67</b>	<b>737.19</b>
Exchange diff	-	5.43	(0.02)	0.28	(0.01)	5.68
Additions	-	-	1.13	1.49	-	2.62
Disposals / Adjustments	-	-	-	-	-	-
<b>As at 31st December 2021</b>	<b>291.10</b>	<b>420.43</b>	<b>9.08</b>	<b>24.22</b>	<b>0.66</b>	<b>745.49</b>

**Uniparts India Limited**  
**Annexure V - Notes to the Restated Consolidated Financial Information**  
**(All amounts are in Rs. million, unless stated otherwise)**

**3(b). Right of use assets**

**(i) Amounts recognised in Restated Consolidated Statement of Assets and Liabilities**

**Set out below are the carrying amounts of right of use assets recognised and movements during the year/period:**

<b>Particulars</b>	<b>Land</b>	<b>Buildings</b>	<b>Plant and Machinery</b>	<b>Vehicles</b>	<b>Computer</b>	<b>Total</b>
<b>Accumulated depreciation</b>						
<b>As at 1st April 2018</b>	6.54	-	-	-	-	6.54
Exchange diff	-	-	-	-	-	-
Charge for the year	6.55	53.20	3.72	6.02	0.21	69.70
Disposals / Adjustments	-	-	-	-	-	-
<b>As at 31st March 2019</b>	<b>13.09</b>	<b>53.20</b>	<b>3.72</b>	<b>6.02</b>	<b>0.21</b>	<b>76.24</b>
Ind AS 116 transition adjustment (Refer Annexure VI - Summary of Restatement Adjustments)	-	(53.20)	(3.72)	(6.02)	(0.21)	(63.15)
Exchange diff	-	-	-	-	-	-
Charge for the year	6.56	69.92	2.81	5.75	0.23	85.27
Disposals / Adjustments	-	-	-	-	-	-
<b>As at 31st March 2020</b>	<b>19.65</b>	<b>69.92</b>	<b>2.81</b>	<b>5.75</b>	<b>0.23</b>	<b>98.36</b>
Exchange diff	-	(1.10)	(0.01)	(0.09)	0.01	(1.19)
Charge for the year	6.55	66.72	2.00	4.77	0.25	80.29
Disposals / Adjustments	-	15.03	0.56	2.31	0.37	18.27
<b>As at 31st March 2021</b>	<b>26.20</b>	<b>120.51</b>	<b>4.24</b>	<b>8.12</b>	<b>0.12</b>	<b>159.19</b>
Exchange diff	-	1.35	0.02	0.11	-	1.48
Charge for the year	4.93	45.70	0.98	3.81	0.17	55.59
Disposals / Adjustments	-	-	-	-	-	-
<b>As at 31st December 2021</b>	<b>31.13</b>	<b>167.56</b>	<b>5.24</b>	<b>12.04</b>	<b>0.29</b>	<b>216.26</b>
<b>Net carrying amount</b>						
<b>As at 31st March 2019</b>	<b>300.68</b>	<b>424.08</b>	<b>6.44</b>	<b>17.64</b>	<b>0.34</b>	<b>749.18</b>
<b>As at 31st March 2020</b>	<b>271.45</b>	<b>371.60</b>	<b>3.63</b>	<b>15.60</b>	<b>0.12</b>	<b>662.40</b>
<b>As at 31st March 2021</b>	<b>264.90</b>	<b>294.49</b>	<b>3.73</b>	<b>14.33</b>	<b>0.55</b>	<b>578.00</b>
<b>As at 31st December 2021</b>	<b>259.97</b>	<b>252.87</b>	<b>3.84</b>	<b>12.18</b>	<b>0.37</b>	<b>529.23</b>

**Uniparts India Limited**  
**Annexure V - Notes to the Restated Consolidated Financial Information**  
**(All amounts are in Rs. million, unless stated otherwise)**

**3(b). Right of use assets (Continued.)**

Particulars	As at 31st December 2021	As at 31st March 2021	As at 31st March 2020	As at 31st March 2019
<b>Lease Liabilities</b>				
Current	52.53	65.32	72.42	73.39
Non-current	249.30	278.57	346.62	389.54
<b>Total</b>	<b>301.83</b>	<b>343.89</b>	<b>419.04</b>	<b>462.93</b>

**(ii) Amounts recognised in the Restated Consolidated Statement of Profit and loss**

The restated consolidated statement of profit or loss shows the following amounts relating to leases:

Particulars	Note	For the period ended 31st December 2021	For the year ended 31st March 2021	For the year ended 31st March 2020	For the year ended 31st March 2019
<b>Depreciation of right-of-use assets</b>					
Land	3(a)	4.93	6.55	6.56	6.55
Buildings	3(a)	45.70	66.72	69.92	53.20
Plant and Machinery	3(a)	0.98	2.00	2.81	3.72
Vehicles	3(a)	3.81	4.77	5.75	6.02
Computer	3(a)	0.17	0.25	0.23	0.21
		<b>55.59</b>	<b>80.29</b>	<b>85.27</b>	<b>69.70</b>
Interest expense (included in finance cost)	24	11.59	18.20	20.03	10.70
Expense relating to short- term leases (included in other expenses)	26	31.34	47.06	71.54	74.44

**Uniparts India Limited**  
**Annexure V - Notes to the Restated Consolidated Financial Information**  
**(All amounts are in Rs. million, unless stated otherwise)**

**3(c).Capital work - in - progress (CWIP)**

**(i) Amounts recognised in Restated Consolidated Statement of Assets and Liabilities**

**Set out below are the carrying amounts of right of use assets recognised and movements during the year/period:**

<b>Particulars</b>	<b>Plant &amp; Machinery</b>	<b>Office Equipments</b>	<b>Computers &amp; Accessories</b>	<b>Buildings</b>	<b>Commercial Vehicle</b>	<b>Other Expenses</b>	<b>Total</b>
<b>As at 1st April 2018</b>	<b>119.47</b>	<b>6.59</b>	<b>5.71</b>	<b>118.83</b>	<b>-</b>	<b>36.19</b>	<b>286.79</b>
Movement during the year	(76.68)	(6.30)	(3.88)	(104.99)	-	(36.19)	(228.04)
<b>As at 31st March 2019</b>	<b>42.79</b>	<b>0.29</b>	<b>1.83</b>	<b>13.84</b>	<b>-</b>	<b>-</b>	<b>58.75</b>
Movement during the year	21.13	(0.19)	(1.43)	14.95	-	-	34.46
<b>As at 31st March 2020</b>	<b>63.92</b>	<b>0.10</b>	<b>0.40</b>	<b>28.79</b>	<b>-</b>	<b>-</b>	<b>93.21</b>
Movement during the year	(47.05)	3.83	(0.40)	(27.66)	0.94	-	(70.34)
<b>As at 31st March 2021</b>	<b>16.87</b>	<b>3.93</b>	<b>-</b>	<b>1.13</b>	<b>0.94</b>	<b>-</b>	<b>22.87</b>
Movement during the period	39.80	(3.91)	0.25	(0.56)	(0.94)	-	34.64
<b>As at 31st December 2021</b>	<b>56.67</b>	<b>0.02</b>	<b>0.25</b>	<b>0.57</b>	<b>-</b>	<b>-</b>	<b>57.51</b>

**Uniparts India Limited****Annexure V - Notes to the Restated Consolidated Financial Information****(All amounts are in Rs. million, unless stated otherwise)****3(c).Capital work - in - progress (CWIP)****Notes:****i) Capital work - in - progress ageing schedule**

Projects in progress

Particulars	Amount in CWIP for a period of				Total
	Less than 1 year	1-2 years	2-3 years	More than 3 years	
As at 31st March 2019	47.14	9.64	1.97	-	<b>58.75</b>
As at 31st March 2020	63.33	24.91	4.97	-	<b>93.21</b>
As at 31st March 2021	22.70	0.17	-	-	<b>22.87</b>
As at 31st December 2021	49.59	7.80	0.12	-	<b>57.51</b>

ii) Actual cost of capital projects in progress has not exceeded the estimated cost and the actual timelines for completion of projects has not exceeded the estimated timelines in respect of the amounts reported above, as at the end of each reporting period. Accordingly, completion schedule is not presented.

**Uniparts India Limited**  
**Annexure V - Notes to the Restated Consolidated Financial Information**  
**(All amounts are in Rs. million, unless stated otherwise)**

**3(d).Other intangible assets**

<b>Particulars</b>	<b>Software</b>
<b>Gross carrying amount</b>	
<b>As at 1st April 2018</b>	<b>116.93</b>
Exchange diff	0.03
Additions	12.80
Disposals / Adjustments	0.17
<b>As at 31st March 2019</b>	<b>129.59</b>
Exchange diff	2.54
Additions	53.98
Disposals / Adjustments	1.50
<b>As at 31st March 2020</b>	<b>184.61</b>
Exchange diff	(1.25)
Additions	8.62
Disposals / Adjustments	0.08
<b>As at 31st March 2021</b>	<b>191.90</b>
Exchange diff	0.76
Additions	2.47
Disposals / Adjustments	-
<b>As at 31st December 2021</b>	<b>195.13</b>
<b>Accumulated depreciation</b>	
<b>As at 1st April 2018</b>	<b>99.16</b>
Exchange diff	0.03
Charge for the year	6.24
Disposals / Adjustments	0.17
<b>As at 31st March 2019</b>	<b>105.26</b>
Exchange diff	0.05
Charge for the year	11.04
Disposals / Adjustments	-
<b>As at 31st March 2020</b>	<b>116.35</b>
Exchange diff	(0.12)
Charge for the year	21.52
Disposals / Adjustments	0.08
<b>As at 31st March 2021</b>	<b>137.67</b>
Exchange diff	0.32
Charge for the year	17.29
Disposals / Adjustments	-
<b>As at 31st December 2021</b>	<b>155.28</b>
<b>Net carrying amount</b>	
<b>As at 31st March 2019</b>	<b>24.33</b>
<b>As at 31st March 2020</b>	<b>68.26</b>
<b>As at 31st March 2021</b>	<b>54.23</b>
<b>As at 31st December 2021</b>	<b>39.85</b>



**Uniparts India Limited**  
**Annexure V - Notes to the Restated Consolidated Financial Information**  
**(All amounts are in Rs. million, unless stated otherwise)**

**3(e).Intangible assets under development**

<b>Particulars</b>	<b>Intangible assets under development</b>
<b>Gross carrying amount</b>	
As at 1st April 2018	<b>21.60</b>
Movement during the year	8.42
<b>As at 31st March 2019</b>	<b>30.02</b>
Movement during the year	(23.72)
<b>As at 31st March 2020</b>	<b>6.30</b>
Movement during the year	(6.30)
<b>As at 31st March 2021</b>	<b>-</b>
Movement during the period	-
<b>As at 31st December 2021</b>	<b>-</b>

**Notes:**

**i) Intangible assets under development ageing schedule**

Projects in progress

<b>Particulars</b>	<b>Amount in CWIP for a period of</b>				<b>Total</b>
	<b>Less than 1 year</b>	<b>1-2 years</b>	<b>2-3 years</b>	<b>More than 3 years</b>	
As at 31st March 2019	13.32	4.42	8.82	3.46	<b>30.02</b>
As at 31st March 2020	0.67	1.10	0.42	4.11	<b>6.30</b>
As at 31st March 2021	-	-	-	-	-
As at 31st December 2021	-	-	-	-	-

ii) Actual cost of Intangible assets under development has not exceeded the estimated cost and the actual timelines for completion of projects has not exceeded the estimated timelines in respect of the amounts reported above, as at the end of each reporting period. Accordingly, completion schedule is not presented.

iii) Intangible assets under development majorly comprises of software under development.

**Uniparts India Limited**  
**Annexure V - Notes to the Restated Consolidated Financial Information**  
**(All amounts are in Rs. million, unless stated otherwise)**

**4. Other Financial Assets**

Particulars	As at 31st December 2021	As at 31st March 2021	As at 31st March 2020	As at 31st March 2019
<b>Non-current</b>				
Security deposits	46.11	44.36	50.34	51.32
Deposits with original maturity of more than twelve months	0.13	0.13	0.14	0.08
<b>Total</b>	<b>46.24</b>	<b>44.49</b>	<b>50.48</b>	<b>51.40</b>
<b>Current</b>				
Interest accrued but not due	0.32	0.33	0.33	0.40
<b>Total</b>	<b>0.32</b>	<b>0.33</b>	<b>0.33</b>	<b>0.40</b>

**5. Other Assets**

Particulars	As at 31st December 2021	As at 31st March 2021	As at 31st March 2020	As at 31st March 2019
<b>Non-current</b>				
Capital advances	18.50	22.32	4.46	27.46
<b>Total</b>	<b>18.50</b>	<b>22.32</b>	<b>4.46</b>	<b>27.46</b>
<b>Current</b>				
Advances to suppliers [Refer Note 5.1]	32.24	16.63	18.63	23.37
Balance with customs, central excise, GST and state authorities	159.40	112.35	139.05	226.61
Government grant - export incentives receivable	89.78	110.53	78.10	90.89
Prepaid expenses	41.01	36.68	29.89	33.88
Advance payments, other recoverable in cash or in kind-or for value to be received	2.92	0.63	0.24	0.96
Advance rent	2.98	3.27	7.06	4.27
Fund raising expenses	-	-	59.89	56.07
Insurance claim receivable	-	-	60.29	-
<b>Total</b>	<b>328.33</b>	<b>280.09</b>	<b>393.15</b>	<b>436.05</b>

5.1) No advances are due from directors or other officers of the Company, firms in which a director is a partner or private companies in which director is a director or a member either severally or jointly with any other person.

**Uniparts India Limited****Annexure V - Notes to the Restated Consolidated Financial Information****(All amounts are in Rs. million, unless stated otherwise)****6. Inventories**

<b>Particulars</b>	<b>As at 31st December 2021</b>	<b>As at 31st March 2021</b>	<b>As at 31st March 2020</b>	<b>As at 31st March 2019</b>
Raw materials (including materials in transit)	530.02	513.27	482.97	662.82
Work-in-progress	958.75	878.18	738.91	879.84
Finished goods (including goods at port)	2,861.61	1,771.19	2,060.58	1,858.15
Stores and spares (including materials in transit)	334.23	300.39	293.49	293.98
Scrap	9.19	7.13	5.96	7.55
<b>Sub-Total</b>	<b>4,693.80</b>	<b>3,470.16</b>	<b>3,581.91</b>	<b>3,702.34</b>
Less: Provision for obsolescence	148.09	79.37	52.74	27.68
<b>Total</b>	<b>4,545.71</b>	<b>3,390.79</b>	<b>3,529.17</b>	<b>3,674.66</b>

During the period/year ended 31st December 2021, 31st March 2021, 31st March 2020, 31st March 2019 in addition to above provision for obsolescence, Rs. 130.57 million, Rs. 161.13 million, Rs. 10.29 million and Rs. 19.41 million respectively was recognised as an expense for inventories carried at net realisable value.

**Uniparts India Limited**  
**Annexure V - Notes to the Restated Consolidated Financial Information**  
**(All amounts are in Rs. million, unless stated otherwise)**

**7. Investments**

Particulars	As at 31st December 2021	As at 31st March 2021	As at 31st March 2020	As at 31st March 2019
<b>Current</b>				
<b>Investments at fair value through profit or loss (FVTPL)</b>				
Investment in mutual fund (quoted funds)	17.58	12.50	-	-
3405.302 units (31st March 2021: 2483.92 units, 31st March 2020: Nil, 31st March 2019: Nil) units of Nippon India Liquid Fund-G				
<b>Total</b>	<b>17.58</b>	<b>12.50</b>	<b>-</b>	<b>-</b>

**8. Trade Receivables**

Particulars	As at 31st December 2021	As at 31st March 2021	As at 31st March 2020	As at 31st March 2019
<b>Current (secured, considered good)</b>				
Trade receivables	5.97	5.93	4.73	9.11
<b>Sub-Total</b>	<b>5.97</b>	<b>5.93</b>	<b>4.73</b>	<b>9.11</b>
<b>Current (Unsecured, considered good)</b>				
Trade receivables	1,607.77	1,669.39	1,223.62	1,449.66
Credit impaired	1.25	2.14	8.49	0.95
<b>Sub-Total</b>	<b>1,609.02</b>	<b>1,671.53</b>	<b>1,232.11</b>	<b>1,450.61</b>
<b>Impairment allowance (bad and doubtful debts)</b>				
Expected credit loss	(1.25)	(2.14)	(8.49)	(6.14)
<b>Total</b>	<b>1,613.74</b>	<b>1,675.32</b>	<b>1,228.35</b>	<b>1,453.58</b>

8.1) Generally payment against sale of goods become due as per payment terms, and fixed transaction price as per contracts with customers.

8.2) The carrying amount of trade receivables includes receivables which are discounted with banks. Since the Company has retained the late payment and credit risk of these receivables, such receivables are not derecognised and a corresponding amount is recognised as borrowings [Refer note no. 13]. Amount so recognised is Rs. Nil for the period ended 31st December 2021, Rs. Nil for the year ended 31st March 2021, Rs. 42.65 millions for the year ended 31st March 2020 and Rs. 100.12 for the year ended 31st March 2019.

**Uniparts India Limited**  
**Annexure V - Notes to the Restated Consolidated Financial Information**  
**(All amounts are in Rs. million, unless stated otherwise)**

**Note Trade Receivables ageing schedule**

<b>Particulars</b>	<b>As at 31st December 2021</b>	<b>As at 31st March 2021</b>	<b>As at 31st March 2020</b>	<b>As at 31st March 2019</b>
<b>Less than 6 months</b>				
Undisputed Trade Receivables - considered good	1,611.61	1,673.61	1,225.69	1,444.96
Undisputed Trade Receivables - credit impaired	0.30	1.10	3.10	0.98
Undisputed Trade Receivables – which have significant increase in credit risk	-	-	-	-
Disputed Trade Receivables - considered good	-	-	-	-
Disputed Trade Receivables - credit impaired	-	-	-	-
Disputed Trade Receivables – which have significant increase in credit risk	-	-	-	-
<b>6 months - 1 year</b>				
Undisputed Trade Receivables - considered good	1.34	0.04	1.20	6.86
Undisputed Trade Receivables - credit impaired	-	0.01	2.38	1.78
Undisputed Trade Receivables – which have significant increase in credit risk	-	-	-	-
Disputed Trade Receivables - considered good	-	-	-	-
Disputed Trade Receivables - credit impaired	-	-	-	-
Disputed Trade Receivables – which have significant increase in credit risk	-	-	-	-
<b>1-2 Year</b>				
Undisputed Trade Receivables - considered good	0.40	0.80	1.20	1.00
Undisputed Trade Receivables - credit impaired	-	0.08	2.07	2.25
Undisputed Trade Receivables – which have significant increase in credit risk	-	-	-	-
Disputed Trade Receivables - considered good	-	-	-	-
Disputed Trade Receivables - credit impaired	-	-	-	-
Disputed Trade Receivables – which have significant increase in credit risk	-	-	-	-

**Uniparts India Limited**  
**Annexure V - Notes to the Restated Consolidated Financial Information**  
**(All amounts are in Rs. million, unless stated otherwise)**

<b>Particulars</b>	<b>As at 31st December 2021</b>	<b>As at 31st March 2021</b>	<b>As at 31st March 2020</b>	<b>As at 31st March 2019</b>
<b>2-3 Year</b>				
Undisputed Trade Receivables - considered good	0.32	0.87	0.00	0.43
Undisputed Trade Receivables - credit impaired	-	-	-	0.17
Undisputed Trade Receivables – which have significant increase in credit risk	-	-	-	-
Disputed Trade Receivables - considered good	-	-	-	-
Disputed Trade Receivables - credit impaired	-	-	-	-
Disputed Trade Receivables – which have significant increase in credit risk	-	-	-	-
<b>More than 3 Years</b>				
Undisputed Trade Receivables - considered good	0.07	-	0.25	0.34
Undisputed Trade Receivables - credit impaired	-	-	-	-
Undisputed Trade Receivables – which have significant increase in credit risk	-	-	-	-
Disputed Trade Receivables - considered good	-	-	-	-
Disputed Trade Receivables - credit impaired	0.95	0.95	0.95	0.95
Disputed Trade Receivables – which have significant increase in credit risk	-	-	-	-
<b>Total</b>	<b>1,614.99</b>	<b>1,677.46</b>	<b>1,236.84</b>	<b>1,459.72</b>

**Uniparts India Limited**  
**Annexure V - Notes to the Restated Consolidated Financial Information**  
**(All amounts are in Rs. million, unless stated otherwise)**

**9. Cash and Cash Equivalents**

Particulars	As at 31st December 2021	As at 31st March 2021	As at 31st March 2020	As at 31st March 2019
Cash on hand	0.84	1.00	1.94	3.28
<b>Balances with banks:</b>				
In cash credit and current accounts	128.67	106.64	166.11	75.09
In EEFC accounts	1.15	0.27	-	0.14
Deposits with original maturity of less than three months	1.07	0.27	1.16	-
<b>Total</b>	<b>131.73</b>	<b>108.18</b>	<b>169.21</b>	<b>78.51</b>
<b>Other bank balances</b>				
Deposits with original maturity of less than twelve months	-	-	0.35	72.42
<b>Total</b>	<b>-</b>	<b>-</b>	<b>0.35</b>	<b>72.42</b>

**10. Loans**

Particulars	As at 31st December 2021	As at 31st March 2021	As at 31st March 2020	As at 31st March 2019
<b>Current (Unsecured, considered good)</b>				
Loans to employees	3.77	3.44	1.70	4.90
<b>Total</b>	<b>3.77</b>	<b>3.44</b>	<b>1.70</b>	<b>4.90</b>

**Break up of financial assets carried at amortised cost**

Particulars	As at 31st December 2021	As at 31st March 2021	As at 31st March 2020	As at 31st March 2019
Other financial assets [Refer Note 4]	46.56	44.82	50.81	51.80
Trade receivables [Refer Note 8]	1,613.74	1,675.32	1,228.35	1,453.58
Cash and cash equivalents [Refer Note 9]	131.73	108.18	169.21	78.51
Other bank balances [Refer Note 9]	-	-	0.35	72.42
Loans [Refer Note 10]	3.77	3.44	1.70	4.90
<b>Total</b>	<b>1,795.80</b>	<b>1,831.76</b>	<b>1,450.42</b>	<b>1,661.21</b>

**Break up of financial assets carried at fair value through OCI**

Particulars	As at 31st December 2021	As at 31st March 2021	As at 31st March 2020	As at 31st March 2019
Derivative instruments	45.44	35.38	-	14.70
<b>Total</b>	<b>45.44</b>	<b>35.38</b>	<b>-</b>	<b>14.70</b>

**Break up of financial assets carried at FVTPL**

Particulars	As at 31st December 2021	As at 31st March 2021	As at 31st March 2020	As at 31st March 2019
Investments [Refer Note 7]	17.58	12.50	-	-
<b>Total</b>	<b>17.58</b>	<b>12.50</b>	<b>-</b>	<b>-</b>

**Uniparts India Limited**  
**Annexure V - Notes to the Restated Consolidated Financial Information**  
**(All amounts are in Rs. million, unless stated otherwise)**

**11. Equity share capital**

Particulars	As at 31st December 2021	As at 31st March 2021	As at 31st March 2020	As at 31st March 2019
<b>AUTHORISED</b>				
6,00,00,000 (31st March 2021 : 6,00,00,000, 31st March 2020 : 6,00,00,000, 31st March 2019 : 6,00,00,000) equity shares of Rs. 10 each	600.00	600.00	600.00	600.00
<b>ISSUED, SUBSCRIBED AND PAID-UP</b>				
4,51,33,758 (31st March 2021: 4,51,33,758, 31st March 2020 : 4,51,33,758, 31st March 2019 : 4,51,33,758) equity shares of Rs. 10 each fully Paid-up	451.34	451.34	451.34	451.34
Less: Amount recoverable from Uniparts Employees Stock Option Plan (ESOP) Trust	5.14	5.14	5.14	5.14
<b>Total</b>	<b>446.20</b>	<b>446.20</b>	<b>446.20</b>	<b>446.20</b>

**11(a) Reconciliation of equity shares outstanding at the beginning and at the end of the reporting period/year:**

Particulars	As at 31st December 2021		As at 31st March 2021		As at 31st March 2020		As at 31st March 2019	
	No. of Shares	Amount	No. of Shares	Amount	No. of Shares	Amount	No. of Shares	Amount
At the beginning of the period/year	4,51,33,758	451.34	4,51,33,758	451.34	4,51,33,758	451.34	4,51,33,758	451.34
Add: Issued during the period/year	-	-	-	-	-	-	-	-
<b>At the end of the year</b>	<b>4,51,33,758</b>	<b>451.34</b>	<b>4,51,33,758</b>	<b>451.34</b>	<b>4,51,33,758</b>	<b>451.34</b>	<b>4,51,33,758</b>	<b>451.34</b>

**11(b) Terms/ rights attached to equity shares**

The Company has only one class of equity shares having par value of Rs. 10 per share. Each holder of equity shares is entitled to one vote per share. The shareholders of equity shares of the Company are entitled to receive dividends as and when declared by the Company and enjoy proportionate voting rights in case any resolution is put to vote. In the event of liquidation of the Company, the holders of equity shares will be entitled to receive remaining assets of the Company, after distribution of all preferential amount, if any. The distribution will be in proportion to the number of equity shares held by the shareholders.



**Uniparts India Limited**

**Annexure V - Notes to the Restated Consolidated Financial Information**

(All amounts are in Rs. million, unless stated otherwise)

**11(c) Details of shareholders holding more than 5% shares:**

Name of Shareholders	As at 31st December 2021		As at 31st March 2021		As at 31st March 2020		As at 31st March 2019	
	No. of Shares	% holding in the class	No. of Shares	% holding in the class	No. of Shares	% holding in the class	No. of Shares	% holding in the class
Gurdeep Soni	89,95,090	19.93	89,95,090	19.93	1,49,55,570	33.14	1,49,55,570	33.14
Ashoka Investment	71,80,642	15.91	71,80,642	15.91	71,80,642	15.91	71,80,642	15.91
The Paramjit Soni 2018 CG-NG Nevada Trust (through Peak Trust Company-NV)	63,95,090	14.17	63,95,090	14.17	55,95,090	12.40	55,95,090	12.40
The Karan Soni 2018 CG-NG Nevada Trust (through Peak Trust Company-NV)	52,00,000	11.52	52,00,000	11.52	40,00,000	8.86	40,00,000	8.86
The Meher Soni 2018 CG-NG Nevada Trust (through Peak Trust Company-NV)	52,00,000	11.52	52,00,000	11.52	37,00,000	8.20	37,00,000	8.20
Pamela Soni	30,00,000	6.65	30,00,000	6.65	19,79,520	4.39	19,79,520	4.39
<b>Equity Shares at the end of the period/year</b>	<b>3,59,70,822</b>	<b>79.70</b>	<b>3,59,70,822</b>	<b>79.70</b>	<b>3,74,10,822</b>	<b>82.90</b>	<b>3,74,10,822</b>	<b>82.90</b>

**Uniparts India Limited**  
**Annexure V - Notes to the Restated Consolidated Financial Information**  
**(All amounts are in Rs. million, unless stated otherwise)**

**11(d) Aggregate number of bonus shares issued, shares issued for consideration other than cash during the period of five years immediately preceding the reporting date.**

The Company has during the financial year 2013-14, issued 22,566,879 equity shares as bonus shares in the ratio of 1:1, i.e. one equity share for every one existing share held in the Company which have been allotted on Apr 04, 2014.

**11(e) Disclosure of Shareholding of Promoters/ Promoters group**

Particulars	As at 31st December 2021			As at 31st March 2021			As at 31st March 2020			As at 31st March 2019		
	No. of Shares	% holding in the class	% Change	No. of Shares	% holding in the class	% Change	No. of Shares	% holding in the class	% Change	No. of Shares	% holding in the class	% Change
<b>Equity Share Capital</b>												
Gurdeep Soni	89,95,090	19.93	-	89,95,090	19.93	(13.21)	1,49,55,570	33.14	-	1,49,55,570	33.14	-
Paramjit Singh Soni	2,00,000	0.44	-	2,00,000	0.44	(1.77)	10,00,000	2.22	-	10,00,000	2.22	(12.40)
Meher Soni	-	-	-	-	-	(3.32)	15,00,000	3.32	-	15,00,000	3.32	(8.20)
Karan Soni	-	-	-	-	-	(2.66)	12,00,000	2.66	-	12,00,000	2.66	(8.86)
Pamela Soni	30,00,000	6.65	-	30,00,000	6.65	2.26	19,79,520	4.39	-	19,79,520	4.39	-
Angad Soni	20,00,000	4.43	-	20,00,000	4.43	4.32	50,000	0.11	-	50,000	0.11	-
Arjun Soni	20,00,000	4.43	-	20,00,000	4.43	4.41	10,000	0.02	-	10,000	0.02	-
Tanya Kohli	10,00,000	2.22	-	10,00,000	2.22	2.22	-	-	-	-	-	-
The Paramjit Soni 2018 CG-NG Nevada Trust (through Peak Trust Company-NV)	63,95,090	14.17	-	63,95,090	14.17	1.77	55,95,090	12.40	-	55,95,090	12.40	12.40
The Karan Soni 2018 CG-NG Nevada Trust (through Peak Trust Company-NV)	52,00,000	11.52	-	52,00,000	11.52	2.66	40,00,000	8.86	-	40,00,000	8.86	8.86
The Meher Soni 2018 CG-NG Nevada Trust (through Peak Trust Company-NV)	52,00,000	11.52	-	52,00,000	11.52	3.32	37,00,000	8.20	-	37,00,000	8.20	8.20
<b>Total</b>	<b>3,39,90,180</b>	<b>75.31</b>	<b>-</b>	<b>3,39,90,180</b>	<b>75.31</b>	<b>-</b>	<b>3,39,90,180</b>	<b>75.31</b>	<b>-</b>	<b>3,39,90,180</b>	<b>75.31</b>	<b>-</b>

**Uniparts India Limited**  
**Annexure V - Notes to the Restated Consolidated Financial Information**  
**(All amounts are in Rs. million, unless stated otherwise)**

**12. Other equity**

<b>Particulars</b>	<b>As at 31st December 2021</b>	<b>As at 31st March 2021</b>	<b>As at 31st March 2020</b>	<b>As at 31st March 2019</b>
<b>SECURITIES PREMIUM [Refer note 12.1]</b>				
As per last restated Balance Sheet	837.56	837.56	837.56	837.56
Add: Amount recognised during the period/year	0.43	-	-	-
	<b>837.99</b>	<b>837.56</b>	<b>837.56</b>	<b>837.56</b>
Less: Amount recoverable from Uniparts Employees Stock Option Plan (ESOP) Trust	48.25	48.25	48.25	48.25
	<b>789.74</b>	<b>789.31</b>	<b>789.31</b>	<b>789.31</b>
<b>EMPLOYEES STOCK OPTIONS OUTSTANDING [Refer note 12.2]</b>				
As per last restated Balance Sheet	40.02	35.99	30.14	28.15
Add: Compensation for the period/year [Refer Note 23]	7.85	4.03	5.85	1.99
Less: Transfer to Securities premium	0.43	-	-	-
	<b>47.44</b>	<b>40.02</b>	<b>35.99</b>	<b>30.14</b>
<b>FOREIGN CURRENCY TRANSLATION RESERVE [Refer note 12.3]</b>				
As per last restated Balance Sheet	(855.19)	(811.69)	(710.14)	(636.51)
Add: Transfer during the period/year	(14.83)	(43.50)	(99.67)	(75.51)
-Ind AS 116 transition adjustment (Refer Annexure VI - Summary of Restatement Adjustments)	-	-	(1.88)	1.88
	<b>(870.02)</b>	<b>(855.19)</b>	<b>(811.69)</b>	<b>(710.14)</b>
<b>CASH FLOW HEDGE RESERVE [Refer note 12.4]</b>				
As per last restated Balance Sheet	25.03	(42.22)	9.56	1.26
Add: Arising during the period/year	7.53	67.25	(51.78)	9.56
Less: Adjusted during the period/year	-	-	-	1.26
	<b>32.56</b>	<b>25.03</b>	<b>(42.22)</b>	<b>9.56</b>
<b>GENERAL RESERVE [Refer note 12.5]</b>				
As per last restated Balance Sheet	12.05	12.05	12.05	12.05
	<b>12.05</b>	<b>12.05</b>	<b>12.05</b>	<b>12.05</b>
<b>SPECIAL ECONOMIC ZONE RE-INVESTMENT RESERVE [Refer note 12.6]</b>				
As per last restated Balance Sheet	60.87	71.84	110.00	-
Add: Arising during the period/year	-	-	-	110.00
Less: Adjusted during the period/year	31.51	10.97	38.16	-
	<b>29.36</b>	<b>60.87</b>	<b>71.84</b>	<b>110.00</b>

**Uniparts India Limited**

**Annexure V - Notes to the Restated Consolidated Financial Information**

(All amounts are in Rs. million, unless stated otherwise)

<b>SURPLUS/(DEFICIT) IN THE STATEMENT OF PROFIT AND LOSS</b>				
As per last restated Balance Sheet	5,075.52	4,140.17	3,532.69	3,014.91
Ind AS 116 transition adjustment (Refer Annexure VI - Summary of Restatement Adjustments)	-	-	1.15	(8.05)
Earlier Year Tax Impact	-	-	-	1.36
Add: Restated profit for the period/year	1,223.36	923.86	626.42	695.97
Add: Transfer from Special Economic Zone re-investment reserve	31.51	10.97	38.16	-
<b>Add: Other Comprehensive Income:</b>				
Re-measurement of defined benefit obligations (net of tax) [Refer note 12.7]	(9.16)	0.52	7.04	(7.10)
	<b>6,321.23</b>	<b>5,075.52</b>	<b>4,205.46</b>	<b>3,697.09</b>
<b>Less: Appropriations</b>				
Payment of dividend on equity shares	148.94	-	54.16	45.13
Tax on dividend	-	-	21.79	16.97
Reversal of tax on dividend	-	-	(10.66)	(7.70)
Transfer to Special Economic Zone re-investment reserve	-	-	-	110.00
	<b>148.94</b>	<b>-</b>	<b>65.29</b>	<b>164.40</b>
	<b>6,172.29</b>	<b>5,075.52</b>	<b>4,140.17</b>	<b>3,532.69</b>
<b>Total</b>	<b>6,213.42</b>	<b>5,147.61</b>	<b>4,195.45</b>	<b>3,773.61</b>

**Uniparts India Limited**

**Annexure V - Notes to the Restated Consolidated Financial Information**

(All amounts are in Rs. million, unless stated otherwise)

**12(a) Distribution made and proposed to made**

Particulars	As at 31st December 2021	As at 31st March 2021	As at 31st March 2020	As at 31st March 2019
<b>Cash dividends on equity shares declared and paid</b>				
<b>Final cash dividend</b>				
For the period/year ended on 31st December 2021: Rs. 3.30 per share (31st March 2021: Rs. Nil per share, 31st March 2020 Rs. 1.20 per share, 31st March 2019 : Rs. 1.0 per share)				
	148.94	-	54.16	45.13
DDT on dividend	-	-	11.13	9.28
Reversal of dividend distribution tax	-	-	(10.66)	(7.70)
<b>Total Dividend</b>	<b>148.94</b>	<b>-</b>	<b>54.63</b>	<b>46.71</b>

Particulars	As at 31st December 2021	As at 31st March 2021	As at 31st March 2020	As at 31st March 2019
<b>Proposed dividend on equity shares :</b>				
<b>Final dividend</b>				
For the period/year ended on 31st December 2021: Rs. 5.60 per share (31st March 2021: Rs. 3.30 per share, 31st March 2020 : Rs. Nil per share, 31st March 2019: Rs. 1.20 per share)				
	252.75	148.94	-	54.16
DDT on proposed dividend	-	-	-	11.13
Reversal of dividend distribution tax	-	-	-	(10.66)
<b>Total Dividend</b>	<b>252.75</b>	<b>148.94</b>	<b>-</b>	<b>54.63</b>

The Board of Directors of the Company in their meeting held on 1st March 2022 , has approved for payment of interim dividend for the financial year 2021-22. Accordingly, the Company has not recorded as a liability as at 31st December 2021.

The Board of Directors of the Company in their meeting held on 27th July 2021 and 20th May 2019, has approved for payment of final dividend for the year ended 31st March 2021 and 31st March 2019 respectively. Accordingly, the Company has not recorded as a liability as at 31st March 2021 and 31st March 2019.

12.1 Securities premium account is used to record the premium on issue of equity shares. The same is utilised in accordance with the provisions of The Companies Act, 2013

12.2 The Share option outstanding account is to be utilised for the purpose of issuance of Equity shares under Employee Stock Option Plan.

12.3 Foreign currency translation reserve comprises exchange difference on translation of foreign operations.

12.4 Cash flow hedge reserve represents the effective portion of fair value of derivative financial instruments designated as hedging instruments.

12.5 Retained earnings and General Reserve are to be utilised for General purpose.

12.6 The Special Economic Zone Re-investment Reserve has been created out of the profit of eligible SEZ units in terms of the provisions of Sec 10AA(1)(ii) of Income Tax Act,1961. The reserve should be utilized by the Company up to March 31, 2022 for acquiring new plant and machinery for the purpose of its business in the terms of the Sec 10AA(2) of the Income Tax Act, 1961.

12.7 Remeasurements of defined benefit obligations comprises of actuarial gains and losses

**Uniparts India Limited**  
**Annexure V - Notes to the Restated Consolidated Financial Information**  
**(All amounts are in Rs. million, unless stated otherwise)**

**13. Borrowings**

<b>Particulars</b>	<b>As at 31st December 2021</b>	<b>As at 31st March 2021</b>	<b>As at 31st March 2020</b>	<b>As at 31st March 2019</b>
<b>Non-current borrowings</b>				
Foreign currency term loans from bank (secured) [Refer Note 13(a)]	14.99	23.49	53.94	178.77
Other foreign currency loans [Refer Note 13(a)]	0.15	0.35	-	0.80
Rupee term loans from bank (secured) [Refer Note 13(a)]	-	33.33	162.18	295.58
<b>Total</b>	<b>15.14</b>	<b>57.17</b>	<b>216.12</b>	<b>475.15</b>
<b>Current borrowings</b>				
<b>Current maturity of term loans from banks</b>				
Foreign currency term loans (secured)	13.16	29.12	102.73	109.18
Rupee term loans (secured)	45.83	50.00	86.73	54.26
<b>Current maturity of term loans from others</b>				
Foreign currency term loans (secured)	0.12	0.14	0.79	0.58
Rupee term loans (secured)	-	-	-	0.36
<b>Working capital loans from banks repayable on demand</b>				
<b>Foreign currency loans</b>				
Preshipment packing credit (secured) [Refer note 13(a)]	1,065.17	911.85	1,524.46	1,544.02
Revolving Credit Facility/Lines of Credit [Refer note 13(a)]	270.16	177.58	591.49	891.20
<b>Rupee loans</b>				
Preshipment packing credit (secured) [Refer note 13(a)]	-	50.36	-	281.41
Working Capital Demand Loan (secured) [Refer note 13(a)]	-	1.55	-	-
Bill discounting with banks (unsecured) [Refer note 13(a)]	-	-	42.65	100.12
<b>Total</b>	<b>1,394.44</b>	<b>1,220.60</b>	<b>2,348.85</b>	<b>2,981.13</b>

The quarterly returns/statements of current assets filed by the Group with banks or financial institutions in relation to secured borrowings wherever applicable, are in agreement with the books of accounts and there are no material differences required to be reported.

Uniparts India Limited

Annexure V - Notes to the Restated Consolidated Financial Information

(All amounts are in Rs. million, unless stated otherwise)

13(a) Details of Borrowings

S.No.	Nature of Loan	Name of Borrower	Name of Lender	Rate of Interest	Terms of Repayment	Terms of Loan & Securities	Principal O/S. As at 31st December 2021	Principal O/S. As at 31st March 2021	Principal O/S. As at 31st March 2020	Principal O/S. As at 31st March 2019
1.	Term loan (Foreign currency)	Uniparts India Limited	Kotak Mahindra Bank Limited	4% ~ 5% p.a on outstanding USD notional, monthly.	Moratorium of 6 months from the date of drawdown and repayable in 36 equal monthly instalment	Loan is secured against: (i) First pari-passu charge on all existing and future moveable fixed assets excluding vehicle specifically financed by other lenders of the borrowers, (ii) Equitable mortgage charge over two properties, including land and building belonging to the borrowers situated at C140, Focal point, Ludhiana and plot no. D 126A, focal point Ludhiana, (iii) Personal guarantees/securities of (a) Mr. Gurdeep Soni (KMP) and (b) Mr. Paramjit Singh Soni (KMP) (Upto 2nd December 2020), Directors of the Company.	-	12.53	90.42	154.20
2	Term loan (Foreign currency)	Uniparts Olsen Inc.	JP Morgan Chase	4.49% ~ 4.85% p.m.	Repayable with fixed monthly payments of Rs. 0.64 million through March, 2021, Rs. 0.55 million through March, 2022, Rs. 0.47 million through March 2023 and Rs. 0.94 million through April 2024.	Loan is secured by: (i) Substantially all assets of Uniparts Olsen Inc. and (ii) Corporate Guarantee of Uniparts USA Ltd.	28.15	40.08	65.73	88.50

Uniparts India Limited

Annexure V - Notes to the Restated Consolidated Financial Information

(All amounts are in Rs. million, unless stated otherwise)

13(a) Details of Borrowings

S.No.	Nature of Loan	Name of Borrower	Name of Lender	Rate of Interest	Terms of Repayment	Terms of Loan & Securities	Principal O/S. As at 31st December 2021	Principal O/S. As at 31st March 2021	Principal O/S. As at 31st March 2020	Principal O/S. As at 31st March 2019
3	Term loan (Foreign currency)	Uniparts USA Limited	JP Morgan Chase	2.25% plus an adjusted LIBOR.	Repayable with fixed monthly payments of Rs. 0.45 million through March 24, 2020.	Loan is secured by: (i) Substantially all assets of the Uniparts USA Ltd. and (ii) Corporate Guarantee of Uniparts Olsen Inc.	-	-	-	45.25
4	Term loan (Foreign currency)	Uniparts USA Limited	Wells Fargo Equipment Finance	5.29%	Repayable with fixed monthly payments of Rs. 0.06 million through June, 2021.	Loan is secured by equipment financed	-	0.14	0.86	1.38
5	Term loan (Foreign currency)	Uniparts USA Limited	BMW Financial Service NA LLC	3.99%	Repayable with fixed monthly payments of Rs. 0.01 million.	Loan is secured against hypothecation of vehicle financed	0.27	0.35	0.47	-
6	Term loan (Indian Rupee)	Uniparts India Limited	Kotak Mahindra Bank Limited	8% ~ 9.5% p.a.	Moratorium of 6 months from the date of drawdown and repayable in 54 equal monthly instalment	Loan is secured against: (i) First pari-passu charge on all existing and future moveable fixed assets excluding vehicle specifically financed by other lenders of the borrowers, (ii) Equitable mortgage charge over two properties, including land and building belonging to the borrowers situated at C140, Focal point, Ludhiana and plot no. D 126A, focal point Ludhiana, (iii) Personal guarantees of Mr. Gurdeep Soni (KMP).	-	-	115.47	149.75
7	Term loan (Indian Rupee)	Uniparts India Limited	Citibank N.A.	5.22% ~ 9.13% p.a.	Moratorium of 12 months from the date of drawdown and repayable in 48 equal monthly instalments	Loan is secured against: (i) Exclusive charge on the moveable fixed assets funded from the term loan. (ii) Plant and machinery and corporate guarantee of Gripwel Fasteners Pvt. Ltd.	45.83	83.33	133.33	200.00



Uniparts India Limited

Annexure V - Notes to the Restated Consolidated Financial Information

(All amounts are in Rs. million, unless stated otherwise)

13(a) Details of Borrowings

S.No.	Nature of Loan	Name of Borrower	Name of Lender	Rate of Interest	Terms of Repayment	Terms of Loan & Securities	Principal O/S. As at 31st December 2021	Principal O/S. As at 31st March 2021	Principal O/S. As at 31st March 2020	Principal O/S. As at 31st March 2019
8	Term loan (Indian Rupee)	Gripwel Fasteners Private Limited	Axis Bank Limited	9.75% p.a	Repayable within 36 months from the date of sanction	Loan is secured against hypothecation of Car	-	-	0.09	0.09
9	Term loan (Indian Rupee)	Uniparts India Limited	Kotak Mahindra Prime Limited	9.99% p.a	Repayable within 5 years from the date of sanction	Loan is secured against hypothecation of Car	-	-	-	0.36
10	Preshipment packing credit (Foreign currency)	Uniparts India Limited	Kotak Mahindra Bank Limited	3% ~ 4% p.a.	Repayable on Demand or within 180 Days	Loan is secured against: (i) First pari passu charge on all existing and future current assets and moveable fixed assets, (ii) Equitable mortgage by way of first pari passu charge over the land and building situated at B208, A1&2, Phase II, Noida, UP and (iii) Personal guarantees/securities of (a) Mr. Gurdeep Soni (KMP) (Upto 5th October 2021) and (b) Mr. Paramjit Singh Soni (KMP) (Upto 2nd December 2020), Directors of the Company.	222.46	93.59	276.76	332.27
11	Preshipment packing credit (Foreign currency)	Uniparts India Limited	Citibank N.A.	3% ~ 4% p.a.	Repayable on Demand or within 180 Days	Loan is secured against: (i) First pari passu charge on all existing and future current assets and moveable fixed assets, (ii) Equitable mortgage by way of first pari passu charge over the land and building situated at B208, A1&2, Phase II, Noida, UP and (iii) Personal guarantees/securities of (a) Mr. Gurdeep Soni (KMP) (Upto 17th March 2021) and (b) Mr. Paramjit Singh Soni (KMP) (Upto 17th March 2021), Directors of the Company.	507.97	515.83	600.80	691.92

Uniparts India Limited

Annexure V - Notes to the Restated Consolidated Financial Information

(All amounts are in Rs. million, unless stated otherwise)

13(a) Details of Borrowings

S.No.	Nature of Loan	Name of Borrower	Name of Lender	Rate of Interest	Terms of Repayment	Terms of Loan & Securities	Principal O/S. As at 31st December 2021	Principal O/S. As at 31st March 2021	Principal O/S. As at 31st March 2020	Principal O/S. As at 31st March 2019
12	Preshipment packing credit (Foreign currency)	Uniparts India Limited	DBS Bank India Limited	3% ~ 4% p.a.	Repayable on Demand or within 180 Days	Loan is secured against: (i) First pari passu charge on all existing and future current assets and moveable fixed assets, (ii) Equitable mortgage by way of first pari passu charge over the land and building situated at B208, A1&2, Phase II, Noida, UP and (iii) Personal guarantees/securities of (a) Mr. Gurdeep Soni (KMP) (Upto 21st September 2021) and (b) Mr. Paramjit Singh Soni (KMP) (Upto 21st September 2021), Directors of the Company.	277.61	198.70	351.10	399.45
13	Preshipment packing credit (Foreign currency)	Uniparts India Limited	RBL Bank Limited	3% ~ 4% p.a.	Repayable on Demand or within 180 Days	Loan is secured against: (i) First pari passu charge on all existing and future current assets and moveable fixed assets, (ii) Equitable mortgage by way of first pari passu charge over the land and building situated at B208, A1&2, Phase II, Noida, UP and (iii) Personal guarantees/securities of (a) Mr. Gurdeep Soni (KMP) (Upto 2nd March 2021) and (b) Mr. Paramjit Singh Soni (KMP) (Upto 2nd March 2021), Directors of the Company.	57.13	103.73	117.68	13.84

Uniparts India Limited

Annexure V - Notes to the Restated Consolidated Financial Information

(All amounts are in Rs. million, unless stated otherwise)

13(a) Details of Borrowings

S.No.	Nature of Loan	Name of Borrower	Name of Lender	Rate of Interest	Terms of Repayment	Terms of Loan & Securities	Principal O/S. As at 31st December 2021	Principal O/S. As at 31st March 2021	Principal O/S. As at 31st March 2020	Principal O/S. As at 31st March 2019
14	Preshipment packing credit (Indian Rupee)	Uniparts India Limited	RBL Bank Limited	5% ~ 9.5% p.a.	Repayable on Demand or within 180 Days	Loan is secured against: (i) First pari passu charge on all existing and future current assets and moveable fixed assets, (ii) Equitable mortgage by way of first pari passu charge over the land and building situated at B208, A1&2, Phase II, Noida, UP and (iii) Personal guarantees/securities of (a) Mr. Gurdeep Soni (KMP) (Upto 2nd March 2021) and (b) Mr. Paramjit Singh Soni (KMP) (Upto 2nd March 2021), Directors of the Company.	-	-	-	181.40
15	Preshipment packing credit (Indian Rupee)	Uniparts India Limited	Kotak Mahindra Bank Limited	5% ~ 9.5% p.a.	Repayable on Demand or within 180 Days	Loan is secured against: (i) First pari passu charge on all existing and future current assets and moveable fixed assets, (ii) Equitable mortgage by way of first pari passu charge over the land and building situated at B208, A1&2, Phase II, Noida, UP and (iii) Personal guarantees/securities of (a) Mr. Gurdeep Soni (KMP) (Upto 5th October 2021) and (b) Mr. Paramjit Singh Soni (KMP) (Upto 2nd December 2020), Directors of the Company.	-	10.36	-	-

Uniparts India Limited

Annexure V - Notes to the Restated Consolidated Financial Information

(All amounts are in Rs. million, unless stated otherwise)

13(a) Details of Borrowings

S.No.	Nature of Loan	Name of Borrower	Name of Lender	Rate of Interest	Terms of Repayment	Terms of Loan & Securities	Principal O/S. As at 31st December 2021	Principal O/S. As at 31st March 2021	Principal O/S. As at 31st March 2020	Principal O/S. As at 31st March 2019
16	Preshipment packing credit (Indian Rupee)	Uniparts India Limited	DBS Bank India Limited	5% ~ 9.5% p.a.	Repayable on Demand or within 180 Days	Loan is secured against: (i) First pari passu charge on all existing and future current assets and moveable fixed assets, (ii) Equitable mortgage by way of first pari passu charge over the land and building situated at B208, A1&2, Phase II, Noida, UP and (iii) Personal guarantees/securities of (a) Mr. Gurdeep Soni (KMP) (Upto 21st September 2021) and (b) Mr. Paramjit Singh Soni (KMP) (Upto 21st September 2021), Directors of the Company.	-	40.00	-	
17	Preshipment packing credit (Foreign currency)	Gripwel Fasteners Private Limited	Citibank N.A.	3% ~ 4% p.a.	Repayable on Demand or within 180 Days	Loan is secured against: (i) First exclusive charge on present and future stocks and book debts of the company, (ii) First exclusive charge by way of equitable mortgage on land and building located at 142A/30 to 142A/51, NSEZ, Noida, UP and (iii) Corporate Guarantees of Holding Company i.e. Uniparts India Limited.	-	-	178.11	106.55
18	Preshipment packing credit (Indian Rupee)	Gripwel Fasteners Private Limited	Citibank N.A.	5% ~ 9.5% p.a.	Repayable on Demand or within 180 Days	Loan is secured against: (i) First exclusive charge on present and future stocks and book debts of the company, (ii) First exclusive charge by way of equitable mortgage on land and building located at 142A/30 to 142A/51, NSEZ, Noida, UP and (iii) Corporate Guarantees of Holding Company i.e. Uniparts India Limited.	-	-	-	100.00

**Uniparts India Limited**

**Annexure V - Notes to the Restated Consolidated Financial Information**

(All amounts are in Rs. million, unless stated otherwise)

**13(a) Details of Borrowings**

S.No.	Nature of Loan	Name of Borrower	Name of Lender	Rate of Interest	Terms of Repayment	Terms of Loan & Securities	Principal O/S. As at 31st December 2021	Principal O/S. As at 31st March 2021	Principal O/S. As at 31st March 2020	Principal O/S. As at 31st March 2019
19	Revolving Credit Facility (Foreign Currency)	Uniparts Olsen Inc.	J.P. Morgan Chase	LIBOR + 100 bps to 175 bps	Repayable on Demand or within 365 Days	The Loan collateralised by substantially all asset of Uniparts Olsen Inc., cross collateralised with the term loan at the bank. This line is secured by a corporate guarantee by Uniparts USA Ltd.	143.53	23.96	361.70	479.52
20	Revolving Credit Facility (Foreign Currency)	Uniparts USA Limited	J.P. Morgan Chase	LIBOR + 100 bps to 175 bps	Repayable on Demand or within 365 Days	The Loan collateralised by substantially all asset of Uniparts USA Ltd., cross collateralised with the term loan at the bank. This line is secured by a corporate guarantee by Uniparts Olsen Inc.	126.63	153.62	229.79	411.68
21	Working Capital Demand Loan	Uniparts India Limited	Citibank N.A.	5% ~ 9.5% p.a.	Repayable within 1 year	Loan is secured against: (i) First pari passu charge on all existing and future current assets and moveable fixed assets, (ii) Equitable mortgage by way of first pari passu charge over the land and building situated at B208, A1&2, Phase II, Noida, UP and (iii) Personal guarantees/securities of (a) Mr. Gurdeep Soni (KMP) (Upto 17th March 2021) and (b) Mr. Paramjit Singh Soni (KMP) (Upto 17th March 2021), Directors of the Company.	-	1.55	-	-
22	Bill discounting	Uniparts India Limited	Citibank N.A.	9% ~ 9.5%	Repayable within 120 days	Unsecured facility	-	-	42.65	100.12

**Uniparts India Limited**  
**Annexure V - Notes to the Restated Consolidated Financial Information**  
**(All amounts are in Rs. million, unless stated otherwise)**

**14. Lease liabilities**

<b>Particulars</b>	<b>As at 31st December 2021</b>	<b>As at 31st March 2021</b>	<b>As at 31st March 2020</b>	<b>As at 31st March 2019</b>
<b>Non Current</b>				
Lease liabilities	249.30	278.57	346.62	389.54
<b>Total</b>	<b>249.30</b>	<b>278.57</b>	<b>346.62</b>	<b>389.54</b>
<b>Current</b>				
Lease liabilities	52.53	65.32	72.42	73.39
<b>Total</b>	<b>52.53</b>	<b>65.32</b>	<b>72.42</b>	<b>73.39</b>

**15. Provisions**

<b>Particulars</b>	<b>As at 31st December 2021</b>	<b>As at 31st March 2021</b>	<b>As at 31st March 2020</b>	<b>As at 31st March 2019</b>
<b>Non Current</b>				
Provision for gratuity [Refer Note 32]	137.04	133.15	118.55	112.98
Provision for leave entitlement [Refer Note 32]	24.88	22.97	19.70	20.85
<b>Total</b>	<b>161.92</b>	<b>156.12</b>	<b>138.25</b>	<b>133.83</b>
<b>Current</b>				
Provision for gratuity [Refer Note 32]	36.60	36.03	37.34	42.25
Provision for leave entitlement [Refer Note 32]	15.30	18.70	25.73	22.62
<b>Total</b>	<b>51.90</b>	<b>54.73</b>	<b>63.07</b>	<b>64.87</b>

**16. Deferred tax liabilities (net)**

<b>Particulars</b>	<b>As at 31st December 2021</b>	<b>As at 31st March 2021</b>	<b>As at 31st March 2020</b>	<b>As at 31st March 2019</b>
Deferred tax assets	73.88	72.71	82.52	123.85
Deferred tax liabilities	316.35	348.32	324.00	397.40
<b>Total</b>	<b>242.47</b>	<b>275.61</b>	<b>241.48</b>	<b>273.55</b>

**Uniparts India Limited**  
**Annexure V - Notes to the Restated Consolidated Financial Information**  
**(All amounts are in Rs. million, unless stated otherwise)**

Particulars	As at 31st March 2021	Recognised in Profit and Loss account	Recognised in Other Comprehensive Income	Others Including exchange difference	As at 31st December 2021
<b>Period ended 31st December 2021</b>					
<b>Deferred tax assets</b>					
Expenses deductible in future years	50.23	2.73	3.08	-	56.04
Lease Liabilities	22.48	(4.64)	-	-	17.84
	<b>72.71</b>	<b>(1.91)</b>	<b>3.08</b>	<b>-</b>	<b>73.88</b>
<b>Deferred tax liabilities</b>					
Property, plant and equipment and intangible assets	169.73	(31.32)	-	-	138.41
Fair valuation of Cash flow hedges	8.91	-	2.53	-	11.44
<b>On account of Overseas Subsidiaries</b>					
Deferred tax liabilities	169.69	(6.42)	-	3.24	166.51
	<b>348.32</b>	<b>(37.74)</b>	<b>2.53</b>	<b>3.24</b>	<b>316.35</b>
<b>Total</b>	<b>275.61</b>	<b>(35.83)</b>	<b>(0.55)</b>	<b>3.24</b>	<b>242.47</b>

Particulars	As at 31st March 2020	Recognised in Profit and Loss account	Recognised in Other Comprehensive Income	Others Including exchange difference	As at 31st March 2021
<b>Year ended 31st March 2021</b>					
<b>Deferred tax assets</b>					
Expenses deductible in future years	53.38	(2.97)	(0.17)	-	50.23
Lease liabilities	29.14	(6.66)	-	-	22.48
	<b>82.52</b>	<b>(9.63)</b>	<b>(0.17)</b>	<b>-</b>	<b>72.71</b>
<b>Deferred tax liabilities</b>					
Property, plant and equipment and intangible assets	187.95	(18.23)	-	-	169.73
Fair valuation of Cash flow hedges	(13.71)	-	22.62	-	8.91
<b>On account of Overseas Subsidiaries</b>					
Deferred tax liabilities	149.76	24.79	-	(4.87)	169.69
	<b>324.00</b>	<b>6.56</b>	<b>22.62</b>	<b>(4.87)</b>	<b>348.32</b>
<b>Total</b>	<b>241.48</b>	<b>16.20</b>	<b>22.79</b>	<b>(4.87)</b>	<b>275.61</b>

**Uniparts India Limited**  
**Annexure V - Notes to the Restated Consolidated Financial Information**  
**(All amounts are in Rs. million, unless stated otherwise)**

Particulars	As at 31st March 2019	Recognised in Profit and Loss account	Recognised in Other Comprehensive Income	Others Including exchange difference	As at 31st March 2020
<b>Year ended 31st March 2020</b>					
<b>Deferred tax assets</b>					
Expenses deductible in future years	71.77	(15.98)	(2.41)	-	53.38
Lease liabilities	52.08	(21.67)	-	(1.27)	29.14
	<b>123.85</b>	<b>(37.65)</b>	<b>(2.41)</b>	<b>(1.27)</b>	<b>82.52</b>
<b>Deferred tax liabilities</b>					
Property, plant and equipment and intangible assets	265.61	(76.22)	-	(1.44)	187.95
Fair valuation of Cash flow hedges	5.14	(1.44)	(17.41)	-	(13.71)
<b>On account of Overseas Subsidiaries</b>					
Deferred tax liabilities	126.65	11.03	-	12.08	149.76
	<b>397.40</b>	<b>(66.63)</b>	<b>(17.41)</b>	<b>10.64</b>	<b>324.00</b>
<b>Total</b>	<b>273.55</b>	<b>(28.98)</b>	<b>(15.00)</b>	<b>11.91</b>	<b>241.48</b>

Particulars	As at 31st March 2018	Recognised in Profit and Loss account	Recognised in Other Comprehensive Income	Others Including exchange difference	As at 31st March 2019
<b>Year ended 31st March 2019</b>					
<b>Deferred tax assets</b>					
Expenses deductible in future years	62.23	6.04	3.50	-	71.77
Ind AS 116 transition adjustment (Refer Annexure VI - Summary of Restatement Adjustments)	-	(10.70)	-	62.78	52.08
	<b>62.23</b>	<b>(4.66)</b>	<b>3.50</b>	<b>62.78</b>	<b>123.85</b>
<b>Deferred tax liabilities</b>					
Property, plant and equipment and intangible assets	200.02	5.73	-	59.86	265.61
Fair valuation of Cash flow hedges	0.67	(0.67)	5.14	-	5.14
<b>On account of Overseas Subsidiaries</b>					
Deferred tax liabilities	110.03	10.69	-	5.93	126.65
	<b>310.72</b>	<b>15.75</b>	<b>5.14</b>	<b>65.79</b>	<b>397.40</b>
<b>Total</b>	<b>248.49</b>	<b>20.41</b>	<b>1.64</b>	<b>3.01</b>	<b>273.55</b>



**Uniparts India Limited**  
**Annexure V - Notes to the Restated Consolidated Financial Information**  
**(All amounts are in Rs. million, unless stated otherwise)**

**17. Other liabilities**

<b>Particulars</b>	<b>As at 31st December 2021</b>	<b>As at 31st March 2021</b>	<b>As at 31st March 2020</b>	<b>As at 31st March 2019</b>
<b>Non Current</b>				
Deferred Rent	7.34	6.42	5.54	-
Deferred gain-leaseback	-	-	-	1.95
Deferred government grant [Refer Note 17.1]	2.59	2.89	3.28	3.68
<b>Total</b>	<b>9.93</b>	<b>9.31</b>	<b>8.82</b>	<b>5.63</b>
<b>Current</b>				
Trade deposits and advances [Refer Note 17.2]	10.42	1.62	0.86	1.42
Provision for expenses	149.41	101.94	107.18	65.29
Employee benefits payable	97.22	125.07	103.04	145.32
Temporary overdraft from banks	1.30	8.77	34.59	16.37
Statutory dues payable	27.63	33.12	23.91	33.96
Advance received from Insurance Co.	-	-	51.29	-
Deferred government grant[Refer Note 17.1]	0.26	0.26	0.26	0.26
<b>Total</b>	<b>286.24</b>	<b>270.78</b>	<b>321.13</b>	<b>262.62</b>

17.1 Government grants include grants and subsidies for investments in fixed assets. There are no unfulfilled conditions or contingencies attached to these grants.

17.2 Recognised as revenue upon satisfaction of performance obligation in immediate next reporting period.

**18. Trade payables**

<b>Particulars</b>	<b>As at 31st December 2021</b>	<b>As at 31st March 2021</b>	<b>As at 31st March 2020</b>	<b>As at 31st March 2019</b>
<b>Trade payables</b>				
Total outstanding dues of Micro Enterprises and Small Enterprises	391.97	380.06	146.36	125.90
Total outstanding dues of creditors other than Micro Enterprises and Small Enterprises	468.67	520.86	380.45	572.46
<b>Total</b>	<b>860.64</b>	<b>900.92</b>	<b>526.81</b>	<b>698.36</b>

**Uniparts India Limited**  
**Annexure V - Notes to the Restated Consolidated Financial Information**  
**(All amounts are in Rs. million, unless stated otherwise)**

**Notes:**

**Trade Payables ageing schedule**

<b>Particulars</b>	<b>As at 31st December 2021</b>	<b>As at 31st March 2021</b>	<b>As at 31st March 2020</b>	<b>As at 31st March 2019</b>
<b>Less than 1 Year</b>				
-MSME	391.97	380.06	146.37	125.91
-Others	463.70	515.23	371.48	563.78
<b>1-2 Year</b>				
-MSME	-	-	-	-
-Others	0.36	2.19	6.14	7.51
<b>2-3 Year</b>				
-MSME	-	-	-	-
-Others	3.60	2.47	1.52	0.53
<b>More than 3 Years</b>				
-MSME	-	-	-	-
-Others	1.01	0.97	1.30	0.63
<b>Total</b>	<b>860.64</b>	<b>900.92</b>	<b>526.81</b>	<b>698.36</b>

There are no disputed trade payables.

**Break up of financial liabilities carried at amortised cost**

<b>Particulars</b>	<b>As at 31st December 2021</b>	<b>As at 31st March 2021</b>	<b>As at 31st March 2020</b>	<b>As at 31st March 2019</b>
Non-current borrowings [Refer Note 13]	15.14	57.17	216.12	475.15
Current borrowings [Refer Note 13]	1,394.44	1,220.60	2,348.85	2,981.13
Lease liabilities [Refer Note 14]	301.83	343.89	419.04	462.93
Trade payables [Refer Note 18]	860.64	900.92	526.81	698.36
<b>Total</b>	<b>2,572.05</b>	<b>2,522.58</b>	<b>3,510.82</b>	<b>4,617.57</b>

**Break up of financial liability carried at fair value through OCI**

<b>Particulars</b>	<b>As at 31st December 2021</b>	<b>As at 31st March 2021</b>	<b>As at 31st March 2020</b>	<b>As at 31st March 2019</b>
Derivative instruments	-	-	54.49	-
<b>Total</b>	<b>-</b>	<b>-</b>	<b>54.49</b>	<b>-</b>

**Uniparts India Limited**  
**Annexure V - Notes to the Restated Consolidated Financial Information**  
**(All amounts are in Rs. million, unless stated otherwise)**

**19. Revenue from operations**

Particulars	For the period ended 31st December 2021	For the year ended 31st March 2021	For the year ended 31st March 2020	For the year ended 31st March 2019
<b>Revenue from contract with customers</b>				
<b>Sale of products</b>				
Finished goods (Net of returns, rebate etc.) [Refer Note 34]	8,445.96	8,688.64	8,726.09	10,169.45
Scrap	307.51	224.78	163.91	230.23
<b>Sale of services</b>				
Sale of services	-	-	17.36	-
	<b>8,753.47</b>	<b>8,913.42</b>	<b>8,907.36</b>	<b>10,399.68</b>
<b>Other operating revenues</b>				
Export incentives	48.38	113.40	164.44	205.97
Amortisation of deferred govt grants	0.30	0.39	0.40	0.01
Revenue from Consignment sales	6.77	4.21	-	-
	<b>55.45</b>	<b>118.00</b>	<b>164.84</b>	<b>205.98</b>
<b>Total</b>	<b>8,808.92</b>	<b>9,031.42</b>	<b>9,072.20</b>	<b>10,605.66</b>

**20. Other income**

Particulars	For the period ended 31st December 2021	For the year ended 31st March 2021	For the year ended 31st March 2020	For the year ended 31st March 2019
<b>Interest Income</b>				
Interest	8.53	7.82	12.35	4.93
Net gain on investments carried at fair value through profit and loss	0.32	0.30	-	-
<b>Others</b>				
Net gain on fair valuation of financial instruments (FVTPL)	0.05	-	-	-
Rental income	-	2.02	-	-
Lease receipts	2.12	2.39	2.46	-
Insurance claim recoveries	0.01	249.82	231.79	-
Profit on sale of fixed assets (net)	-	-	62.69	0.20
Proceeds from Paycheck Protection Program [Refer Note 46]	-	160.87	-	-
Employee retention credit [Refer Note 47]	11.09	-	-	-
Other income ELDL grant	-	0.74	-	-
Miscellaneous receipts	10.85	21.51	6.89	13.99
<b>Total</b>	<b>32.97</b>	<b>445.47</b>	<b>316.18</b>	<b>19.12</b>

**Uniparts India Limited**  
**Annexure V - Notes to the Restated Consolidated Financial Information**  
**(All amounts are in Rs. million, unless stated otherwise)**

**21. Cost of materials consumed**

Particulars	For the period ended 31st December 2021	For the year ended 31st March 2021	For the year ended 31st March 2020	For the year ended 31st March 2019
Inventories at the beginning of the period/year	488.40	482.19	660.43	520.11
Add: Purchases	3,859.54	3,387.98	3,144.96	4,423.16
Less: Inventories at the end of the period/year	485.70	488.40	482.19	660.43
<b>Cost of materials consumed</b>	<b>3,862.24</b>	<b>3,381.77</b>	<b>3,323.20</b>	<b>4,282.84</b>

**22. Changes in inventories of finished goods, work-in-progress, stock-in-trade and scrap**

Particulars	For the period ended 31st December 2021	For the year ended 31st March 2021	For the year ended 31st March 2020	For the year ended 31st March 2019
(Increase)/decrease in stocks:				
Inventories at the end of the period/year				
Finished goods	2,758.81	1,724.01	2,011.79	1,833.32
Work-in-progress	955.17	870.86	731.38	872.92
Scrap	9.19	7.13	5.96	7.55
	<b>3,723.17</b>	<b>2,602.00</b>	<b>2,749.13</b>	<b>2,713.79</b>
Inventories at the beginning of the period/year				
Finished goods	1,724.01	2,011.79	1,833.32	1,298.70
Work-in-progress	870.86	731.38	872.92	848.36
Scrap	7.13	5.96	7.55	7.13
	<b>2,602.00</b>	<b>2,749.13</b>	<b>2,713.79</b>	<b>2,154.19</b>
<b>Total</b>	<b>(1,121.17)</b>	<b>147.13</b>	<b>(35.34)</b>	<b>(559.60)</b>

**23. Employee benefits expense**

Particulars	For the period ended 31st December 2021	For the year ended 31st March 2021	For the year ended 31st March 2020	For the year ended 31st March 2019
Salaries and wages [Refer Note 32]	1,477.05	1,724.46	1,982.96	2,063.35
Contribution to provident and other funds	53.26	62.47	64.31	63.88
Expense on employee stock option scheme [Refer Note 33]	7.85	4.03	5.85	1.99
Staff welfare expenses	67.70	63.52	64.50	88.20
<b>Total</b>	<b>1,605.86</b>	<b>1,854.48</b>	<b>2,117.62</b>	<b>2,217.42</b>

**Uniparts India Limited**  
**Annexure V - Notes to the Restated Consolidated Financial Information**  
**(All amounts are in Rs. million, unless stated otherwise)**

**24. Finance costs**

<b>Particulars</b>	<b>For the period ended 31st December 2021</b>	<b>For the year ended 31st March 2021</b>	<b>For the year ended 31st March 2020</b>	<b>For the year ended 31st March 2019</b>
Interest	22.83	53.61	135.99	147.76
Bill discounting charges	-	0.96	14.82	12.59
Interest on lease liabilities	11.59	18.20	20.03	10.70
<b>Other borrowing costs:</b>				
Bank charges	7.86	8.30	8.81	10.93
<b>Total</b>	<b>42.28</b>	<b>81.07</b>	<b>179.65</b>	<b>181.98</b>

**25. Depreciation and amortization expenses**

<b>Particulars</b>	<b>For the period ended 31st December 2021</b>	<b>For the year ended 31st March 2021</b>	<b>For the year ended 31st March 2020</b>	<b>For the year ended 31st March 2019</b>
Depreciation of tangible assets [Refer Note 3]	198.78	270.78	258.11	225.02
Depreciation of right-of-use of assets [Refer Note 3]	55.59	80.29	85.27	69.70
Amortization of intangible assets [Refer Note 3]	17.29	21.52	11.04	6.24
<b>Total</b>	<b>271.66</b>	<b>372.59</b>	<b>354.42</b>	<b>300.96</b>

**Uniparts India Limited**  
**Annexure V - Notes to the Restated Consolidated Financial Information**  
**(All amounts are in Rs. million, unless stated otherwise)**

**26. Other expenses**

<b>Particulars</b>	<b>For the period ended 31st December 2021</b>	<b>For the year ended 31st March 2021</b>	<b>For the year ended 31st March 2020</b>	<b>For the year ended 31st March 2019</b>
Stores, spares and tools consumed	546.75	506.37	516.93	675.26
Sub-contracting expenses	542.14	538.30	629.14	879.50
Power, fuel and water	354.61	333.39	342.50	376.73
Cartage, freight and forwarding	656.81	407.07	384.50	481.61
Air freight	81.07	131.23	33.38	224.91
Rent	31.34	47.06	71.54	74.44
Rates and taxes	23.07	25.34	32.64	36.82
Travelling and conveyance	10.76	6.61	51.53	49.73
Communication	9.54	16.12	15.94	16.97
Printing and stationery	5.60	5.97	6.64	9.56
Insurance	31.90	33.15	41.70	39.05
<b>Repairs and maintenance:</b>				
Building	28.71	29.67	32.46	33.57
Plant and machinery	97.19	105.85	117.89	107.68
Others	79.21	96.43	107.35	104.23
Office maintenance	18.95	22.06	21.69	21.29
Vehicle repairs and maintenance	6.92	8.84	14.20	12.70
Advertisement, publicity and sales promotion	4.50	1.56	8.15	9.58
Commission and discount	-	-	-	3.32
Legal and professional charges	36.98	51.73	51.38	43.47
Directors sitting fees	0.70	1.12	0.46	1.43
Director commission	-	-	0.30	0.60
Payment to auditors [Refer Note 26.1]	9.41	15.69	14.53	24.07
Exchange differences (net)	(110.15)	(66.38)	(32.71)	29.01
Bad debts	1.20	3.80	2.06	7.55
Allowances for doubtful trade receivables (expected credit loss allowance) [Refer Note 8]	(0.90)	-	3.40	-
Staff recruitments	3.00	1.38	1.42	5.14
Loss on sale of fixed assets (net)	0.93	8.23	-	-
Donation and charity	0.79	0.73	0.29	0.34
Contribution towards CSR [Refer Note 37]	8.61	7.60	8.00	8.00
Fixed assets written-off	-	0.84	0.73	3.97
Loss due to fire	-	75.25	218.34	-
Miscellaneous	1.84	3.36	8.42	5.11
Fund raising Expenses written-off	-	35.88	-	-
<b>Total</b>	<b>2,481.48</b>	<b>2,454.25</b>	<b>2,704.80</b>	<b>3,285.64</b>

**Uniparts India Limited**  
**Annexure V - Notes to the Restated Consolidated Financial Information**  
**(All amounts are in Rs. million, unless stated otherwise)**

**26.1 Payment to Auditors**

<b>Particulars</b>	<b>For the period ended 31st December 2021</b>	<b>For the year ended 31st March 2021</b>	<b>For the year ended 31st March 2020</b>	<b>For the year ended 31st March 2019</b>
<b>As Auditors:</b>				
Audit fees	8.78	15.18	13.41	23.29
Tax Audit fee	-	0.07	0.07	0.07
GST Audit fee	-	0.10	-	-
<b>In Other Capacity:</b>				
Taxation Matters	-	0.04	0.04	0.04
Out of pocket expenses	0.63	0.30	1.02	0.67
<b>Total</b>	<b>9.41</b>	<b>15.69</b>	<b>14.54</b>	<b>24.07</b>

**27. Tax expenses**

<b>Particulars</b>	<b>For the period ended 31st December 2021</b>	<b>For the year ended 31st March 2021</b>	<b>For the year ended 31st March 2020</b>	<b>For the year ended 31st March 2019</b>
Current tax	512.01	245.54	127.53	203.76
MAT	-	-	19.06	(4.60)
Deferred tax	(35.83)	16.20	(28.98)	20.41
<b>Income tax expenses reported in the statement of profit and loss</b>	<b>476.18</b>	<b>261.74</b>	<b>117.61</b>	<b>219.57</b>

**Uniparts India Limited**  
**Annexure V - Notes to the Restated Consolidated Financial Information**  
**(All amounts are in Rs. million, unless stated otherwise)**

**Reconciliation of tax expenses and the accounting profit multiplied by the applicable tax rate**

Particulars	For the period ended 31st December 2021	For the year ended 31st March 2021	For the year ended 31st March 2020	For the year ended 31st March 2019
Accounting profit before tax from operations	1,699.54	1,185.60	744.03	915.54
Applicable Tax Rate	25.168%	25.168%	34.944%	34.944%
Income tax expense calculated at applicable tax rate	427.75	298.39	259.99	319.93
<b>Items giving rise to difference in tax</b>				
Exemption/Deduction u/s 10	-	-	(18.11)	(51.52)
Deductions u/s 80	(12.61)	(26.33)	(1.26)	(1.59)
Expenses disallowed	31.31	20.63	4.45	(9.74)
OCI Adjustments	-	-	-	(2.80)
MAT	-	-	0.93	7.50
Ind AS 116 transition adjustment (Refer Annexure VI - Summary of Restatement Adjustments)	-	-	-	1.70
Others	-	(1.02)	0.87	0.11
Differential Tax Rate under various jurisdiction for Subsidiaries Companies	65.56	(46.13)	(100.28)	(59.83)
<b>Current Tax Provision</b>	<b>512.01</b>	<b>245.54</b>	<b>146.59</b>	<b>203.76</b>
Incremental deferred tax liability on Account of timing difference	(37.74)	6.56	(66.63)	15.75
Incremental deferred tax Assets on Account of timing difference	(1.91)	(9.63)	(37.65)	(4.66)
<b>Deferred Tax Provision</b>	<b>(35.83)</b>	<b>16.20</b>	<b>(28.98)</b>	<b>20.41</b>
Total tax expenses recognised	476.18	261.74	117.61	224.17
Effective tax rate	28.02%	22.08%	15.81%	24.49%

**Uniparts India Limited**

The tax rate used for reconciliation is the Corporate Tax Rate of 25.168% for the period ended 31st December 2021 (31st March 2021: 25.168%, 31st March 2020: 34.944%, 31st March 2019 34.944%) payable by corporate entities in India on taxable profit under Indian Law. Company has adopted lower tax rate under section 115BAA of Income Tax Act, 1961 inserted vide Taxation Laws (amendment) Act, 2019 for the year/period ended 31st March 2021 and 31st December 2021.

**Gripwel Fasteners Private Limited**

The tax rate used for reconciliation is the Corporate Tax Rate of 25.168% for the period ended 31st December 2021 (31st March 2021: 25.168%, 31st March 2020: 25.168%, 31st March 2019 29.12%) payable by corporate entities in India on taxable profit under Indian Law. Company has adopted lower tax rate under section 115BAA of Income Tax Act, 1961 inserted vide Taxation Laws (amendment) Act, 2019 for the year/period ended 31st March 2020, 31st March 2021 and 31st December 2021.



**Uniparts India Limited**  
**Annexure V - Notes to the Restated Consolidated Financial Information**  
**(All amounts are in Rs. million, unless stated otherwise)**

**28. Earning Per Equity Share of Face Value of Rs. 10 Each**

Basic EPS amounts are calculated by dividing the profit for the year attributable to equity share holders of the parent by the weighted average number of equity shares outstanding during the year.

Diluted EPS amounts are calculated by dividing the profit attributable to equity holders of the parent by the weighted average number of equity shares outstanding during the year plus the weighted average number of equity shares that would be issued on conversion of all the dilutive potential equity shares into equity shares.

The following reflects the income and share data used in the basic and diluted EPS computations:

Particulars	For the period ended 31st December 2021	For the year ended 31st March 2021	For the year ended 31st March 2020	For the year ended 31st March 2019
<b>Computation of Profit (Numerator)</b>				
Net Profit after Tax as per the Statement of Profit & Loss attributable to Equity Shareholders	1,223.36	923.86	626.42	695.97
<b>Computation of Weighted Average Number of Shares (Denominator)</b>				
Adjusted Weighted Average number of Equity Shares for calculating Diluted EPS (In Millions)	45.13	45.13	45.13	45.13
Less: Shares Issued to Uniparts ESOP Trust (In Millions)	1.02	1.03	1.03	1.03
<b>Adjusted Weighted Average number of Equity Shares for calculating Basic EPS (In Millions)</b>	<b>44.11</b>	<b>44.10</b>	<b>44.10</b>	<b>44.10</b>
<b>Computation of EPS - Basic (in Rs.)</b>	<b>27.73</b>	<b>20.95</b>	<b>14.20</b>	<b>15.78</b>
<b>Computation of EPS - Diluted (in Rs.)</b>	<b>27.11</b>	<b>20.47</b>	<b>13.88</b>	<b>15.42</b>

**29. Components of other comprehensive income (OCI)**

Period ended 31st December 2021

Particulars	Effective portion of cash flow hedge	Retained earnings	Foreign operations translation differences	Income tax/ Deferred tax	Total
Re-measurement gains / (losses) of defined benefit plans	-	(12.24)	-	3.08	<b>(9.16)</b>
Exchange differences in translating the financial statements of foreign operations	-	-	(14.83)	-	<b>(14.83)</b>
Effective portion of cash flow hedge	10.06	-	-	(2.53)	<b>7.53</b>
<b>Total</b>	<b>10.06</b>	<b>(12.24)</b>	<b>(14.83)</b>	<b>0.55</b>	<b>(16.46)</b>

**Uniparts India Limited**  
**Annexure V - Notes to the Restated Consolidated Financial Information**  
**(All amounts are in Rs. million, unless stated otherwise)**

**Year ended 31st March 2021**

<b>Particulars</b>	<b>Effective portion of cash flow hedge</b>	<b>Retained earnings</b>	<b>Foreign operations translation differences</b>	<b>Income tax/ Deferred tax</b>	<b>Total</b>
Re-measurement gains / (losses) of defined benefit plans	-	0.69	-	(0.17)	<b>0.52</b>
Exchange differences in translating the financial statements of foreign operations	-	-	(43.50)	-	<b>(43.50)</b>
Effective portion of cash flow hedge	89.87	-	-	(22.62)	<b>67.25</b>
<b>Total</b>	<b>89.87</b>	<b>0.69</b>	<b>(43.50)</b>	<b>(22.79)</b>	<b>24.27</b>

**Year ended 31st March 2020**

<b>Particulars</b>	<b>Effective portion of cash flow hedge</b>	<b>Retained earnings</b>	<b>Foreign operations translation differences</b>	<b>Income tax/ Deferred tax</b>	<b>Total</b>
Re-measurement gains / (losses) of defined benefit plans	-	9.45	-	(2.41)	<b>7.04</b>
Exchange differences in translating the financial statements of foreign operations	-	-	(101.55)	-	<b>(101.55)</b>
Effective portion of cash flow hedge	(69.19)	-	-	17.41	<b>(51.78)</b>
<b>Total</b>	<b>(69.19)</b>	<b>9.45</b>	<b>(101.55)</b>	<b>15.00</b>	<b>(146.29)</b>

**Year ended 31st March 2019**

<b>Particulars</b>	<b>Effective portion of cash flow hedge</b>	<b>Retained earnings</b>	<b>Foreign operations translation differences</b>	<b>Income tax/ Deferred tax</b>	<b>Total</b>
Re-measurement gains / (losses) of defined benefit plans	-	(10.60)	-	3.50	<b>(7.10)</b>
Exchange differences in translating the financial statements of foreign operations	-	-	(73.63)	-	<b>(73.63)</b>
Effective portion of cash flow hedge	14.70	-	-	(5.14)	<b>9.56</b>
<b>Total</b>	<b>14.70</b>	<b>(10.60)</b>	<b>(73.63)</b>	<b>(1.64)</b>	<b>(71.17)</b>

**Uniparts India Limited**  
**Annexure V - Notes to the Restated Consolidated Financial Information**  
**(All amounts are in Rs. million, unless stated otherwise)**

**30 Contingent Liabilities and Commitments (To the Extent Not Provided For)**

Particulars	For the period ended 31st December 2021	For the year ended 31st March, 2021	For the year ended 31st March, 2020	For the year ended 31st March, 2019
<b>(i) Contingent liabilities:</b>				
<b>(a) Claims against the company not acknowledged as debt:</b>				
Sales Tax Matters	2.51	2.51	13.06	2.64
Service Tax Matters	-	-	-	0.23
Excise Matters	0.21	0.21	0.21	0.21
Custom Matters	-	1.60	1.60	1.60
GST Matters	0.36	0.36	0.36	-
Others	-	-	0.97	-
Labour Matters	Not Ascertainable	Not Ascertainable	Not Ascertainable	Not Ascertainable
<b>(b) Income Tax Demands</b>	59.74	78.65	44.42	9.72
<b>(c) Sales Tax Liability against Pending Forms</b>	-	0.36	0.36	0.04
<b>(d) Others</b>				
<b>a) Guarantees given on behalf of the company by the Banks:</b>				
Sales Tax Matters	0.03	0.03	0.03	0.03
Pollution Control Board	0.05	0.05	0.05	-
Excise Matters	-	-	0.50	0.50
Custom Matters	-	-	0.06	-
Gas Connections	2.68	2.68	2.68	2.68
<b>b) Other money for which the company is contingently liable:</b>				
SBLC (Stand By Letter of Credit) for Wholly Owned Subsidiaries	-	-	-	8.82
<b>(ii) Capital Commitments</b>				
Estimated amount of contracts remaining to be executed on Capital Accounts and not provided for (Net of Advances)	36.88	38.01	14.51	64.06

**31 Lease**

(i) Effective 1st April 2019, the Company adopted Ind AS 116 "Leases", applied to all lease contracts existing on 1st April 2019 using the modified retrospective method and has taken the cumulative adjustment to retained earnings as on the date of initial application. For the purpose of preparation of Restated Consolidated Financial Information, the Management has evaluated the impact of change in accounting policies on adoption of Ind AS 116 for the year ended 31st March 2019. Hence in these Restated Consolidated Financial Information, Ind AS 116 has been adopted with effect from 1st April 2018 following modified retrospective method (i.e. on 1st April 2018 the Group has measured the lease liability at the present value of the remaining lease payments, discounted using the lessee's incremental borrowing rate and right-of-use assets are measured at their carrying amount as if Ind AS 116 had been applied since the commencement date, discounted using the lessee's incremental borrowing rate at the date of initial application).

**Uniparts India Limited**  
**Annexure V - Notes to the Restated Consolidated Financial Information**  
**(All amounts are in Rs. million, unless stated otherwise)**

(ii) The following is the aggregate movement in lease liabilities:

Particulars	For the period	For the year	For the year	For the year
	ended	ended	ended	ended
	31st December 2021	31st March, 2021	31st March, 2020	31st March, 2019
Opening Balance	343.89	419.04	462.93	227.87
Ind AS 116 transition adjustment (Refer Annexure VI - Summary of Restatement Adjustments)	-	-	(10.14)	-
Additions during the year	2.63	6.58	5.81	294.49
Deletion during the year	-	(3.27)	-	-
Finance cost accrued during the year	11.59	18.20	20.03	10.70
Payment of lease liabilities	(60.75)	(88.69)	(84.66)	(68.98)
Exchange differences in translating the financial statements of foreign operations	4.47	(7.97)	25.07	(1.15)
<b>Closing Balance</b>	<b>301.83</b>	<b>343.89</b>	<b>419.04</b>	<b>462.93</b>

(iii) The following is the break-up of current and non-current lease liabilities:

Particulars	For the period	For the year	For the year	For the year
	ended	ended	ended	ended
	31st December 2021	31st March, 2021	31st March, 2020	31st March, 2019
Current lease liabilities	52.53	65.32	72.42	73.39
Non-current lease liabilities	249.30	278.57	346.62	389.54
<b>Total</b>	<b>301.83</b>	<b>343.89</b>	<b>419.04</b>	<b>462.93</b>

(iv) Lease commitments are the undiscounted future cash out flows from the lease contracts which are not recorded in the measurement of lease liabilities. These include potential future payments related to leases with term less than twelve months and leases of low value assets.

Particulars	For the period	For the year	For the year	For the year
	ended	ended	ended	ended
	31st December 2021	31st March, 2021	31st March, 2020	31st March, 2019
Payable within one year	52.53	65.32	72.42	73.39
Payable between one to five years	163.72	176.65	207.09	226.19
Payable after five years	85.58	101.92	139.53	163.35
<b>Total</b>	<b>301.83</b>	<b>343.89</b>	<b>419.04</b>	<b>462.93</b>

**Uniparts India Limited****Annexure V - Notes to the Restated Consolidated Financial Information****(All amounts are in Rs. million, unless stated otherwise)****32. Disclosure on Employee Benefits**

Disclosure is hereby given in pursuant to Ind AS19 "Employee Benefits".

**Defined Benefit Plan - Gratuity (Funded)**

The following table summarises the components of net benefit expense recognised in the statement of profit and loss and the funded status and amounts recognised in the balance sheet for the gratuity plan.

The principal assumptions used in determining gratuity for the Company's plan is shown below:

Particulars	For the period	For the year	For the year	For the year
	ended	ended	ended	ended
	31st December 2021	31st March 2021	31st March 2020	31st March 2019
Expected Rate of Return on Plan Assets	7.02%	6.33%	6.59%	7.48%
Discounting Rate of Uniparts India Limited	7.02%	6.33%	6.59%	7.48%
Discounting Rate of Gripwel Fasteners Private Limited	6.62%	6.49%	6.24%	7.48%
<b>UIL</b>				
Salary Escalation rate- Staff	8.00%	7.00%	7.94%	7.00%
Salary Escalation rate- Worker	8.00%	7.00%	6.00%	8.00%
Rate of Employee Turnover- Staff	10.00%	8.00%	20.00%	11.40%
Rate of Employee Turnover- Worker	1.00%	8.00%	8.00%	10.20%
<b>GFPL</b>				
Salary Escalation rate- Staff	8.00%	7.00%	7.94%	7.00%
Salary Escalation rate- Worker	8.00%	7.00%	6.00%	8.00%
Rate of Employee Turnover- Staff	10.00%	8.00%	20.00%	11.40%
Rate of Employee Turnover- Worker	1.00%	8.00%	8.00%	10.20%
Mortality Rate During Employment	Indian Assured Lives Mortality 2012-14 (Urban)	Indian Assured Lives Mortality(2006-08)	Indian Assured Lives Mortality(2006-08)	Indian Assured Lives Mortality(2006-08)
Mortality Rate After Employment	N.A.	N.A.	N.A.	N.A.

**Uniparts India Limited**

**Annexure V - Notes to the Restated Consolidated Financial Information**

(All amounts are in Rs. million, unless stated otherwise)

**Changes in the present value of the defined benefit obligation recognised in balance sheet are as follows:**

Particulars	For the period	For the year	For the year	For the year
	ended	ended	ended	ended
	31st December 2021	31st March 2021	31st March 2020	31st March 2019
Present value of defined benefit obligation as at the beginning of the period/year	193.23	176.36	174.65	145.26
Interest cost	9.22	11.50	12.97	11.14
Current service cost	11.98	14.31	16.20	14.18
Past Service Cost	-	-	-	-
Liability Transferred In/ Acquisitions	-	-	-	0.07
(Liability Transferred Out/ Divestments)	-	-	-	(0.07)
(Benefit Paid Directly by the Employer)	(7.83)	(10.48)	(17.61)	(6.71)
Actuarial (Gains)/Losses on Obligations - Due to Change in Demographic Assumptions	3.58	10.09	1.12	(2.93)
Actuarial (Gains)/Losses on Obligations - Due to Change in Financial Assumptions	6.64	(9.64)	(0.83)	7.28
Actuarial (Gains)/Losses on Obligations - Due to Experience	2.66	1.09	(10.14)	6.43
<b>Present Value of defined benefit obligation at the end of the period/year</b>	<b>219.48</b>	<b>193.23</b>	<b>176.36</b>	<b>174.65</b>

**Changes in the fair value of plan assets recognised in the balance sheet are as follows:**

Particulars	For the period	For the year	For the year	For the year
	ended	ended	ended	ended
	31st December 2021	31st March 2021	31st March 2020	31st March 2019
Opening fair value of plan assets	24.11	20.52	19.45	17.88
Interest Income	1.14	1.35	1.46	1.37
Contributions	20.00	-	-	-
Benefits paid	-	-	-	-
Return on plan assets, excluding amount recognized in Interest Income -Gain /(Loss)	0.64	2.24	(0.39)	0.20
<b>Closing fair value of plan assets</b>	<b>45.89</b>	<b>24.11</b>	<b>20.52</b>	<b>19.45</b>

**Uniparts India Limited**

**Annexure V - Notes to the Restated Consolidated Financial Information**

(All amounts are in Rs. million, unless stated otherwise)

**The amounts to be recognised in the Balance Sheet**

Particulars	For the period ended 31st December 2021	For the year ended 31st March 2021	For the year ended 31st March 2020	For the year ended 31st March 2019
Present value of obligation as at the end of the period/year	(219.48)	(193.23)	(176.36)	(174.65)
Fair value of plan assets as at the end of the period/year	45.88	24.10	20.51	19.45
<b>Funded Status (Surplus/ (Deficit))</b>	<b>(173.64)</b>	<b>(169.18)</b>	<b>(155.88)</b>	<b>(155.23)</b>
<b>Net asset / (liability) to be recognised in balance sheet</b>	<b>(173.64)</b>	<b>(169.18)</b>	<b>(155.88)</b>	<b>(155.23)</b>

**Net Interest cost (Income/Expense)**

Particulars	For the period ended 31st December 2021	For the year ended 31st March 2021	For the year ended 31st March 2020	For the year ended 31st March 2019
Present Value of Benefit Obligation at the Beginning of the period/year	193.23	176.36	174.65	145.26
(Fair Value of Plan Assets at the Beginning of the period/year)	(24.10)	(20.51)	(19.45)	(17.88)
<b>Net Liability/(Asset) at the Beginning</b>	<b>(169.18)</b>	<b>(155.88)</b>	<b>155.23</b>	<b>127.38</b>
Interest Cost	9.22	11.50	12.97	11.14
(Interest Income)	(1.14)	(1.35)	1.25	(1.37)
<b>Net Interest Cost for Current period/year</b>	<b>8.08</b>	<b>10.15</b>	<b>14.22</b>	<b>9.77</b>

**Expense recognised in the statement of profit and loss**

Particulars	For the period ended 31st December 2021	For the year ended 31st March 2021	For the year ended 31st March 2020	For the year ended 31st March 2019
Current service cost	11.98	14.31	16.20	14.18
Net Interest (Income) / Expense	8.07	10.15	14.22	9.77
Past Service Cost	-	-	-	-
<b>Net periodic benefit cost recognised in the statement of profit and loss</b>	<b>20.05</b>	<b>24.46</b>	<b>30.42</b>	<b>23.95</b>

**Amount recognised in Statement of Other Comprehensive Income (OCI)**

Particulars	For the period ended 31st December 2021	For the year ended 31st March 2021	For the year ended 31st March 2020	For the year ended 31st March 2019
Actuarial (Gains)/Losses on Obligation For the period/year	12.88	1.55	(9.84)	10.80
Return on Plan Assets, Excluding Interest Income	(0.64)	(2.24)	0.39	(0.20)
<b>Net (Income)/Expense For the year Recognized in OCI</b>	<b>12.24</b>	<b>(0.69)</b>	<b>(9.45)</b>	<b>10.60</b>

**Uniparts India Limited**

**Annexure V - Notes to the Restated Consolidated Financial Information**

(All amounts are in Rs. million, unless stated otherwise)

**Reconciliation of net Liability/(Asset) recognised:**

Particulars	For the period	For the year	For the year	For the year
	ended	ended	ended	ended
	31st December 2021	31st March 2021	31st March 2020	31st March 2019
Opening Net Liability	169.18	155.88	155.23	127.38
Expenses Recognized in Statement of Profit or Loss	20.05	24.46	27.73	23.95
Expenses Recognized in OCI	12.24	(0.70)	(9.45)	10.61
Net Liability/(Asset) Transfer In	0.35	-	-	0.07
Net (Liability)/Asset Transfer Out (Benefit Paid Directly by the Employer)	(0.35)	-	-	(0.07)
(Employer's Contribution)	(7.83)	(10.48)	(17.61)	(6.71)
	(20.00)	-	-	-
<b>Net Liability/(Asset) For the year Recognized in Balance Sheet</b>	<b>173.64</b>	<b>169.18</b>	<b>155.88</b>	<b>155.23</b>

**The major categories of plan assets are as follows:**

Particulars	For the period	For the year	For the year	For the year
	ended	ended	ended	ended
	31st December 2021	31st March 2021	31st March 2020	31st March 2019
Insurance fund	45.88	24.10	20.51	19.45

**Other Details**

Particulars	For the period	For the year	For the year	For the year
	ended	ended	ended	ended
	31st December 2021	31st March 2021	31st March 2020	31st March 2019
No of Active Members	2,014	2,029	2,135	2,382
Per Month Salary For Active Members	34.90	33.45	34.94	39.29
Weighted Average Duration of the Projected Benefit Obligation	11.00	9.00	7.00	8.00
Average Expected Future Service	14.00	9.00	7.00	7.00
Projected Benefit Obligation (PBO)	219.52	193.28	176.39	155.23
Prescribed Contribution For next period (12 Months)	29.49	28.16	29.25	32.84

**Maturity Analysis of Projected Benefit Obligation: From the Fund**

Particulars	For the period	For the year	For the year	For the year
	ended	ended	ended	ended
	31st December 2021	31st March 2021	31st March 2020	31st March 2019
Projected Benefits Payable in Future Years From the Date of Reporting				
1st Following Year	13.01	16.09	20.39	14.98
2nd Following Year	10.54	11.44	18.66	14.48
3rd Following Year	9.78	13.43	16.48	15.08
4th Following Year	12.12	12.44	15.77	14.23
5th Following Year	11.24	13.89	13.73	15.22
Sum of Years 6 To 10	68.49	66.50	54.21	60.86
Sum of Years 11 and above	285.32	-	-	-



**Uniparts India Limited**

**Annexure V - Notes to the Restated Consolidated Financial Information**

(All amounts are in Rs. million, unless stated otherwise)

**Maturity Analysis of Projected Benefit Obligation: From the Employer**

Particulars	For the period	For the year	For the year	For the year
	ended	ended	ended	ended
	31st December 2021	31st March 2021	31st March 2020	31st March 2019
Projected Benefits Payable in Future Years From the Date of Reporting				
1st Following Year	7.11	7.87	8.09	9.41
2nd Following Year	2.85	2.67	5.13	3.61
3rd Following Year	3.43	3.48	4.43	4.57
4th Following Year	3.08	3.57	3.71	3.63
5th Following Year	3.54	3.42	3.70	3.28
Sum of Years 6 To 10	20.21	16.73	12.72	14.40
Sum of Years 11 and above	26.92	-	-	

**Sensitivity analysis**

**A) Impact of change in discount rate when base assumption is decreased/increased present value of obligation**

Particulars	For the period	For the year	For the year	For the year
	ended	ended	ended	ended
	31st December 2021	31st March 2021	31st March 2020	31st March 2019
Decrease by 1%	(18.07)	13.90	9.21	10.39
Increase by 1%	21.02	(12.27)	(8.27)	(9.29)
	<b>2.95</b>	<b>1.63</b>	<b>0.94</b>	<b>1.10</b>

**B) Impact of change in salary increase rate when base assumption is decreased/increased present value of**

Particulars	For the period	For the year	For the year	For the year
	ended	ended	ended	ended
	31st December 2021	31st March 2021	31st March 2020	31st March 2019
Decrease by 1%	20.03	(11.83)	(8.08)	(9.00)
Increase by 1%	(17.63)	13.08	8.80	9.83
	<b>2.40</b>	<b>1.25</b>	<b>0.72</b>	<b>0.83</b>

**C) Impact of change in withdrawal rate when base assumption is decreased/increased present value of obligation**

Particulars	For the period	For the year	For the year	For the year
	ended	ended	ended	ended
	31st December 2021	31st March 2021	31st March 2020	31st March 2019
Decrease by 1%	(1.47)	0.61	0.12	0.12
Increase by 1%	1.64	(0.57)	(0.13)	(0.12)
	<b>0.17</b>	<b>0.04</b>	<b>(0.01)</b>	<b>-</b>

Sensitivity analysis is an analysis which will give the movement in liability if the assumptions were not proved to be true on different count. This only signifies the change in the liability if the difference between assumed and the actual is not following the parameters of the sensitivity analysis.

Since investment is with insurance company, Assets are considered to be secured.

**Uniparts India Limited**

**Annexure V - Notes to the Restated Consolidated Financial Information**

(All amounts are in Rs. million, unless stated otherwise)

The following are the expected Interest cost for future year:

Particulars	For the period ended	For the year ended	For the year ended	For the year ended
	31st December 2021	31st March 2021	31st March 2020	31st March 2019
Present Value of Benefit Obligation at the End of the period/year	219.52	193.28	176.39	172.68
(Fair Value of Plan Assets at the End of the period/year)	(45.88)	(24.10)	(20.51)	(19.45)
Net Liability/(Asset) at the End of the period/year	173.64	169.18	155.88	153.23
Interest Cost	15.24	12.29	11.50	12.97
(Interest Income)	(3.22)	(1.53)	(1.35)	(1.46)
Net Interest Cost for Future Year	12.02	10.77	10.15	11.51

The following are the expected expenses to be recognised in the Statement of Profit or Loss for future Year:

Particulars	For the period ended	For the year ended	For the year ended	For the year ended
	31st December 2021	31st March 2021	31st March 2020	31st March 2019
Current Service Cost	18.23	15.96	14.31	16.20
Net Interest Cost	12.02	10.77	10.15	11.51
(Expected Contributions by the Employees)	-	-	-	-
Expenses Recognized	30.25	26.73	24.46	27.72

**Defined Benefit Plan - Leave Encashment (Unfunded)**

The leave obligations cover the Company's liability for sick and earned leaves. The Company does not have an unconditional right to defer settlement for the obligation shown as current provision balance above. However based on past experience, the Company does not expect all employees to take the full amount of accrued leave or require payment within the next 12 months, therefore based on the independent actuarial report, only a certain amount of provision has been presented as current and remaining as non-current. Amount for the period ended 31st December 2021 is Rs 6.95 million, for the year ended 31st March 2021 is Rs. 4.76 million, for the year ended 31st March 2020 is Rs. 9.46 million and for the year ended 31st March 2019 is Rs. 12.59 million has been recognised in the statement of profit and loss.

Particulars	For the period ended	For the year ended	For the year ended	For the year ended
	31st December 2021	31st March 2021	31st March 2020	31st March 2019
<b>Current</b>				
Compensated absences (unfunded)	15.30	18.70	25.73	22.62
<b>Non-Current</b>				
Compensated absences (unfunded)	24.88	22.97	19.70	20.85
<b>Total</b>	<b>40.18</b>	<b>41.67</b>	<b>45.43</b>	<b>43.47</b>

### **33. Disclosure on Employee Share Based Payment**

**Disclosure is hereby given in pursuant to Ind AS 102 "Share Based Payment".**

#### **(a) Scheme Details**

The Company's ESOP scheme "Uniparts Employees Stock Option Plan, 2007" is administered through an ESOP Trust, which subscribes to shares of the Company and holds them until issuance thereof based on vesting and exercise of options by employees. The scheme provides that subject to continued employment with the Company, specified employees of the Company and its subsidiaries are granted an option to acquire equity shares of the Company that may be exercised within a specified period. Each option comprises of one equity share which will vest on annual basis in equal proportion over a period of three years (except Grant-11 and Grant-14 which shall vest 100% on the expiry of 12 months from the grant date) and shall be capable of being exercised within a period of fifteen years from the date of the specified grant. Each option granted under the above plan entitles the holder to one equity share of the Company at an exercise price, which is approved by the Nomination and Remuneration Committee. The Company has provided an interest free loan amounting to Rs. 55.20 million to the Trust to subscribe to 3,50,400 Shares issued at Rs. 135 per share and right issue of 1,75,200 Shares at Rs. 45 per share. The ESOP Trust has since subscribed to the Company's shares. As per IND AS 102 "Share-based Payment" and the Guidance Note on Accounting for Employee Share Based payments issued by the Institute of Chartered Accountants of India, the amount of loan equivalent to the face value of securities subscribed Rs. 5.14 million has been deducted from share capital account and the balance part of the loan representing the amount of share premium paid for the shares subscribed Rs. 48.25 million has been deducted from the share premium account.

The balance of such loan as at 31st December 2021 is Rs. 53.39 million, as at 31st March 2021 is Rs. 53.39 million, as at 31st March 2020 is Rs. 53.39 million and as at 31st March 2019 is Rs. 53.39 million. The repayment of loan is primarily dependent upon the exercise of options by the employees, the price at which fresh or reissued options are granted and dividend income earned thereon till exercise of options. The Company believes that the options would be exercised by the employees and the ESOP Trust would be able to repay the loan based on the price received by the Trust there against. On that basis, the loan to the ESOP Trust is considered good of recovery.

As per the Scheme, the Company has granted 1,14,833 options @ Rs. 135/- per option (Grant – 1), 42,764 options @ Rs. 135/- per option (Grant – 2), 25,000 options @ Rs. 135/- per option (Grant – 3), 86,592 Right Issue @ Rs. 45/- per share, 28,912 options @ Rs. 105/- per option (Grant – 4), 26,209 options @ Rs. 105/- per option (Grant – 5), 28,825 options @ Rs. 105/- per option (Grant – 6), 11,255 options @ Rs. 105/- per option (Grant – 7), 5,000 options @ Rs. 105/- per option (Grant – 8), 21,465 options @ Rs. 105/- per option (Grant – 9), 324,637 Bonus Issue @ Rs. Nil per share, 35,102 options @ Rs. 52.50 per option (Grant – 10), 52,948 options @ Rs. 52.50 per option (Grant – 11), 292,500 options @ Rs. 52.50 per option (Grant – 12), 25,000 options @ Rs. 52.50 per option (Grant – 13), 102,948 options @ Rs. 52.50 per option (Grant – 14), 67,412 options @ Rs. 52.50 per option (Grant – 15) and 2,500 options @ Rs. 52.50 per option (Grant – 16) in accordance with the provisions of the Securities and Exchange Board of India (Share Based Employee Benefits) Regulations, 2014, to the selected employees of the Company. The method of settlement is by issue of equity shares to the selected employees who have accepted the option.

Period within which options will vest to the participants

Grant-1 to Grant-10 and Grant-12, Grant-13, Grant- 15 and Grant- 16

2 years from the date of Grant of Options 33%

3 years from the date of Grant of Options 33%

4 years from the date of Grant of Options 34%

Grant-11 & Grant-14

12 months from the date of Grant of Options 100%

**Uniparts India Limited****Annexure V - Notes to the Restated Consolidated Financial Information****(All amounts are in Rs. million, unless stated otherwise)****(b) Share Based Payment activity under Scheme 2007 is as follows**

Particulars	For the period	For the year	For the year	For the year
	ended 31st December 2021	ended 31st March 2021	ended 31st March 2020	ended 31st March 2019
Outstanding at the beginning of the period/year	9,61,488	9,61,488	9,36,488	6,43,988
Bonus Issue during the period/year	-	-	-	-
Granted during the period/year	69,912	1,02,948	25,000	2,92,500
Forfeited/Surrendered during the period/year	(4,200)	(1,02,948)	-	-
Exercised during the period/year	8,250	-	-	-
Outstanding at the end of the period/year	10,18,950	9,61,488	9,61,488	9,36,488
Vested and Exercisable at the end of the period/year	8,77,671	6,37,565	6,43,988	6,43,988

**Uniparts India Limited**  
**Annexure V - Notes to the Restated Consolidated Financial Information**  
**(All amounts are in Rs. million, unless stated otherwise)**

**(c) Share options outstanding at the end of the year**

<b>Option Details</b>			<b>(Amount in INR)</b>	
<b>Option Series</b>	<b>Option Grant date</b>	<b>Exercise price</b>	<b>Weighted average fair value of Options on the date of Grant</b>	
Grant-1	08-02-2007	135.00	96.45	
Grant-2	27-03-2008	135.00	114.02	
Grant-3	27-03-2009	135.00	70.45	
Right Issue	Right Issue	45.00	97.65	
Grant-4	25-03-2011	105.00	56.69	
Grant-5	03-03-2012	105.00	77.63	
Grant-6	12-01-2013	105.00	67.19	
Grant-7	25-09-2013	105.00	41.10	
Grant-8	23-12-2013	105.00	47.08	
Grant-9	15-02-2014	105.00	55.00	
Bonus Issue	Bonus issue	-	-	
Grant-10	23-08-2014	52.50	32.50	
Grant-11	30-06-2015	52.50	38.26	
Grant-12	23-11-2018	52.50	53.34	
Grant-13	07-08-2019	52.50	43.84	
Grant-14	05-11-2020	52.50	77.68	
Grant-15	27-07-2021	52.50	136.03	
Grant-16	29-10-2021	52.50	136.03	

**Options Outstanding**

<b>Option Series</b>	<b>As at 31st December 2021</b>	<b>As at 31st March 2021</b>	<b>As at 31st March 2020</b>	<b>As at 31st March 2019</b>
Grant-1	89,754	89,754	89,754	89,754
Grant-2	20,357	20,357	20,357	20,357
Grant-3	25,000	25,000	25,000	25,000
Right Issue	67,556	67,556	67,556	67,556
Grant-4	22,785	22,785	22,785	22,785
Grant-5	11,268	11,268	11,268	11,268
Grant-6	22,535	22,535	22,535	22,535
Grant-7	-	-	-	-
Grant-8	5,000	5,000	5,000	5,000
Grant-9	21,465	21,465	21,465	21,465
Bonus Issue	2,85,720	2,85,720	2,85,720	2,85,720
Grant-10	19,600	19,600	19,600	19,600
Grant-11	-	-	52,948	52,948
Grant-12	2,32,550	2,42,500	2,92,500	2,92,500
Grant-13	25,000	25,000	25,000	-
Grant-14	1,02,948	1,02,948	-	-
Grant-15	64,912	-	-	-
Grant-16	2,500	-	-	-
<b>Total</b>	<b>10,18,950</b>	<b>9,61,488</b>	<b>9,61,488</b>	<b>9,36,488</b>

**Uniparts India Limited**  
**Annexure V - Notes to the Restated Consolidated Financial Information**  
**(All amounts are in Rs. million, unless stated otherwise)**

**Remaining contractual life**

<b>Option Series</b>	<b>As at 31st December 2021</b>	<b>As at 31st March 2021</b>	<b>As at 31st March 2020</b>	<b>As at 31st March 2019</b>
Grant-1	-	-	-	-
Grant-2	-	-	-	-
Grant-3	-	-	-	-
Right Issue	-	-	-	-
Grant-4	-	-	-	-
Grant-5	-	-	-	-
Grant-6	-	-	-	-
Grant-7	-	-	-	-
Grant-8	-	-	-	-
Grant-9	-	-	-	-
Bonus Issue	-	-	-	-
Grant-10	-	-	-	-
Grant-11	-	-	-	-
Grant-12	0.90	1.65	2.65	3.65
Grant-13	1.58	2.33	3.33	-
Grant-14	-	0.58	-	-
Grant-15	2.58	-	-	-
Grant-16	2.83	-	-	-

The Company follows the Fair Market Value calculated on Black Scholes Method to account for compensation expenses arising from issuance of stock options to the employees.

**(d) Inputs in the model**

<b>Option Series</b>	<b>Grant 16</b>	<b>Grant 15</b>	<b>Grant 14</b>	<b>Grant 13</b>	<b>Grant 12</b>
Grant date share price	198.23	198.23	129.55	79.11	84.91
Exercise price	52.50	52.50	52.50	52.50	52.50
Expected volatility	48.30%	48.30%	50.30%	14.74%	14.83%
Option Life	4.00	4.00	2.00	8.50	8.00
Dividend yield	3.00%	3.00%	2.30%	0.93%	0.68%
Risk-free interest rate	5.26%	5.26%	4.19%	6.73%	7.92%

**(e) Compensation expenses arising on account of the share based payments**

<b>Particulars</b>	<b>For the period ended 31st December 2021</b>	<b>For the year ended 31st March 2021</b>	<b>For the year ended 31st March 2020</b>	<b>For the year ended 31st March 2019</b>
Expenses arising from equity – settled share-based payment transactions	7.85	4.03	5.85	1.99

**Uniparts India Limited**  
**Annexure V - Notes to the Restated Consolidated Financial Information**  
**(All amounts are in Rs. million, unless stated otherwise)**

**34. Segment Information**

The Company operates primarily in the business of manufacturing of Linkage Parts and Components for Off-Highway Vehicles.

Chief Operating Decision Maker (CODM), evaluates the company's performance, based on the analysis of the various performance indicators of the company, the Chief Operating Decision Maker (CODM) has decided that there is no reportable segment for the Company.

**(i) Revenue information based on location of the customers**

<b>Particulars</b>	<b>For the period ended 31st December 2021</b>	<b>For the year ended 31st March 2021</b>	<b>For the year ended 31st March 2020</b>	<b>For the year ended 31st March 2019</b>
<b>Information in respect of geographical areas</b>				
Segment revenue from external customers :				
Within India	1,578.18	1,658.07	1,318.18	1,545.18
Outside India (Excluding deemed export)	7,175.29	7,255.35	7,589.18	8,854.50
<b>Total</b>	<b>8,753.47</b>	<b>8,913.42</b>	<b>8,907.36</b>	<b>10,399.68</b>

The company disaggregate revenue from contracts with customers into categories that depict how the nature, amount, timing and uncertainty of revenue and cash flows are affected by economic factors. The following table illustrates the disaggregation disclosure by primary geographical market, major product line and timing of revenue recognition in accordance with Ind AS 115.

**Primary geographical markets**

<b>Particulars</b>	<b>For the period ended 31st December 2021</b>	<b>For the year ended 31st March 2021</b>	<b>For the year ended 31st March 2020</b>	<b>For the year ended 31st March 2019</b>
India	1,270.67	1,433.28	1,146.04	1,339.40
Japan	409.07	408.30	420.77	484.72
Europe	2,231.01	2,106.30	1,650.28	1,916.45
Asia Pacific	180.84	169.28	166.78	219.64
USA	4,080.77	4,349.15	5,189.85	5,959.74
Rest of the World	273.59	222.33	152.37	249.50
	<b>8,445.96</b>	<b>8,688.64</b>	<b>8,726.09</b>	<b>10,169.45</b>
Sale of Scrap	307.51	224.78	163.91	230.23
Sale of Service	-	-	17.36	-
<b>Total Revenue</b>	<b>8,753.47</b>	<b>8,913.42</b>	<b>8,907.36</b>	<b>10,399.68</b>

**Uniparts India Limited**  
**Annexure V - Notes to the Restated Consolidated Financial Information**  
**(All amounts are in Rs. million, unless stated otherwise)**

**Major Product line**

<b>Particulars</b>	<b>For the period ended 31st December 2021</b>	<b>For the year ended 31st March 2021</b>	<b>For the year ended 31st March 2020</b>	<b>For the year ended 31st March 2019</b>
3PL	4,904.95	5,066.55	4,279.64	5,032.10
PMP	3,201.70	3,397.26	4,323.06	4,966.97
PTO	90.32	82.14	64.48	94.67
FAB	87.35	84.08	77.18	69.34
HYD	4.59	7.87	6.66	12.11
Others	157.05	50.73	(24.92)	(5.73)
	<b>8,445.96</b>	<b>8,688.64</b>	<b>8,726.09</b>	<b>10,169.45</b>
Sale of Scrap	307.51	224.78	163.91	230.23
Sale of Service	-	-	17.36	-
<b>Total Revenue</b>	<b>8,753.47</b>	<b>8,913.42</b>	<b>8,907.36</b>	<b>10,399.68</b>

**(ii) Non-current Assets**

<b>Particulars</b>	<b>For the period ended 31st December 2021</b>	<b>For the year ended 31st March 2021</b>	<b>For the year ended 31st March 2020</b>	<b>For the year ended 31st March 2019</b>
Within India	2,362.71	2,358.66	2,539.50	2,683.42
Outside India	410.92	478.00	527.84	564.07
<b>Total</b>	<b>2,773.63</b>	<b>2,836.66</b>	<b>3,067.34</b>	<b>3,247.49</b>
Adjustments (Including Goodwill)	612.30	590.01	597.87	601.66
<b>Total Non- Current Assets</b>	<b>3,385.93</b>	<b>3,426.67</b>	<b>3,665.21</b>	<b>3,849.15</b>



**Uniparts India Limited****Annexure V - Notes to the Restated Consolidated Financial Information****(All amounts are in Rs. million, unless stated otherwise)****35. Details of Dues to Micro and Small Enterprises as Defined under Micro, Small and Medium Enterprises Development Act, 2006 (MSMED Act, 2006)**

The Ministry of Corporate Affairs has issued notification no.G.S.R 1022(E) dated October 11, 2018 which prescribes certain disclosures regarding amount payable to micro enterprises and small enterprises. Accordingly, the disclosure in respect of the amounts payable to such enterprises has been made in the financial statements based on the information received from the vendors. The necessary information in this regard has been given hereunder :-

Particulars	For the period ended 31st December 2021	For the year ended 31st March 2021	For the year ended 31st March 2020	For the year ended 31st March 2019
(i) The principal amount and the interest due thereon remaining unpaid to any supplier as at the end of each accounting year;				
Principal	391.97	380.06	146.36	125.90
Interest	0.08	0.28	0.41	0.17
(ii) The amount of interest paid by the buyer in terms of Section 16 of the Micro, Small and Medium Enterprises Development Act, 2006, (the Act) along with the amount of the payment made to the supplier beyond the appointed day during each accounting year	-	-	-	-
(iii) The amount of interest due and payable for the period of delay in making payment (which have been paid but beyond the appointed day during the year) but without adding the interest specified under the said Act	-	-	-	-
(iv) The amount of interest accrued and remaining unpaid at the end of each year	0.08	0.28	0.41	0.17
(v) The amount of further interest remaining due and payable even in the succeeding years, until such date when the interest dues as above are actually paid to the small enterprise.	-	0.02	0.04	-

**Uniparts India Limited**  
**Annexure V - Notes to the Restated Consolidated Financial Information**  
**(All amounts are in Rs. million, unless stated otherwise)**

**36. Government Grants**

Uniparts India Limited has availed tax and duty benefit in the nature of exemption from payment of Customs Duty, on its procurements with respect to Plant and Machinery. The said benefits were availed which entitled Uniparts India Limited to procure goods without payment of taxes and duties of amount for Rs. 3.55 million under Zero Duty EPCG Scheme.

In accordance with Ind AS 20 "Accounting for Government Grants and Disclosure of Government Assistance" Uniparts India Limited has grossed up the value of property, plant and equipment by the amount of tax and duty benefit availed considering the same as government grant. The amount of said government grant has been added to the value of property, plant and equipment with corresponding credit to deferred government grant, the amount of grant shall be amortized on a systematic basis in line with depreciation to be charged on property, plant and equipment.

Deferred government grant is disclosed in the financial statements as follows :

Particulars	For the period	For the year	For the year	For the year
	ended	ended	ended	ended
	31st December 2021	31st March 2021	31st March 2020	31st March 2019
Opening Balance	3.15	3.54	3.94	3.94
Grant recognized during the year	-	-	-	205.98
Less : Amount recognized in statement of profit and loss*	(0.30)	(0.40)	(0.40)	(205.98)
Closing Balance	<b>2.85</b>	<b>3.14</b>	<b>3.54</b>	<b>3.94</b>
Non-current portion	2.59	2.89	3.28	3.68
Current portion	0.26	0.26	0.26	0.26

\*There is no unfulfilled condition or contingencies attached to these grants.

**Uniparts India Limited**

**Annexure V - Notes to the Restated Consolidated Financial Information**

(All amounts are in Rs. million, unless stated otherwise)

**37. Corporate social responsibility**

As per Section 135 of the Companies Act, 2013, CSR committees has been formed by the Parent Company and Subsidiary - Gripwel Fasteners Private Limited. The proposed areas for CSR activities, as per the CSR policy of the both Companies are promotion of education and/or health care, educational facilities for poor and needy and development of health facilities, medical aid to poor, needy and economically weaker section which are specified in Schedule VII of the Companies Act, 2013.

Particulars	For the period ended 31st December 2021	For the year ended 31st March 2021	For the year ended 31st March 2020	For the year ended 31st March 2019
<b>Details of Corporate social responsibility expenditure</b>				
(i) Gross amount required to be spent during the period/year	8.57	7.53	7.72	7.65
(ii) Amount spent during the period/year (in cash)				
-Construction/acquisition of any asset		-	-	-
-On purposes other than above	4.50	7.60	8.00	8.00
(iii) (Shortfall) / Excess at the end of the period/year	(4.07)	0.07	0.28	0.35
(iv) Total of previous years shortfall	-	-	-	-
(v) Details of related party transactions	Not applicable	Not applicable	Not applicable	Not applicable
(vi) Where a provision is made with respect to a liability incurred by entering into a contractual obligation, the movements in the provision during the year/period should be shown separately	Not applicable	Not applicable	Not applicable	Not applicable
(vii) Reason for shortfall:	Not applicable, being amount is required to be spent on or before 31st March 2022	Not applicable	Not applicable	Not applicable
(viii) Nature of CSR activities				
1. Promotion of education and/or health care				
2. Educational facilities for poor and needy				
3. Development of Health Facilities, Medical Aid to poor, needy and economically weaker section				

**Uniparts India Limited**  
**Annexure V - Notes to the Restated Consolidated Financial Information**  
**(All amounts are in Rs. million, unless stated otherwise)**

**38. Related Party Disclosure**

(i) Name of the related parties, related party relationship and related party with whom transactions have been taken place during the period/year.

**(A) Related parties where control exists**

**(a) Subsidiaries**

Name of the company	Country of Incorporation	% of voting power held as at 31st December 2021	% of voting power held as at 31st March 2021	% of voting power held as at 31st March 2020	% of voting power held as at 31st March 2019
Uniparts USA Limited	USA	100.00	100.00	100.00	100.00
Uniparts Europe BV	Netherlands	100.00	100.00	100.00	100.00
Gripwel Fasteners Private Limited	India	100.00	100.00	100.00	100.00
Uniparts India GmbH	Germany	100.00	100.00	100.00	100.00
Gripwel Conag Private Limited*	India	100.00	NA	NA	NA

\* Gripwel Conag Private Limited was incorporated on 6th December 2021 as 100% Subsidiary of Uniparts India Limited. However, the payment against the shares subscribed was yet to be made as on the reporting date.

**(b) Step down Subsidiaries**

Name of the company	Country of Incorporation	% of voting power held as at 31st December 2021	% of voting power held as at 31st March 2021	% of voting power held as at 31st March 2020	% of voting power held as at 31st March 2019
Uniparts Olsen Inc.	USA	100.00	100.00	100.00	100.00

**(B) Enterprises over which Key Managerial Personnel and their relatives exercise significant influence:**

SKG Engineering Pvt. Ltd.  
Sweaty Spirit Apparel Ltd. (Formerly known as Ace Tractor Parts Ltd.)  
SGA Trading Pvt. Ltd.  
Tima Trading Pvt. Ltd.  
Amazing Estates Pvt. Ltd.  
G.K.P. Farms Pvt. Ltd.  
Silveroak Estates Pvt. Ltd.  
Bluebells Homes Pvt. Ltd. (Formerly known as Oilintec Pvt. Ltd.)  
Sepoy Drinks Pvt Ltd  
Charisma Homes LLP (Formerly known as Charisma Homes Pvt. Ltd.)  
Avid Maintenance LLP (Formerly known as Avid Maintenance Pvt Ltd)  
Sepoy Beverages LLP  
Gripwel Fasteners (Partnership Firm)  
Farmparts Company (Partnership Firm)  
Soni Holdings (Partnership Firm)  
Indento International (Partnership Firm)  
P Soni Family Trust  
Soni Foundation  
Paramjit Singh (HUF)  
Gurdeep Soni (HUF)  
Leon India (Partnership Firm)  
Paper Bag Entertainment Inc.  
7 Days Film LLC

**Uniparts India Limited**

**Annexure V - Notes to the Restated Consolidated Financial Information**

**(All amounts are in Rs. million, unless stated otherwise)**

The Karan Soni 2018 CG-NG Nevada Trust  
The Meher Soni 2018 CG-NG Nevada Trust  
The Paramjit Soni 2018 CG-NG Nevada Trust  
Gifting Trust of Karan Soni (w.e.f. 18.12.2020)  
Gifting Trust of Meher Soni (w.e.f. 18.12.2020)  
Paramjit Soni Gifting Trust (w.e.f. 01.12.2020)  
Sarabjit Soni Gifting Trust (w.e.f. 01.12.2020)  
Uniparts ESOP Trust  
Ninety Hospitality LLP

**(C) Key Managerial Personnel / Individuals having significant influence on the Company:**

Gurdeep Soni-Chairman & Managing Director  
Paramjit Singh Soni- Vice Chairman & Director  
Herbert Klaus Coenen-Director  
Madhukar Rangnath Umarji- Independent Director (till: 11th April 2020)  
Sanjeev Kumar Chanana-Independent Director (w.e.f : 17th February 2022)  
Sharat Krishan Mathur- Independent Director  
Parmmeet Singh Kalra- Independent Director  
Alok Nagory- Independent Director  
Shradha Suri- Independent Director  
Sanjiv Kashyap - Chief Financial Officer (till: 27th May 2019)  
Munish Sapra- Chief Financial Officer  
Sudhakar Simhachala Kolli - Group Chief Operating Officer  
Mukesh Kumar - Company Secretary (till: 11th February 2021)  
Rini Kalra (Head M&A / Funding) (till 31st March 2020)  
Divya Aggarwal (Company Secretary) (till: 17th April 2020)  
Deepika Sharma (Company Secretary) (till: 10th April 2021)  
Ashish Srivastava (Company Secretary) (till: 18th January 2022)  
Jatin Mahajan (Company Secretary) (w.e.f : 22nd March 2022)

**(D) Relatives of Key Managerial Personnel \***

Angad Soni - Son of Gurdeep Soni  
Pamela Soni - Wife of Gurdeep Soni  
Karan Soni - Son of Paramjit Singh Soni  
Meher Soni - Daughter of Paramjit Singh Soni  
Arjun Soni - Son of Gurdeep Soni  
Tanya Kohli - Daughter of Gurdeep Soni

\*Relatives of Key Managerial Personnel with whom transactions have taken place during the period/years

**Uniparts India Limited**

**Annexure V - Notes to the Restated Consolidated Financial Information**

**(All amounts are in Rs. million, unless stated otherwise)**

(ii) The Key Managerial Personnel, their Relatives and Associates have given certain personal guarantees and collaterals for the loans/other credit facilities taken by the Company from various banks/financial institutions:

S.No.	Name of Bank	Amount Guaranteed				Personal Guarantee	Collateral Security
		As at 31st December 2021 <sup>^</sup>	As at 31st March 2021	As at 31st March 2020	As at 31st March 2019		
1	Kotak Mahindra Bank Limited	-	389.30	561.30	698.50	1. Gurdeep Soni (KMP) 2. Paramjit Singh Soni (KMP) (Up to 2nd December 2020)	1. Mortgage by way of first pari-passu charge on the Apartment # K-0401, 4th Floor, Tower K, Phase IV, Central Park-1, Gurgaon, owned by the Mr. Gurdeep Soni (KMP) and Mrs. Pamela Soni (Relative of KMP).
2	DBS Bank	-	400.00	400.00	400.00	1. Gurdeep Soni (KMP) 2. Paramjit Singh Soni (KMP)	-
3	CitiBank NA	-	-	700.00	700.00	1. Gurdeep Soni (KMP) 2. Paramjit Singh Soni (KMP)	-
4	IndusInd Bank	-	-	-	168.80	1. Gurdeep Soni (KMP) 2. Paramjit Singh Soni (KMP)	Exclusive charge on the Apartment # K-0401, 4th Floor, Tower K, Phase IV, Central Park-1, Gurgaon, owned by the Mr. Gurdeep Soni (KMP) and Mrs. Pamela Soni (Relative of KMP).

<sup>^</sup> During the period ended 31st December 2021, all the personal guarantees/collateral securities of the promoters have been released by the Banks

**Uniparts India Limited**  
**Annexure V - Notes to the Restated Consolidated Financial Information**  
**(All amounts are in Rs. million, unless stated otherwise)**

**(iii) Outstanding balances**

S.No. Particulars	As at 31st December 2021	As at 31st March 2021	As at 31st March 2020	As at 31st March 2019
1 Uniparts ESOP Trust -In Loan Account	53.39	53.39	53.39	53.39

**(iv) Disclosure in respect of Related Party Transactions during the period/year:**

S.No. Particulars	Relationship	For the period ended 31st December 2021	For the year ended 31st March 2021	For the year ended 31st March 2020	For the year ended 31st March 2019
1 <b>Rent Paid</b>					
Soni Holdings	Enterprises over which Key Managerial Personnel and their relatives exercise significant influence	1.49	1.99	1.84	1.87
		<b>1.49</b>	<b>1.99</b>	<b>1.84</b>	<b>1.87</b>
2 <b>Sitting fees</b>					
Alok Nagory	Independent Director	0.16	0.34	0.05	0.20
Madhukar Rangnath Umarji	Independent Director	-	-	0.16	0.39
Sharat Krishan Mathur	Independent Director	0.33	0.55	0.18	0.61
Shradha Suri	Independent Director	0.15	0.15	0.05	0.15
Parmeet Singh Kalra	Independent Director	0.06	0.08	0.02	0.08
		<b>0.70</b>	<b>1.12</b>	<b>0.46</b>	<b>1.43</b>

**Uniparts India Limited**  
**Annexure V - Notes to the Restated Consolidated Financial Information**  
**(All amounts are in Rs. million, unless stated otherwise)**

<b>S.No.</b>	<b>Particulars</b>	<b>Relationship</b>	<b>For the period ended 31st December 2021</b>	<b>For the year ended 31st March 2021</b>	<b>For the year ended 31st March 2020</b>	<b>For the year ended 31st March 2019</b>
<b>3</b>	<b>Dividend Paid</b>					
	Angad Soni	Relative of Key Managerial Personnel	6.60	-	0.06	0.05
	Gurdeep Soni	Key Managerial Personnel	29.68	-	17.95	14.96
	Pamela Soni	Relative of Key Managerial Personnel	9.90	-	2.38	1.98
	Arjun Soni	Relative of Key Managerial Personnel	6.60	-	0.01	0.01
	Paramjit Singh Soni	Key Managerial Personnel	0.66	-	1.20	6.60
	Meher Soni	Relative of Key Managerial Personnel	-	-	1.80	5.20
	Karan Soni	Relative of Key Managerial Personnel	-	-	1.44	5.20
	Rini Kalra	Head M&A / Funding	-	-	0.01	0.01
	Tanya Kohli	Relative of Key Managerial Personnel	3.30	-	-	-
	The Paramjit Soni 2018 CG-NG Nevada Trust	Enterprises over which Key Managerial Personnel and their relatives exercise significant influence	21.10	-	6.71	-
	The Karan Soni 2018 CG-NG Nevada Trust	Enterprises over which Key Managerial Personnel and their relatives exercise significant influence	17.16	-	4.80	-
	The Meher Soni 2018 CG-NG Nevada Trust	Enterprises over which Key Managerial Personnel and their relatives exercise significant influence	17.16	-	4.44	-
	Uniparts ESOP Trust	Enterprises over which Key Managerial Personnel and their relatives exercise significant influence	3.36	-	1.23	1.03
			<b>115.52</b>	<b>-</b>	<b>42.03</b>	<b>35.04</b>
<b>4</b>	<b>Commission</b>					
	Madhukar Rangnath Umarji	Independent Director	-	-	0.30	0.60
			<b>-</b>	<b>-</b>	<b>0.30</b>	<b>0.60</b>
<b>5</b>	<b>Salary and Allowances</b>					
	Angad Soni	Relative of Key Managerial Personnel	-	-	-	2.16
			<b>-</b>	<b>-</b>	<b>-</b>	<b>2.16</b>



**Uniparts India Limited**  
**Annexure V - Notes to the Restated Consolidated Financial Information**  
**(All amounts are in Rs. million, unless stated otherwise)**

S.No.	Particulars	Relationship	For the period ended 31st December 2021	For the year ended 31st March 2021	For the year ended 31st March 2020	For the year ended 31st March 2019
<b>6</b>	<b>Key Managerial Person Remuneration*</b>					
	Sanjiv Kashyap	Chief Financial Officer	-	-	1.27	10.15
	Sudhakar Simhachala Kolli	Group Chief Operating Officer	17.88	17.74	16.79	17.97
	Mukesh Kumar	Company Secretary	-	5.73	6.06	5.42
	Munish Sapra	Chief Financial Officer	10.22	11.83	10.29	2.43
	Rini Kalra	Head M&A / Funding	-	-	6.60	12.70
	Gurdeep Soni	Key Managerial Personnel	19.37	17.34	23.13	18.90
	Paramjit Singh Soni	Key Managerial Personnel	29.24	29.23	37.22	36.71
	Herbert Klaus Coenen	Director	18.68	21.25	20.19	16.99
	Ashish Srivastava	Company Secretary	1.91			
	Divya Aggarwal	Company Secretary	-	0.11	1.25	1.24
	Deepika Sharma	Company Secretary	0.05	0.92	-	-
			<b>97.35</b>	<b>104.15</b>	<b>122.80</b>	<b>122.51</b>
<b>7</b>	<b>ESOP Expenses to Key Managerial Person**</b>					
	Mukesh Kumar	Company Secretary	-	0.08	0.10	0.03
	Sudhakar Simhachala Kolli	Group Chief Operating Officer	0.63	1.61	1.91	0.67
	Rini Kalra	Head M&A / Funding	-	-	1.91	0.67
			<b>0.63</b>	<b>1.69</b>	<b>3.92</b>	<b>1.37</b>

**Notes:**

\* Excludes contribution to employee retirement/post retirement and other employee benefits which are based on actuarial valuation done on an overall Company basis.

\*\* Based on ESOP valuation on the date of grant, the fair value of grant is charged to statement of profit & loss on the basis of vesting period.

**Uniparts India Limited**  
**Annexure V - Notes to the Restated Consolidated Financial Information**  
**(All amounts are in Rs. million, unless stated otherwise)**

**(v) Transactions and outstanding balances with subsidiaries, eliminated during the consolidation for Uniparts India Limited:**

**a. Outstanding Balances**

<b>S.No.</b>	<b>Particulars</b>	<b>Relationship</b>	<b>As at 31st December 2021</b>	<b>As at 31st March 2021</b>	<b>As at 31st March 2020</b>	<b>As at 31st March 2019</b>
1	<b>Gripwel Fasteners Pvt. Ltd.</b>	Subsidiary				
	-In Trade Account		79.92	36.81	10.73	75.59
	-In Equity Shares		49.87	49.87	49.87	49.87
			<b>129.79</b>	<b>86.68</b>	<b>60.60</b>	<b>125.46</b>
2	<b>Uniparts USA Limited</b>	Subsidiary				
	-In Trade Account		138.95	52.38	100.09	50.38
	-In Common Stock		0.87	0.87	0.87	0.87
	-In Preferred Stock		392.67	392.67	392.67	392.67
			<b>532.49</b>	<b>445.92</b>	<b>493.63</b>	<b>443.92</b>
3	<b>Uniparts Europe B.V.</b>	Subsidiary				
	-In Equity Shares		71.06	71.06	71.06	71.06
			<b>71.06</b>	<b>71.06</b>	<b>71.06</b>	<b>71.06</b>
4	<b>Uniparts India GmbH</b>	Subsidiary				
	-In Trade Account		242.86	201.09	171.25	137.48
	-In Equity Shares		5.94	5.94	5.94	5.94
			<b>248.80</b>	<b>207.03</b>	<b>177.19</b>	<b>143.42</b>
5	<b>Uniparts Olsen Inc.</b>	Step-Down Subsidiary				
	-In Trade Account		38.91	33.86	82.57	110.46
			<b>38.91</b>	<b>33.86</b>	<b>82.57</b>	<b>110.46</b>

**Uniparts India Limited**  
**Annexure V - Notes to the Restated Consolidated Financial Information**  
**(All amounts are in Rs. million, unless stated otherwise)**

**b. Transactions during the respective period/year:**

<b>S.No.</b>	<b>Particulars</b>	<b>Relationship</b>	<b>For the period ended 31st December 2021</b>	<b>For the year ended 31st March 2021</b>	<b>For the year ended 31st March 2020</b>	<b>For the year ended 31st March 2019</b>
<b>1</b>	<b>Purchase of Goods/Samples/Packing and Services</b>					
	Gripwel Fasteners Pvt. Ltd.	Subsidiary	21.30	23.96	17.24	12.73
	Uniparts India GmbH	Subsidiary	18.14	22.90	18.41	22.13
			<b>39.44</b>	<b>46.86</b>	<b>35.65</b>	<b>34.86</b>
<b>2</b>	<b>Sale of Goods/Service</b>					
	Gripwel Fasteners Pvt. Ltd.	Subsidiary	773.39	741.72	597.39	780.32
	Uniparts India GmbH	Subsidiary	679.96	643.14	522.52	495.64
	Uniparts Olsen Inc.	Step-Down Subsidiary	854.77	667.59	810.74	1,096.57
	Uniparts USA Limited	Subsidiary	941.06	695.76	719.89	899.73
			<b>3,249.18</b>	<b>2,748.21</b>	<b>2,650.54</b>	<b>3,272.26</b>
<b>3</b>	<b>Sale of Fixed Asset</b>					
	Gripwel Fasteners Pvt. Ltd.	Subsidiary	-	3.42	-	9.03
			<b>-</b>	<b>3.42</b>	<b>-</b>	<b>9.03</b>
<b>4</b>	<b>Job Work income</b>					
	Gripwel Fasteners Pvt. Ltd.	Subsidiary	5.50	2.80	0.84	1.51
			<b>5.50</b>	<b>2.80</b>	<b>0.84</b>	<b>1.51</b>
<b>5</b>	<b>Lease Rent on Machine Received</b>					
	Gripwel Fasteners Pvt. Ltd.	Subsidiary	0.03	0.04	0.04	5.96
			<b>0.03</b>	<b>0.04</b>	<b>0.04</b>	<b>5.96</b>
<b>6</b>	<b>Air Freight Expenses</b>					
	Uniparts India GmbH	Subsidiary	0.57	-	-	-
			<b>0.57</b>	<b>-</b>	<b>-</b>	<b>-</b>
<b>7</b>	<b>Current Account Receipts</b>					
	Gripwel Fasteners Pvt. Ltd.	Subsidiary	10.68	7.62	6.69	12.45
			<b>10.68</b>	<b>7.62</b>	<b>6.69</b>	<b>12.45</b>

**Uniparts India Limited**  
**Annexure V - Notes to the Restated Consolidated Financial Information**  
**(All amounts are in Rs. million, unless stated otherwise)**

<b>S.No.</b>	<b>Particulars</b>	<b>Relationship</b>	<b>For the period ended 31st December 2021</b>	<b>For the year ended 31st March 2021</b>	<b>For the year ended 31st March 2020</b>	<b>For the year ended 31st March 2019</b>
<b>8</b>	<b>Current Account Payments</b>					
	Gripwel Fasteners Pvt. Ltd.	Subsidiary	10.68	7.62	6.69	12.45
			<b>10.68</b>	<b>7.62</b>	<b>6.69</b>	<b>12.45</b>
<b>9</b>	<b>Other Income</b>					
	Uniparts Olsen Inc.	Step-Down Subsidiary	-	0.21	0.62	0.11
	Uniparts USA Limited	Subsidiary	-	-	0.02	0.02
	Uniparts India GmbH	Subsidiary	20.09	30.16	0.74	1.65
	Gripwel Fasteners Pvt. Ltd.	Subsidiary	0.19	0.19	0.26	-
			<b>20.28</b>	<b>30.56</b>	<b>1.64</b>	<b>1.78</b>
<b>10</b>	<b>Guarantees and Collaterals Given to</b>					
	Gripwel Fasteners Pvt. Ltd.	Subsidiary	225.00	225.00	225.00	225.00
			<b>225.00</b>	<b>225.00</b>	<b>225.00</b>	<b>225.00</b>
<b>11</b>	<b>Guarantees and Collaterals Given by</b>					
	Gripwel Fasteners Pvt. Ltd.	Subsidiary	100.00	200.00	200.00	200.00
			<b>100.00</b>	<b>200.00</b>	<b>200.00</b>	<b>200.00</b>
<b>12</b>	<b>Dividend Income</b>					
	Gripwel Fasteners Pvt. Ltd	Subsidiary	50.11	100.80	51.84	37.44
			<b>50.11</b>	<b>100.80</b>	<b>51.84</b>	<b>37.44</b>

**Uniparts India Limited**  
**Annexure V - Notes to the Restated Consolidated Financial Information**  
**(All amounts are in Rs. million, unless stated otherwise)**

**(vi) Transactions and outstanding balances entered by Gripwel Fasteners Private Limited with fellow subsidiaries, eliminated during the consolidation:**

**a. Outstanding Balances**

S.No.	Particulars	Relationship	As at 31st December 2021	As at 31st March 2021	As at 31st March 2020	As at 31st March 2019
1	<b>Uniparts USA Limited</b> -In Trade Account	Fellow Subsidiary	82.57	78.06	134.29	155.14
2	<b>Uniparts India GmbH</b> -In Trade Account	Fellow Subsidiary	74.40	46.91	23.20	80.30
3	<b>Uniparts Olsen Inc.</b> -In Trade Account	Fellow Subsidiary	58.18	52.93	134.43	66.58

**b. Transactions during the respective period / year:**

S.No.	Particulars	Relationship	For the period ended 31st December 2021	For the year ended 31st March 2021	For the year ended 31st March 2020	For the year ended 31st March 2019
1	<b>Purchase of Goods/Samples/Packing and Services</b>					
	Uniparts India GmbH	Fellow Subsidiary	-	12.10	5.06	6.48
			<b>-</b>	<b>12.10</b>	<b>5.06</b>	<b>6.48</b>
2	<b>Sale of Goods</b>					
	Uniparts India GmbH	Fellow Subsidiary	231.94	171.35	103.05	210.18
	Uniparts USA Limited	Fellow Subsidiary	343.74	350.33	289.82	315.11
	Uniparts Olsen Inc.	Fellow Subsidiary	326.51	225.69	261.49	364.67
			<b>902.19</b>	<b>747.37</b>	<b>654.36</b>	<b>889.96</b>
2	<b>Other Income</b>					
	Uniparts Olsen Inc.	Fellow Subsidiary	0.06	-	-	-
			<b>0.06</b>	<b>-</b>	<b>-</b>	<b>-</b>

**Uniparts India Limited**  
**Annexure V - Notes to the Restated Consolidated Financial Information**  
**(All amounts are in Rs. million, unless stated otherwise)**

(vii) Transactions and outstanding balances entered by Uniparts Europe BV with fellow subsidiary other than the transactions reported in other sections, eliminated during the consolidation:

**a. Outstanding Balances**

S.No.	Particulars	Relationship	As at 31st December 2021	As at 31st March 2021	As at 31st March 2020	As at 31st March 2019
1	<b>Uniparts India GmbH</b>	Fellow Subsidiary				
	-In Loan and Advance Account (Euro 6,00,000)		50.81	51.48	49.87	46.57
	-In Other Receivables		0.89	2.10	0.82	0.54
			<b>51.71</b>	<b>53.58</b>	<b>50.68</b>	<b>47.11</b>

**b. Transactions during the respective period / year:**

S.No.	Particulars	Relationship	For the period ended 31st December 2021	For the year ended 31st March 2021	For the year ended 31st March 2020	For the year ended 31st March 2019
1	<b>Interest Income</b> Uniparts India GmbH	Fellow Subsidiary	0.92	1.21	1.11	1.13

(viii) Transactions and outstanding balances entered by Uniparts Olsen Inc. with fellow subsidiary other than the transactions reported in other sections, eliminated during the consolidation:

**a. Outstanding Balances**

S.No.	Particulars	Relationship	As at 31st December 2021	As at 31st March 2021	As at 31st March 2020	As at 31st March 2019
1	<b>Uniparts India GmbH</b> -In Trade Account	Fellow Subsidiary	-	-	0.03	-

**Uniparts India Limited**  
**Annexure V - Notes to the Restated Consolidated Financial Information**  
**(All amounts are in Rs. million, unless stated otherwise)**

**b. Transactions during the respective period / year:**

S.No.	Particulars	Relationship	For the period ended 31st December 2021	For the year ended 31st March 2021	For the year ended 31st March 2020	For the year ended 31st March 2019
1	<b>Sale of Goods/Service</b>					
	Uniparts USA Limited	Fellow Subsidiary	-	1.79		
	Uniparts India GmbH	Fellow Subsidiary	5.23	9.55		
			<u>5.23</u>	<u>11.34</u>	-	-

**(ix) Transactions and outstanding balances entered by Uniparts USA Limited with fellow subsidiary other than the transactions reported in other sections, eliminated during the consolidation:**

**a. Outstanding Balances**

S.No.	Particulars	Relationship	As at 31st December 2021	As at 31st March 2021	As at 31st March 2020	As at 31st March 2019
1	<b>Uniparts Olsen Inc.</b>	Fellow Subsidiary				
	- In Common Stock		623.31	612.09	630.42	578.96
	(US \$ 8,367,665)					
	-In Other Payable		-	(37.39)	(31.43)	(35.43)
			<u>623.31</u>	<u>574.70</u>	<u>598.99</u>	<u>543.53</u>

**b. Transactions during the respective period / year:**

S.No.	Particulars	Relationship	For the period ended 31st December 2021	For the year ended 31st March 2021	For the year ended 31st March 2020	For the year ended 31st March 2019
1	<b>Sale of Goods/Service</b>					
	Uniparts India GmbH	Fellow Subsidiary	1.41	-	-	-
			<u>1.41</u>	<u>-</u>	<u>-</u>	<u>-</u>

**Uniparts India Limited****Annexure V - Notes to the Restated Consolidated Financial Information**

(All amounts are in Rs. million, unless stated otherwise)

**(x) Funding arrangements including inter-se guarantees among the entities consolidated excluding contribution to equity share capital:**

<b>Executed by</b>	<b>On behalf of</b>	<b>For the period ended 31st December 2021</b>	<b>For the year ended 31st March 2021</b>	<b>For the year ended 31st March 2020</b>	<b>For the year ended 31st March 2019</b>
Uniparts India Limited	Gripwel Fasteners Pvt. Ltd.	225.00	225.00	225.00	225.00
Gripwel Fasteners Pvt. Ltd.	Uniparts India Limited	100.00	200.00	200.00	200.00
Uniparts USA Limited	Uniparts Olsen Inc.	335.21	329.18	791.07	726.50
Uniparts Olsen Inc.	Uniparts USA Limited	260.72	365.75	565.05	518.93
There is no important terms and conditions and fund transfer restrictions on the above Funding arrangements					

**Loans**

<b>Lender</b>	<b>Borrower</b>	<b>For the period ended 31st December 2021</b>	<b>For the year ended 31st March 2021</b>	<b>For the year ended 31st March 2020</b>	<b>For the year ended 31st March 2019</b>
Uniparts Europe BV	Uniparts India GmbH	50.81	51.48	49.87	46.57
Interest will be paid on EURIBOR + 230 bps, there is no other important terms and conditions and fund transfer restrictions on the above Funding arrangement.					



**Uniparts India Limited****Annexure V - Notes to the Restated Consolidated Financial Information****(All amounts are in Rs. million, unless stated otherwise)**

39. The consolidated financial statements include results of all the subsidiaries of Uniparts India Limited and interalia their subsidiaries & Associates. The names, country of incorporation or residence, proportion of ownership interest and reporting dates are as under:-

**(a) Subsidiaries**

Name of the company	Country of Incorporation	% of voting power held as at 31st December 2021	% of voting power held as at 31st March 2021	% of voting power held as at 31st March 2020	% of voting power held as at 31st March 2019
Uniparts USA Limited	USA	100.00	100.00	100.00	100.00
Uniparts Europe BV	Netherlands	100.00	100.00	100.00	100.00
Gripwel Fasteners Private Limited	India	100.00	100.00	100.00	100.00
Uniparts India GmbH	Germany	100.00	100.00	100.00	100.00
Gripwel Conag Private Limited	India	100.00	NA	NA	NA

**(b) Step down Subsidiaries**

Name of the company	Country of Incorporation	% of voting power held as at 31st December 2021	% of voting power held as at 31st March 2021	% of voting power held as at 31st March 2020	% of voting power held as at 31st March 2019
Uniparts Olsen Inc.	USA	100.00	100.00	100.00	100.00

**Uniparts India Limited**
**Annexure V - Notes to the Restated Consolidated Financial Information**
**(All amounts are in Rs. million, unless stated otherwise)**
**Additional information, as required under Schedule III to the Companies Act, 2013, of enterprise consolidated as subsidiary/ Associates/ Joint Venture.**

Name of the Enterprise	Net Assets i.e. total assets minus total liabilities		Share in Profit or Loss		Share in Other Comprehensive Income		Share in Total Comprehensive Income	
	As % of consolidated net assets	Amount	As % of consolidated profits	Amount	As % of Consolidated Other Comprehensive Income	Amount	As % of Consolidated Total Comprehensive Income	Amount
<b>Parent:</b>								
<b>Uniparts India Limited</b>								
Balance as at 31st December 2021	57.29%	3,815.08	59.87%	732.41	38.46%	(6.33)	60.16%	726.08
Balance as at 31st March 2021	57.43%	3,212.32	46.97%	433.94	184.92%	44.88	50.50%	478.82
Balance as at 31st March 2020	58.80%	2,729.47	25.16%	157.62	20.85%	(30.50)	26.48%	127.12
Balance as at 31st March 2019	62.58%	2,640.56	33.69%	234.44	(6.88%)	4.90	38.31%	239.34
<b>Subsidiaries:</b>								
<b>- Indian</b>								
<b>1 Gripwel Fasteners Private Limited</b>								
Balance as at 31st December 2021	13.91%	926.32	19.84%	242.66	(28.55%)	4.70	20.50%	247.36
Balance as at 31st March 2021	13.03%	728.73	23.31%	215.31	94.31%	22.89	25.12%	238.20
Balance as at 31st March 2020	12.77%	592.60	20.02%	125.41	9.73%	(14.24)	23.15%	111.17
Balance as at 31st March 2019	11.47%	484.06	23.02%	160.21	3.41%	(2.43)	25.25%	157.78

**Uniparts India Limited**
**Annexure V - Notes to the Restated Consolidated Financial Information**

(All amounts are in Rs. million, unless stated otherwise)

Name of the Enterprise	Net Assets i.e. total assets minus total liabilities		Share in Profit or Loss		Share in Other Comprehensive Income		Share in Total Comprehensive Income	
	As % of consolidated net assets	Amount	As % of consolidated profits	Amount	As % of Consolidated Other Comprehensive Income	Amount	As % of Consolidated Total Comprehensive Income	Amount
<b>- Foreign</b>								
<b>1 Uniparts USA Limited</b>								
Balance as at 31st December 2021	19.19%	1,278.25	13.02%	159.23	0.00%	-	13.19%	159.23
Balance as at 31st March 2021	19.84%	1,109.78	13.89%	128.28	0.00%	-	13.53%	128.28
Balance as at 31st March 2020	21.48%	997.01	26.39%	165.34	0.00%	-	34.44%	165.34
Balance as at 31st March 2019	6.03%	254.50	17.49%	121.71	0.00%	-	19.48%	121.71
<b>2 Uniparts Olsen Inc.</b>								
Balance as at 31st December 2021	25.65%	1,708.18	11.06%	135.33	0.00%	-	11.21%	135.33
Balance as at 31st March 2021	27.88%	1,559.81	15.12%	139.71	0.00%	-	14.74%	139.71
Balance as at 31st March 2020	30.88%	1,433.19	22.01%	137.90	0.00%	-	28.72%	137.90
Balance as at 31st March 2019	23.72%	1,001.09	25.27%	175.89	0.00%	-	28.15%	175.89
<b>3 Uniparts Europe B.V.</b>								
Balance as at 31st December 2021	0.81%	53.63	0.04%	0.44	0.00%	-	0.04%	0.44
Balance as at 31st March 2021	0.96%	53.90	(0.12%)	(1.09)	0.00%	-	(0.11%)	(1.09)
Balance as at 31st March 2020	1.15%	53.26	0.01%	0.05	0.00%	-	0.01%	0.05
Balance as at 31st March 2019	(0.85%)	(35.76)	(0.02%)	(0.15)	0.00%	-	(0.02%)	(0.15)

**Uniparts India Limited**
**Annexure V - Notes to the Restated Consolidated Financial Information**

(All amounts are in Rs. million, unless stated otherwise)

Name of the Enterprise	Net Assets i.e. total assets minus total liabilities		Share in Profit or Loss		Share in Other Comprehensive Income		Share in Total Comprehensive Income	
	As % of consolidated net assets	Amount	As % of consolidated profits	Amount	As % of Consolidated Other Comprehensive Income	Amount	As % of Consolidated Total Comprehensive Income	Amount
<b>4 Uniparts India GmbH</b>								
Balance as at 31st December 2021	3.46%	230.32	6.29%	76.92	0.00%	-	6.37%	76.92
Balance as at 31st March 2021	2.64%	147.70	5.33%	49.25	0.00%	-	5.19%	49.25
Balance as at 31st March 2020	2.23%	103.49	6.51%	40.81	0.00%	-	8.50%	40.81
Balance as at 31st March 2019	1.57%	66.11	3.33%	23.18	0.00%	-	3.71%	23.18
Adjustments arising out of consolidation								
Balance as at 31st December 2021	(20.30%)	(1,352.16)	(9.18%)	(112.30)	90.10%	(14.83)	(10.53%)	(127.13)
Balance as at 31st March 2021	(21.98%)	(1,229.76)	(5.77%)	(53.27)	(179.23%)	(43.50)	(10.21%)	(96.77)
Balance as at 31st March 2020	(27.30%)	(1,266.97)	0.06%	0.40	68.13%	(99.67)	(20.68%)	(99.27)
Balance as at 31st March 2019	(4.31%)	(181.68)	(2.16%)	(15.05)	106.11%	(75.52)	(14.50%)	(90.57)

**Uniparts India Limited**
**Annexure V - Notes to the Restated Consolidated Financial Information**
**(All amounts are in Rs. million, unless stated otherwise)**

Name of the Enterprise	Net Assets i.e. total assets minus total liabilities		Share in Profit or Loss		Share in Other Comprehensive Income		Share in Total Comprehensive Income	
	As % of consolidated net assets	Amount	As % of consolidated profits	Amount	As % of Consolidated Other Comprehensive Income	Amount	As % of Consolidated Total Comprehensive Income	Amount
Adjustments arising out of restated consolidation								
Balance as at 31st December 2021	0.00%	-	(0.93%)	(11.33)	0.00%	-	(0.94%)	(11.33)
Balance as at 31st March 2021	0.20%	11.33	1.27%	11.73	0.00%	-	1.24%	11.73
Balance as at 31st March 2020	(0.01%)	(0.40)	(0.18%)	(1.11)	1.29%	(1.88)	(0.62%)	(2.99)
Balance as at 31st March 2019	(0.21%)	(9.07)	(0.61%)	(4.26)	(2.64%)	1.88	(0.38%)	(2.38)
Total after elimination on account of consolidation- 31st December 2021	100.00%	6,659.62	100.00%	1,223.36	100.00%	(16.46)	100.00%	1,206.90
Total after elimination on account of consolidation- 31st March 2021	100.00%	5,593.81	100.00%	923.86	100.00%	24.27	100.00%	948.13
Total after elimination on account of consolidation- 31st March 2020	100.00%	4,641.65	100.00%	626.42	100.00%	(146.29)	100.00%	480.13
Total after elimination on account of consolidation- 31st March 2019	100.00%	4,219.81	100.00%	695.97	100.00%	(71.17)	100.00%	624.80

**Uniparts India Limited****Annexure V - Notes to the Restated Consolidated Financial Information****(All amounts are in Rs. million, unless stated otherwise)****40. Hedging activities and Derivatives**

The Company uses foreign currency denominated borrowings and foreign exchange forward contracts for the purpose of hedging its currency risks. These contracts are not intended for trading or speculation. The foreign exchange forward contracts are designated as cash flow hedges.

**Cash flow hedges**

Foreign exchange forward contracts measured at fair value through OCI are designated as hedging instruments in cash flow hedges of forecast sales in US dollar. These forecast transactions are highly probable.

Foreign exchange forward contracts measured at fair value through OCI are designated as hedging instruments in cash flow hedges of forecast sales in US dollar. These forecast transactions are highly probable.

The foreign exchange forward contract balances vary with the level of expected foreign currency sales and purchases and changes in foreign exchange forward rates.

The terms of the foreign currency forward contracts match the terms of the expected highly probable forecast transactions. As a result, no hedge ineffectiveness arise requiring recognition through profit or loss. Notional amounts of outstanding forward contracts are as follows :

S.No.	Particulars	As at 31st December 2021		As at 31st March 2021		As at 31st March 2020		As at 31st March 2019		
		Foreign Currency	INR	Foreign Currency	INR	Foreign Currency	INR	Foreign Currency	INR	
1	Forward Contract USD	Hedging of highly probable sales	35.08	2,096.82	17.70	1,302.70	20.03	1,483.41	7.10	512.87
2	Forward Contract EUR	Hedging of highly probable sales	-	-	3.00	265.47	-	-	-	-

The cash flow hedges of the expected future sales during the year ended 31st December 2021 were assessed to be effective and an unrealised profit of Rs.10.06 million, with a deferred tax liability of Rs. 2.53 million relating to the hedging instruments is included in OCI. The cash flow hedges of the expected future sales during the year ended 31st March 2021 were assessed to be effective and an unrealised profit of Rs. 89.87 million, with a deferred tax liability of Rs. 22.62 million relating to the hedging instruments is included in OCI. The cash flow hedges of the expected future sales during the year ended 31st March 2020 were assessed to be effective and an unrealised Loss of Rs. 69.19 million, with a deferred tax assets of Rs. 17.41 million was included in OCI. The cash flow hedges of the expected future sales during the year ended 31st March 2019 were assessed to be effective and an unrealised gain of Rs. 14.70 million, with a deferred tax liability of Rs. 5.14 million was included in OCI in respect of these contracts.

The amount removed from OCI during the period and recognised in the statement of profit & loss for the period ended 31st December 2021 is detailed in Note 29 totalling Rs. 67.25 million (net of tax) [March 31, 2021: Rs. (51.78) million (net of tax), March 31, 2020: Rs. 9.56 million (net of tax), [March 31, 2019: Rs. 1.40 million (net of tax)]]. The amounts retained in OCI at 31st December 2021 are expected to mature and affect the statement of profit and loss till period ended 31st December 2022.

**Reclassifications to profit or loss during the year gains or losses included in OCI are shown in Note 29.**

## **Uniparts India Limited**

### **Annexure V - Notes to the Restated Consolidated Financial Information**

**(All amounts are in Rs. million, unless stated otherwise)**

#### **41. Financial Risk Management Objectives and Policies**

The Company's principal financial liabilities other than derivatives, comprise loans and borrowings, trade payables, employee related payables and other payables. The main purpose of these financial liabilities is to finance the Company's operations. The Company's principal financial assets include loan to employees, trade receivables & other receivables and cash and cash equivalents that derive directly from its operations.

The Company is exposed to market risk, credit risk and liquidity risk. The Company's senior management oversees the management of these risks. The Company's senior management is supported by a Audit committee that advises on financial risks and the appropriate financial risk governance framework for the Company. The Audit committee provides assurance that the Company's financial risk activities are governed by appropriate policies and procedures and that financial risks are identified, measured and managed in accordance with the Company's policies and risk objectives. All derivative activities for risk management purposes are carried out by experienced members from the senior management who have the relevant expertise, appropriate skills and supervision. It is the Company's policy that no trading in derivatives for speculative purposes may be undertaken. The Board of Directors reviews and agrees policies for managing each of these risks, which are summarised as below.

##### **a) Market risk**

Market risk is the risk that the fair value of future cash flows of a financial instrument will fluctuate because of changes in market prices. Market prices are subject to commodity price risk, foreign exchange risk and interest rate risk.

The financial instruments that are affected by these include loans and borrowing, deposits, available-for-sale investments and derivative financial instruments. We, from time to time, undertake analysis in relation to the amount of our net debt, the ratio of fixed to floating interest rates of our debt and our financial instruments that are in foreign currencies. We use derivative financial instruments such as foreign exchange contracts to manage our exposures to foreign exchange fluctuations.

**Uniparts India Limited**

**Annexure V - Notes to the Restated Consolidated Financial Information**

**(All amounts are in Rs. million, unless stated otherwise)**

**b) Interest rate risk**

Interest rate risk is the risk that the fair value or future cash flows of a financial instrument will fluctuate because of changes in market interest rates. The Company's exposure to the risk of changes in market interest rates relates primarily to the Company's long-term debt obligations with floating interest rates. The interest rate on remaining loans (except vehicle loans), although fixed, is subject to periodic review by lending banks / financial institutions in relation to their respective base lending rates, which may vary over a period result of any change in the monetary policy of the Reserve Bank of India.

<b>Particulars</b>	<b>As at 31st December 2021</b>	<b>As at 31st March 2021</b>	<b>As at 31st March 2020</b>	<b>As at 31st March 2019</b>
<b>Variable rate borrowings</b>				
Long Term	-	-	-	-
Short Term*	1,335.33	1,141.34	2,115.95	2,716.63
<b>Total Variable rate borrowings</b>	<b>1,335.33</b>	<b>1,141.34</b>	<b>2,115.95</b>	<b>2,716.63</b>
<b>Fixed rate borrowings</b>				
Long Term	74.25	136.43	406.37	639.53
Short Term	-	-	-	-
<b>Total fixed rate borrowings</b>	<b>74.25</b>	<b>136.43</b>	<b>406.37</b>	<b>639.53</b>
<b>Total</b>	<b>1,409.58</b>	<b>1,277.77</b>	<b>2,522.32</b>	<b>3,356.16</b>

\*Excluding Bills discounted with Bank



**Uniparts India Limited**  
**Annexure V - Notes to the Restated Consolidated Financial Information**  
**(All amounts are in Rs. million, unless stated otherwise)**

**Interest rate sensitivity**

Variable interest rate loans are exposed to Interest rate risk, the impact on profit or loss before tax may be as follows:

Particulars	Effect on profit and equity			
	For the period ended 31st December 2021	For the year ended 31st March 2021	For the year ended 31st March 2020	For the year ended 31st March 2019
Interest rate - increase by 100 basis points (100 bps)*	(13.35)	(11.41)	(21.59)	(23.35)
Interest rate - decrease by 100 basis points (100 bps)*	13.35	11.41	21.59	23.35

\* Holding all other variable constant

The assumed movement in basis points for the interest rate sensitivity analysis is based on the currently observable market environment, showing a significantly higher volatility than in prior years.

**c) Foreign currency risk**

Foreign currency risk is the risk that the fair value or future cash flows of an exposure will fluctuate because of changes in foreign exchange rates. The Company's exposure to the risk of changes in foreign exchange rates relates primarily to the Company's export revenue and long term foreign currency

The Company have long term agreements with its major customers, the company face foreign exchange risk in respect of (I) our foreign currency loans, in respect of which selectively hedge currency exchange rate risk, (ii) currency mismatches between income and expenditures, which the company seek to manage as much as possible by matching income currency to expenditure currency, and (iii) currency translation for the purpose of preparing consolidated financial statements, on account of global operations.

**Uniparts India Limited**

**Annexure V - Notes to the Restated Consolidated Financial Information**

**(All amounts are in Rs. million, unless stated otherwise)**

The period/year end foreign currency exposures that have not been hedged by a derivative instrument or otherwise are given below:

Particulars	Currency	Description	For the period ended 31st December 2021	For the year ended 31st March 2021	For the year ended 31st March 2020	For the year ended 31st March 2019
a)	Receivables					
	USD	Sale	4.13	3.43	6.71	1.79
	EUR	Sale	4.69	1.33	-	4.23
	JPY	Sale	36.09	20.71	13.23	22.42
	AUD	Sale	0.60	0.51	0.18	0.41
	GBP	Sale	0.55	0.44	0.09	0.38
b)	Payables					
	USD	Purchase	0.67	0.47	0.24	0.64
	EUR	Purchase	-	-	0.01	0.02
c)	Loans					
	USD	PCFC / PSFC Loan	5.09	3.99	-	12.71
	EUR	PCFC / PSFC Loan	-	-	12.22	-
	USD	FCTL Loan	-	0.17	1.20	2.23
d)	Bank					
	USD	EEFC	0.02	-	-	-
	EUR	EEFC	-	-	-	-
e)	Other Receivable					
	USD		0.12	0.06	0.02	0.02
	EUR		-	-	-	-
f)	Other Payables					
	USD		-	0.01	-	0.01
	JPY		0.97	2.42	0.97	4.22

**Uniparts India Limited**  
**Annexure V - Notes to the Restated Consolidated Financial Information**  
**(All amounts are in Rs. million, unless stated otherwise)**

**Foreign currency sensitivity**

With respect to the above unhedged exposure the sensitivity is as follows:

Particulars	Effect on profit and equity			
	For the period ended 31st December 2021	For the year ended 31st March 2021	For the year ended 31st March 2020	For the year ended 31st March 2019
INR/USD-Increase by 5%	(5.49)	(4.20)	19.94	(47.63)
INR/EUR-Increase by 5%	20.13	5.72	(50.81)	16.33
INR/GBP-Increase by 5%	2.76	2.22	0.40	1.70
INR/JPY-Increase by 5%	1.16	0.60	0.42	0.57
INR/AUD-Increase by 5%	1.68	1.43	0.42	1.00
INR/USD-Decrease by 5%	5.49	4.20	(19.94)	47.63
INR/EUR-Decrease by 5%	(20.13)	(5.72)	50.81	(16.33)
INR/GBP-Decrease by 5%	(2.76)	(2.22)	(0.40)	(1.70)
INR/JPY-Decrease by 5%	(1.16)	(0.60)	(0.42)	(0.57)
INR/AUD-Decrease by 5%	(1.68)	(1.43)	(0.42)	(1.00)

**d) Commodity price risk**

Commodity price risk is the possibility of impact from changes in the prices of raw materials such as steel, which we use in the manufacture of our products. While we seek to pass on input cost increases to our customers, we may not be able to fully achieve this in all situations or at all times.

**Commodity price sensitivity**

As the Company has a back to back pass through arrangements for volatility in raw material prices there is no impact on the profit and loss and equity of the Company.

**Uniparts India Limited****Annexure V - Notes to the Restated Consolidated Financial Information****(All amounts are in Rs. million, unless stated otherwise)****e) Credit risk**

Credit risk is the risk that counterparty will not meet its obligations under a financial instrument or customer contract, leading to a financial loss. The Company is exposed to credit risk from its operating activities (primarily trade receivables) and from its financing activities, including deposits with banks and financial institutions, investment in mutual funds, other receivables and deposits, foreign exchange transactions and other financial instruments.

In relation to credit risk arising from financing activities, we monitor our credit spreads and financial strength on a regular basis, and based on our on-going assessment of counterparty risk, we adjust our exposure to various counterparties.

For the period ended 31st December 2021, year ended 31st March 2021, year ended 31st March 2020 and year ended 31st March 2019 the Company had made provision for doubtful debts amounting to Rs. 1.25 million Rs. 2.14 million , Rs. 8.49 million and Rs. 6.14 million respectively.

**f) Liquidity risk**

Liquidity risk is the risk that the Company will encounter difficulty in meeting the obligations associated with its financial liabilities that are settled by delivering cash or another financial asset. The Company's approach to managing liquidity is to ensure, as far as possible, that it will have sufficient liquidity to meet its liabilities when they are due, under both normal and stressed conditions, without incurring unacceptable losses or risking damage to the Company's reputation and on-going business.

The Company manages liquidity risk by maintaining adequate reserves, banking facilities and reserve borrowing facilities, by continuously monitoring forecast and actual cash flows, and by matching the maturity profiles of financial assets and liabilities.

<b>Particulars</b>	<b>As at 31st December 2021</b>	<b>As at 31st March 2021</b>	<b>As at 31st March 2020</b>	<b>As at 31st March 2019</b>
Total Committed working capital limits from Banks	2,396.43	2,628.40	2,954.42	3,037.65
Less: Utilized working capital limit	1,335.33	1,141.34	2,158.60	2,816.75
<b>Unutilized working capital limit</b>	<b>1,061.10</b>	<b>1,487.06</b>	<b>795.82</b>	<b>220.90</b>

**Uniparts India Limited**  
**Annexure V - Notes to the Restated Consolidated Financial Information**  
**(All amounts are in Rs. million, unless stated otherwise)**

**g) Maturities of financial liabilities**

The tables below analyse the Company's financial liabilities into relevant maturity groupings based on their contractual maturities. The amount disclosed in the table are the contractual undiscounted cash flow.

Particulars	For the period ended 31st December 2021	For the year ended 31st March 2021	For the year ended 31st March 2020	For the year ended 31st March 2019
<b>1 Long Term Borrowings</b>				
Upto 1 year	59.11	79.26	190.25	164.38
Between 1 to 5 years	15.14	57.17	216.12	475.15
Over 5 years	-	-	-	-
<b>2 Short Term Borrowings</b>				
Upto 1 year	1,335.33	1,141.34	2,158.60	2,816.75
Between 1 to 5 years	-	-	-	-
Over 5 years	-	-	-	-
<b>3 Lease Liabilities</b>				
Upto 1 year	52.53	65.32	72.42	73.39
Between 1 to 5 years	163.72	176.65	207.09	226.19
Over 5 years	85.58	101.92	139.53	163.35
<b>4 Trade Payables</b>				
Upto 1 year	860.64	900.92	526.81	698.36
Between 1 to 5 years	-	-	-	-
Over 5 years	-	-	-	-
<b>Total</b>	<b>2,572.05</b>	<b>2,522.58</b>	<b>3,510.82</b>	<b>4,617.57</b>

**Uniparts India Limited**

**Annexure V - Notes to the Restated Consolidated Financial Information**

(All amounts are in Rs. million, unless stated otherwise)

**42. Financial Instruments by category and Fair value hierarchy**

Set out below, is a comparison by class of the carrying amounts and fair value of the Company's financial instruments, other than those with carrying amounts that are reasonable approximations of fair values:

Particular	Level of Input	Carrying amount				Fair value			
		As at 31st December 2021	As at 31st March 2021	As at 31st March 2020	As at 31st March 2019	As at 31st December 2021	As at 31st March 2021	As at 31st March 2020	As at 31st March 2019
<b>Financial Assets</b>									
Loan to Employees		3.77	3.44	1.70	4.90	3.77	3.44	1.70	4.90
Security Deposits		46.11	44.36	50.34	51.32	46.11	44.36	50.34	51.32
Derivative instruments	Level 1	45.44	35.38	-	14.70	45.44	35.38	-	14.70
Investments	Level 1	17.58	12.50	-	-	17.58	12.50	-	-
Trade Receivables		1,613.74	1,675.32	1,228.35	1,453.58	1,613.74	1,675.32	1,228.35	1,453.58
Cash & Bank Balances		131.73	108.18	169.56	150.93	131.73	108.18	169.56	150.93
Other Receivables		0.45	0.46	0.47	0.48	0.45	0.46	0.47	0.48
<b>Financial Liabilities</b>									
Borrowings		1,409.58	1,277.77	2,564.97	3,456.28	1,409.58	1,277.77	2,564.97	3,456.28
Trade Payables		860.64	900.92	526.81	698.36	860.64	900.92	526.81	698.36
Lease liabilities		301.83	343.89	419.04	462.93	301.83	343.89	419.04	462.93
Derivative instruments	Level 1	-	-	54.49	-	-	-	54.49	-

The management assessed that the fair value of cash and cash equivalent, trade receivables, derivative instruments, trade payables and other current financial assets and liabilities approximate their carrying amounts largely due to the short term maturities of these instruments.

The fair value of the financial assets and liabilities is included at the amount at which the instrument could be exchanged in a current transaction between willing parties, other than in a forced or liquidation sale. The following methods and assumptions were used to estimate the fair values: .

(i) Long-term fixed-rate and variable-rate receivables are evaluated by the Company based on parameters such as individual creditworthiness of the customer. Based on this evaluation, allowances are taken into account for the expected credit losses of these receivables.

(ii) The fair value of other non-current financial liabilities and security deposits, is estimated by discounting future cash flows using 10 year government bond rates. In addition to being sensitive to a reasonably possible change in the forecast cash flows or the discount rate, the fair value of the equity instruments is also sensitive to a reasonably possible change in the growth rates.

(iii) Further the management assessed that the fair value of loan to employees approximate their carrying amounts largely due to discounting at rates which are an approximation of current lending rates.

**Uniparts India Limited****Annexure V - Notes to the Restated Consolidated Financial Information****(All amounts are in Rs. million, unless stated otherwise)**

(iv) The Company enters into derivative financial instruments with various counterparties, principally financial institutions with investment grade credit ratings. Foreign exchange forward contracts are valued using valuation techniques, which employs the use of market observable inputs. The most frequently applied valuation techniques include forward pricing using present value calculations. The models incorporate various inputs including the credit quality of counterparties, foreign exchange spot and forward rates, yield curves of the respective currencies, currency basis spreads between the respective currencies and forward rate curves of the underlying. All derivative contracts are fully cash collateralised, thereby eliminating both counterparty and the Company's own non-performance risk. As at 31st December 2021 the marked-to-market value of derivative asset positions is net of a credit valuation adjustment attributable to derivative counterparty default risk. The changes in counterparty credit risk had no material effect on the hedge effectiveness assessment for derivatives designated in hedge relationships and other financial instruments recognised at fair value.

**Reconciliation of fair value measurement of financial assets classified as FVTOCI:**

Particulars	For the period	For the year	For the year	For the year
	ended	ended	ended	ended
	31st December	31st March	31st March	31st March
	2021	2021	2020	2019
Derivatives	45.44	35.38	-	14.70

**Reconciliation of fair value measurement of financial assets classified as FVTPL:**

Particulars	For the period	For the year	For the year	For the year
	ended	ended	ended	ended
	31st December	31st March	31st March	31st March
	2021	2021	2020	2019
Investments	17.58	12.50	-	-

**Uniparts India Limited**  
**Annexure V - Notes to the Restated Consolidated Financial Information**  
**(All amounts are in Rs. million, unless stated otherwise)**

**43. Capital management**

The capital includes issued equity capital and other equity reserves attributable to the equity holders of the company. The primary objective of the company's capital management is to maintain optimum capital structure to reduce cost of capital and to maximize the shareholder value.

The company manages its capital structure and makes adjustments in light of changes in economic conditions and the requirements of the financial covenants which otherwise would permit the banks to call loans and borrowings in part or in whole. In order to maintain or adjust the capital structure, the company may adjust the dividend payment to shareholders, return capital to shareholders or issue new shares.

<b>Particulars</b>	<b>For the period ended 31st December 2021</b>	<b>For the year ended 31st March 2021</b>	<b>For the year ended 31st March 2020</b>	<b>For the year ended 31st March 2019</b>
<b>Borrowings</b>	1,409.58	1,277.77	2,564.97	3,456.28
Less: cash and other liquid assets	131.73	108.18	169.56	150.93
<b>Net Debt</b>	1,277.85	1,169.59	2,395.41	3,305.35
<b>Equity</b>	6,659.62	5,593.81	4,641.65	4,219.81
<b>Net Debt/Equity ratio</b>	<b>0.19</b>	<b>0.21</b>	<b>0.52</b>	<b>0.78</b>

**44. Ratios as per the Schedule III requirements**

**a) Current Ratio = Current Assets divided by Current Liabilities**

<b>Particulars</b>	<b>31st December 2021</b>	<b>31st March 2021</b>	<b>31st March 2020</b>	<b>31st March 2019</b>
Current Assets	6,686.62	5,506.03	5,322.26	5,735.22
Current Liabilities	2,734.15	2,562.11	3,394.53	4,086.86
<b>Ratio</b>	<b>2.45</b>	<b>2.15</b>	<b>1.57</b>	<b>1.40</b>
<b>% Change from previous period / year</b>	<b>13.80%</b>	<b>37.06%</b>	<b>11.73%</b>	

Reason for change more than 25%:

The ratio has been increased from 1.57 in 31st March 2020 to 2.15 in 31st March 2021 mainly due to repayment of borrowings during the year.



**Uniparts India Limited**

**Annexure V - Notes to the Restated Consolidated Financial Information**

(All amounts are in Rs. million, unless stated otherwise)

**b) Debt Equity ratio = Total debt divided by Total equity where total debt refers to sum of current & non current borrowings**

Particulars	31st December 2021	31st March 2021	31st March 2020	31st March 2019
Total debt	1,409.58	1,277.77	2,564.97	3,456.28
Total equity	6,659.62	5,593.81	4,641.65	4,219.81
<b>Ratio</b>	<b>0.21</b>	<b>0.23</b>	<b>0.55</b>	<b>0.82</b>
<b>% Change from previous period / year</b>	<b>(7.34)%</b>	<b>(58.66)%</b>	<b>(32.53)%</b>	

Reason for change more than 25%:

The ratio has been decreased from 0.82 in 31st March 2019 to 0.55 in 31st March 2020 mainly due to increase in earnings and repayment of borrowings during the year.

The ratio has been decreased from 0.55 in 31st March 2020 to 0.23 in 31st March 2021 mainly due to increase in earnings and repayment of borrowings during the year.

**c) Debt Service Coverage Ratio = Earnings available for debt services divided by Total interest and principal repayments**

Particulars	31st December 2021	31st March 2021	31st March 2020	31st March 2019
<b>Profit after tax</b>	<b>1,223.36</b>	<b>923.86</b>	<b>626.42</b>	<b>695.97</b>
<b>Add: Non cash operating expenses and finance cost</b>				
-Depreciation and amortization	271.66	372.59	354.42	300.96
-Interest	34.42	72.77	170.84	171.05
-Loss/(Profit) on sale of fixed assets	0.93	8.23	(62.69)	(0.20)
-Fixed assets written-off	-	0.84	0.73	3.97
	<b>307.01</b>	<b>454.43</b>	<b>463.30</b>	<b>475.78</b>
<b>Earnings available for debt services</b>	<b>1,530.37</b>	<b>1,378.29</b>	<b>1,089.72</b>	<b>1,171.75</b>
Interest & Lease payments	95.17	161.46	255.50	240.03
Principal repayments	62.18	269.94	233.16	78.16
<b>Total Interest and principal repayments</b>	<b>157.35</b>	<b>431.40</b>	<b>488.66</b>	<b>318.19</b>
<b>Ratio</b>	<b>9.73</b>	<b>3.19</b>	<b>2.23</b>	<b>3.68</b>
<b>% Change from previous period / year</b>	<b>204.42%</b>	<b>43.27%</b>	<b>(39.44)%</b>	

**Uniparts India Limited****Annexure V - Notes to the Restated Consolidated Financial Information****(All amounts are in Rs. million, unless stated otherwise)**

Reason for change more than 25%:

The ratio has been decreased from 3.68 in 31st March 2019 to 2.23 in 31st March 2020 mainly due to repayment of borrowings during the year.

The ratio has been increased from 2.23 in 31st March 2020 to 3.19 in 31st March 2021 mainly due to increase in earnings, decrease in finance cost and repayment of borrowings during the year.

The ratio has been increased from 3.19 in 31st March 2021 to 9.73 in 31st December 2021 mainly due to increase in earnings, decrease in finance cost during the period.

**d) Return on Equity Ratio / Return on Investment Ratio = Net profit after tax divided by Average Equity**

<b>Particulars</b>	<b>31st December 2021</b>	<b>31st March 2021</b>	<b>31st March 2020</b>	<b>31st March 2019</b>
Net profit after tax*	1,223.36	923.86	626.42	695.97
Average Equity	6,126.72	5,117.73	4,430.73	3,937.59
<b>Ratio</b>	<b>19.97%</b>	<b>18.05%</b>	<b>14.14%</b>	<b>17.68%</b>
<b>% Change from previous period / year</b>	<b>10.61%</b>	<b>27.68%</b>	<b>(20.01)%</b>	

\*Net profit after tax for the nine months period ended 31st December 2021 was not annualized.

Reason for change more than 25%:

The ratio has been increased from 14.14% in 31st March 2020 to 18.05% in 31st March 2021 mainly due to increase in earnings and decrease in finance cost during the year.

**e) Inventory Turnover Ratio = Cost of goods sold divided by Average inventory**

<b>Particulars</b>	<b>31st December 2021</b>	<b>31st March 2021</b>	<b>31st March 2020</b>	<b>31st March 2019</b>
Cost of goods sold*	2,741.07	3,528.90	3,287.86	3,723.24
Average inventory	3,968.25	3,459.98	3,601.92	3,358.23
Inventory Turnover Ratio	<b>0.69</b>	<b>1.02</b>	<b>0.91</b>	<b>1.11</b>
<b>% Change from previous period / year</b>	<b>(32.27)%</b>	<b>11.73%</b>	<b>(17.67)%</b>	

\*Cost of goods sold for the nine months period ended 31st December 2021 was not annualized.

Reason for change more than 25%:

No material change in the inventory turnover ratio, on annualised basis for 31st December 2021.

**Uniparts India Limited**

**Annexure V - Notes to the Restated Consolidated Financial Information**

(All amounts are in Rs. million, unless stated otherwise)

**f) Trade Receivables turnover ratio = Net Credit Sales divided by Average trade receivables**

<b>Particulars</b>	<b>31st December 2021</b>	<b>31st March 2021</b>	<b>31st March 2020</b>	<b>31st March 2019</b>
Net Credit Sales*	8,760.24	8,917.63	8,907.36	10,399.68
Average trade receivables	1,644.53	1,451.84	1,340.97	1,305.29
<b>Ratio</b>	<b>5.33</b>	<b>6.14</b>	<b>6.64</b>	<b>7.97</b>
<b>% Change from previous period / year</b>	<b>(13.28)%</b>	<b>(7.53)%</b>	<b>(16.63)%</b>	

\*Net Credit Sales for the nine months period ended 31st December 2021 was not annualized.

Reason for change more than 25%: Not applicable

**g) Trade payables turnover ratio = Net Credit Purchases divided by Average trade payables**

<b>Particulars</b>	<b>31st December 2021</b>	<b>31st March 2021</b>	<b>31st March 2020</b>	<b>31st March 2019</b>
Net Credit Purchases	3,859.54	3,387.98	3,144.96	4,423.16
Average trade payables	880.78	713.87	612.59	786.92
<b>Ratio</b>	<b>4.38</b>	<b>4.75</b>	<b>5.13</b>	<b>5.62</b>
<b>% Change from previous period / year</b>	<b>(7.67)%</b>	<b>(7.56)%</b>	<b>(8.66)%</b>	

\*Net Credit Purchases for the nine months period ended 31st December 2021 was not annualized.

Reason for change more than 25%: Not applicable

**h) Net capital Turnover Ratio = Revenue from operations by Working capital whereas working capital= current assets - current liabilities**

<b>Particulars</b>	<b>31st December 2021</b>	<b>31st March 2021</b>	<b>31st March 2020</b>	<b>31st March 2019</b>
Revenue from operations*	8,808.92	9,031.42	9,072.20	10,605.66
Working capital	3,952.47	2,943.92	1,927.73	1,648.36
<b>Ratio</b>	<b>2.23</b>	<b>3.07</b>	<b>4.71</b>	<b>6.43</b>
<b>% Change from previous period / year</b>	<b>(27.35)%</b>	<b>(34.81)%</b>	<b>(26.86)%</b>	

\*Revenue from operations for the nine months period ended 31st December 2021 was not annualized.

**Uniparts India Limited****Annexure V - Notes to the Restated Consolidated Financial Information****(All amounts are in Rs. million, unless stated otherwise)**

Reason for change more than 25%:

The ratio has been decreased from 6.43 in 31st March 2019 to 4.71 in 31st March 2020 mainly due to decrease in current liability on account of repayment of borrowings.

The ratio has been decreased from 4.71 in 31st March 2020 to 3.07 in 31st March 2021 mainly due to increase in trade receivables and decrease in current liability on account of repayment of borrowings.

The ratio has been decreased from 3.07 in 31st March 2021 to 2.23 in 31st December 2021 mainly due to increase current assets i.e. majorly in inventories and decrease in current liability on account of repayment of borrowings.

**i) Net profit ratio = Net profit after tax divided by Revenue from operations**

<b>Particulars</b>	<b>31st December 2021</b>	<b>31st March 2021</b>	<b>31st March 2020</b>	<b>31st March 2019</b>
Net profit after tax*	1,223.36	923.86	626.42	695.97
Revenue from operations*	8,808.92	9,031.42	9,072.20	10,605.66
<b>Ratio</b>	<b>13.89%</b>	<b>10.23%</b>	<b>6.90%</b>	<b>6.56%</b>
<b>% Change from previous period / year</b>	<b>35.76%</b>	<b>48.15%</b>	<b>5.22%</b>	

\* Amount for the nine months period ended 31st December 2021 were not annualized.

Reason for change more than 25%:

The ratio has been increased from 6.90% in 31st March 2020 to 10.23% in 31st March 2021 mainly due to increase in earnings during the year.

The ratio has been increased from 10.23% in 31st March 2021 to 13.89% in 31st December 2021 mainly due to increase in earnings during the period.

**Uniparts India Limited**

**Annexure V - Notes to the Restated Consolidated Financial Information**

(All amounts are in Rs. million, unless stated otherwise)

**j) Return on Capital employed = Earnings before interest and taxes(EBIT) divided by Capital Employed**

<b>Particulars</b>	<b>31st December 2021</b>	<b>31st March 2021</b>	<b>31st March 2020</b>	<b>31st March 2019</b>
Profit before tax* (A)	1,699.54	1,185.60	744.03	915.54
Finance costs* (B)	42.28	81.07	179.65	181.98
<b>EBIT (C) = (A)+(B)</b>	<b>1,741.82</b>	<b>1,266.67</b>	<b>923.68</b>	<b>1,097.52</b>
Total assets (D) #	10,072.53	8,932.70	8,987.47	9,584.37
Intangible assets (E) #	652.15	644.24	672.43	656.01
Total liabilities (F) #	3,412.91	3,338.89	4,345.82	5,364.56
<b>Tangible Net Worth (G)=(D)-(E)-(F)</b>	<b>6,007.47</b>	<b>4,949.57</b>	<b>3,969.22</b>	<b>3,563.80</b>
Total debt (H) #	1,277.85	1,169.59	2,395.41	3,305.35
Deferred tax liability (net) (I)	242.47	275.61	241.48	273.55
<b>Capital Employed (J)=( G)+(H)+(I)</b>	<b>7,527.79</b>	<b>6,394.77</b>	<b>6,606.11</b>	<b>7,142.70</b>
<b>Ratio (C)/(J)</b>	<b>23.14%</b>	<b>19.81%</b>	<b>13.98%</b>	<b>15.37%</b>
<b>% Change from previous period / year</b>	<b>16.81%</b>	<b>41.67%</b>	<b>(9.00)%</b>	

\* Amount for the nine months period ended 31st December 2021 were not annualized.

# Total debt = Borrowings - Cash & cash equivalents

Reason for change more than 25%:

The ratio has been increased from 13.98% in 31st March 2020 to 19.81% in 31st March 2021 mainly due to increase in earnings and decrease in finance cost during the year.

## **Uniparts India Limited**

### **Annexure V - Notes to the Restated Consolidated Financial Information**

**(All amounts are in Rs. million, unless stated otherwise)**

#### **45. Treatment in respect of Insurance, Fire and Other Claims**

##### **Related to India Plants**

During the year ended 31st March 2020, incident of fire had occurred in the two plants and the claims amounting to Rs. 10.83 millions have been settled and recognised during the year ended 31st March 2021. The expenses incurred in this regard have been charged directly under various heads of related expenses.

##### **Related to USA Plant**

The step-down subsidiary had an incident of fire in the plant and suffered property damages during the year ended 31st March 2020. The insurance claim for the same has been settled during the year ended 31st March 2021. During the year ended 31st March 2021, the step-down subsidiary incurred expenses related to fire amounting to Rs. 75.25 millions (31st March 2020: Rs. 218.34 million) and has recognized insurance claim recoveries amounting to Rs. 238.36 million (31st March 2020: Rs. 231.79 million). As at 31st March 2021, the step-down subsidiary has receivables for insurance claim amounting to Rs. Nil (31st March 2020: Rs. 60.29 million) and advance insurance claim recovery amounting to Rs. Nil (31st March 2020: Rs. 49.24 million).

#### **46. Paycheck Protection Program ("PPP")**

During the year ended 31st March 2021, Uniparts USA Limited one of the subsidiary of the company has received a loan amounting to Rs. 160.87 millions from JPMorgan Chase, N.A. (the "Loan") pursuant to the Paycheck Protection Program ("PPP") under the Coronavirus Aid, Relief and Economic Security Act (the "CARES Act"), which was enacted on 27th March 2020. The company has received forgiveness as per SBA guidelines for the said PPP loan during the current period based on the "Qualifying expenses" incurred during the utilization period. The qualifying expenses incurred in relation to the claim of the said loan have been accounted for under the respective expense heads including cost of goods sold, selling, general and administration expenses etc. Following the guidance of IAS 20 in line with Ind AS 20 (Accounting for Government Grants and disclosure of Government Assistance), the loans proceeds have been shown under the head "Other income" amounting to Rs. Nil for the period ended 31st December 2021 and Rs. 160.87 millions for the year ended 31st March 2021.

#### **47. Employee retention credit ("ERC")**

During the period ended 31st December 2021, Uniparts Olsen Inc. the Step down Subsidiary of the company has received benefits under the ERC scheme, established under the CARES Act, which is intended to help businesses to retain their workforces and to avoid layoffs during the coronavirus pandemic. The company has received amount of Rs. 11.09 million on account of ERC refund, which have been shown under the head "Other income" in the statement of profit and loss.

**Uniparts India Limited**  
**Annexure V - Notes to the Restated Consolidated Financial Information**  
**(All amounts are in Rs. million, unless stated otherwise)**

**48. Fund raising expenses**

The Company had incurred various expenses, also on behalf of selling shareholders for filing of DRHP for offer for sale of shares and fresh equity for furtherance of business during the year ended 31st March 2019 and 31st March 2020. The balance of such irrecoverable costs has been written off during the year ended 31st March, 2021.

49. The shareholder of Uniparts Europe B.V. in their Extraordinary General meeting have decided to proceed for the voluntary liquidation of the company and started the process of windup with immediate effect. The management is of the view that the Uniparts Europe B.V. will meets all its obligations and no impairment is required as on 31st December 2021.

**50. Impact of COVID-19 on financial statements**

In view of the pandemic relating to COVID - 19, the Company has considered internal and external information and has performed an analysis based on current estimates while assessing the recoverability of investments, property plant and equipment, right-of-use assets, trade receivables, other current and financial assets, for any possible impact on the financial statements. The Company has also assessed the impact of this whole situation on its capital and financial resources, profitability, liquidity position, internal financial reporting controls etc. and is of the view that based on its present assessment this situation does not materially impact the Consolidated financial statements.

However, the actual impact of COVID - 19 on the financial statements may differ from that estimated due to unforeseen circumstances and the Company will continue to closely monitor any material changes to future economic conditions.

As per our report of even date  
**For Rakesh Banwari & Co.**  
Chartered Accountants  
Firm Regn. No.009732N

**Rakesh Aggarwal**  
(Proprietor)  
Membership No. 088193

**Place : New Delhi**  
**Date : 22 March 2022**

For and on behalf of Board of Directors of  
**Uniparts India Limited**

**Gurdeep Soni**  
(Chairman & Managing Director) [DIN: 00011478]  
**Paramjit Singh Soni**  
(Vice Chairman & Director) [DIN: 00011616]

**Munish Sapra**  
(Chief Financial Officer)  
**Jatin Mahajan**  
(Company Secretary) [FCS: 6887]

**Uniparts India Limited****Annexure VI - Summary of Restatement Adjustments****(All amounts are in Rs. million, unless stated otherwise)**

Summarized below are the restatement adjustments made to the Restated Consolidated Financial Statements for the period ended 31st December 2021 and for the years ended 31st March 2021, 31st March 2020 and 31st March 2019 and their impact on equity and the profit of the Group.

**Part A: Statement of Adjustments to Restated Consolidated Financial Statements**

Reconciliation between audited profit and restated profit

<b>Particulars</b>	<b>Note</b>	<b>For the period ended 31st December 2021</b>	<b>For the year ended 31st March 2021</b>	<b>For the year ended 31st March 2020</b>	<b>For the year ended 31st March 2019</b>
Profit for the period/year (as per audited consolidated financial statements) (A)		1,234.69	912.13	627.53	700.23
<b>Restatement adjustments:</b>					
Prior Period Tax Adjustment	1	11.33	(11.73)	1.11	0.65
On account of adoption of Ind AS 116:	2				
- Depreciation		-	-	-	63.15
- Finance cost		-	-	-	10.70
- Lease expenses		-	-	-	(68.98)
		<b>11.33</b>	<b>(11.73)</b>	<b>1.11</b>	<b>5.52</b>
Deferred Tax impact on restatement adjustment		-	-	-	(1.26)
<b>Total impact on account of restatement adjustments (B)</b>		<b>11.33</b>	<b>(11.73)</b>	<b>1.11</b>	<b>4.26</b>
<b>Profit for the period/year as per Restated Consolidated Summary Statement of Profit and loss (A-B)</b>		<b>1,223.36</b>	<b>923.86</b>	<b>626.42</b>	<b>695.97</b>



**Uniparts India Limited****Annexure VI - Summary of Restatement Adjustments****(All amounts are in Rs. million, unless stated otherwise)****Reconciliation between audited total equity and restated total equity**

<b>Particulars</b>	<b>Note</b>	<b>As at 31st December 2021</b>	<b>As at 31st March 2021</b>	<b>As at 31st March 2020</b>	<b>As at 31st March 2019</b>
Total equity (as per audited consolidated financial statements) (A)		6,659.62	5,582.48	4,642.05	4,228.88
<b>Restatement adjustments:</b>					
Prior Period Tax Adjustment	1	-	11.33	(0.40)	0.71
On account of adoption of Ind AS 116:	2	-	-	-	(11.04)
Deferred Tax impact on above adjustment		-	-	-	1.26
<b>Total impact on account of restatement adjustments (B)</b>		<b>-</b>	<b>11.33</b>	<b>(0.40)</b>	<b>(9.07)</b>
<b>Total equity as per Restated Consolidated Summary Statement of Assets and Liabilities (A+B)</b>		<b>6,659.62</b>	<b>5,593.81</b>	<b>4,641.65</b>	<b>4,219.81</b>

**Note 1:**

The prior period taxes are adjusted for the period to which actually relates. Accordingly;

- Tax Expense for the period ended 31st December 2021 is increased by Rs. 11.33 million with corresponding impact on other equity.
- Tax Expense for the year ended 31st March 2021 is decreased by Rs. 11.73 million with corresponding impact on other equity.
- Tax Expense for the year ended 31st March 2020 is increased by Rs. 1.11 million with corresponding impact on other equity.
- Tax Expense for the year ended 31st March 2019 is increased by Rs. 0.65 million with corresponding impact on other equity.

## **Uniparts India Limited**

### **Annexure VI - Summary of Restatement Adjustments**

**(All amounts are in Rs. million, unless stated otherwise)**

#### **Note 2:**

Ind AS 116 - "Leases", which is mandatory w.e.f. 1st April 2019, has replaced existing Ind AS 17 - "Leases". The Group has applied the modified retrospective approach on transition w.e.f. 1st April 2019.

However for the restatement purpose, modified retrospective approach has been applied w.e.f 1st April 2018. The effect of implementing Ind AS 116 is as

- Right of use (ROU) asset recognised on 1st April 2018 is Rs. 528.86 million (including reclassification of leasehold land of Rs. 312.43 million (gross))
- Lease liability recognised on 1st April 2018 is Rs. 227.87 million
- Depreciation and amortisation expenses are higher by Rs. 63.15 million in FY 18-19
- Finance costs are higher by Rs. 10.70 million in FY 18-19
- Other expenses are lower by Rs. 68.98 million in FY 18-19
- Net Deferred tax liability are lower by Rs. 1.26 million

As required by the Guidance Note, an adjustment of Rs. 11.66 million has been recorded in retained earnings as at 1st April 2019 with a corresponding impact in Right-of-use assets and deferred tax liabilities (net) to reflect and carry forward the opening balance in these line items as per the Audited Consolidated financial statements for year-ended 31st March 2020.

#### **Material regrouping/reclassification**

Appropriate regrouping/reclassification have been made in the Restated Consolidated Statement of Assets and Liabilities, Restated Consolidated Statement of Profit and Loss and Restated Consolidated Statement of Cash flows, wherever required, by reclassification of the corresponding items of income, expenses, assets, liabilities and cash flows, in order to bring them in line with the accounting policies and classification as per the Restated Audited Consolidated Financial Statements for the nine months period ended 31st December 2021 prepared in accordance with Schedule III (Division II) of the Act, requirements of Ind AS 1 - 'Presentation of financial statements' and other applicable Ind AS principles and the requirements of the Securities and Exchange Board of India (Issue of Capital & Disclosure Requirements) Regulations, 2018, as amended.

#### **Part B :- Reconciliation of Right-of-use assets, deferred tax liability, lease liability, foreign currency translation reserve & retained earning as per audited consolidated financial statements with Restated Consolidated Financial Information as at 31st March 2019:**

The Group has followed the same accounting policy choices (transition options as per Ind AS 116) as adopted on 1st April 2019 for transition to Ind AS 116, while preparing the Restated Consolidated Financial Information for each of the year ended 31st March 2021, 31st March 2020 and 31st March 2019. As specified in the Guidance Note, the equity balance computed under Restated Consolidated Financial Information for the year ended 31st March 2019 and equity balance as per audited consolidated financial statements on 1st April 2019, differs due to restatement adjustments made for the year ended 31st March 2019. Accordingly, following balances as at 31st March 2019 of the Restated Consolidated Financial Information has not been carried forward to opening balance sheet as at 1st April 2019.

**Uniparts India Limited**

**Annexure VI - Summary of Restatement Adjustments**

(All amounts are in Rs. million, unless stated otherwise)

<b>Particulars</b>	<b>Right-of-use assets</b>	<b>Deferred Tax Liability (Net)</b>	<b>Lease liability</b>	<b>Foreign Currency Translation Reserve</b>	<b>Retained earnings</b>
Balance as per Restated Consolidated Financial Information as at 31st March 2019	749.18	273.55	462.93	(710.14)	3,532.69
Prior Period Adjustment	-	-	-	-	(0.71)
<b>Balance as per Restated Consolidated Financial Information as at 31st March 2019 post prior period adjustment</b>	<b>749.18</b>	<b>273.55</b>	<b>462.93</b>	<b>(710.14)</b>	<b>3,531.98</b>
Add/(Less): Adjustment on account of transition to Ind AS 116 (including corresponding deferred tax)	(749.18)	4.65	(462.93)	(1.88)	11.66
<b>Balance as at 31st March 2019 as per audited consolidated financial statements for the year ended 31st March 2019</b>	<b>-</b>	<b>278.20</b>	<b>-</b>	<b>(712.02)</b>	<b>3,543.64</b>

**Uniparts India Limited**  
**Annexure VI - Summary of Restatement Adjustments**  
**(All amounts are in Rs. million, unless stated otherwise)**

**Part C :- Non adjusting items**

**i) Uniparts India Limited**

**Auditor's Comments in Annexure to Auditors' Report for the year ended March 31, 2021:**

**Clause vii(b) of the CARO 2016 Order**

According to the information and explanations given to us and the records of the Company examined by us, there are no material dues of duty of customs as at March 31, 2021 which have not been deposited on account of any dispute. However, according to information and explanation given to us, the following dues to income tax, goods and service tax and value added tax have not been deposited by the Company on accounts of disputes:

<b>Name of the statute</b>	<b>Nature of Dues</b>	<b>Amount</b>	<b>Period to which the amount relates</b>	<b>Forum where the dispute is pending</b>
GST Act, 2017	IGST	0.17	F.Y. 2019-20	Asst. Commissioner of GST
UP VAT Act, 2005	Sales Tax	0.13	F.Y. 2017-18	Dy. Commissioner of VAT
UP VAT Act, 2005	Sales Tax	0.24	F.Y. 2016-17	Dy. Commissioner of VAT
GST Act, 2017	IGST	0.19	F.Y. 2018-19	Asst. Commissioner of GST
UP VAT Act, 2005	Sales Tax	0.27	F.Y. 2015-16	Dy. Commissioner of VAT
UP VAT Act, 2005	Sales Tax	0.74	F.Y. 2012-13	Dy. Commissioner of VAT
UP VAT Act, 2005	Sales Tax	0.16	F.Y. 2011-12	Dy. Commissioner of VAT
UP VAT Act, 2005	Sales Tax	0.40	F.Y. 2013-14	Dy. Commissioner of VAT
UP VAT Act, 2005	Sales Tax	0.39	F.Y. 2014-15	Dy. Commissioner of VAT
Central Excise and Customs Act, 1944	Custom Tax	1.60	F.Y. 2008-09	High Court of Hyderabad
Income Tax Act, 1961	Income Tax	0.16	A.Y. 2010-11	Commissioner of Income Tax (Appeals)
Income Tax Act, 1961	Income Tax	0.03	A.Y. 2012-13	Commissioner of Income Tax (Appeals)
Income Tax Act, 1961	Income Tax	40.13	A.Y. 2017-18	Commissioner of Income Tax (Appeals)
Income Tax Act, 1961	Income Tax	21.12	A.Y. 2019-20	Asst. Commissioner of Income Tax
Income Tax Act, 1961	Income Tax	0.37	A.Y. 2018-19	Asst. Commissioner of Income Tax
Central Excise Act, 1944	Excise Duty	0.14	F.Y. 2004-09	Asst. Commissioner of Central Excise
Central Excise Act, 1944	Excise Duty	0.01	F.Y. 2009-10	Asst. Commissioner of Central Excise
Central Excise Act, 1944	Excise Duty	0.01	F.Y. 2010-11	Asst. Commissioner of Central Excise
Central Excise Act, 1944	Excise Duty	0.03	F.Y. 2011-12	Asst. Commissioner of Central Excise
Central Excise Act, 1944	Excise Duty	0.02	F.Y. 2012-13	Asst. Commissioner of Central Excise

**Uniparts India Limited****Annexure VI - Summary of Restatement Adjustments****(All amounts are in Rs. million, unless stated otherwise)****Auditor's Comments in Annexure to Auditors' Report for the year ended March 31, 2020:**

According to the information and explanations given to us and the records of the Company examined by us, there are no material dues of duty of customs as at March 31, 2020 which have not been deposited on account of any dispute. However, according to information and explanation given to us, the following dues to income tax, goods and service tax and value added tax have not been deposited by the Company on accounts of disputes:

<b>Name of the statute</b>	<b>Nature of Dues</b>	<b>Amount</b>	<b>Period to which the amount relates</b>	<b>Forum where the dispute is pending</b>
GST Act, 2017	IGST	0.17	F.Y. 2019-20	Asst. Commissioner of GST
UP VAT Act, 2005	Sales Tax	0.13	F.Y. 2017-18	Dy. Commissioner of VAT
UP VAT Act, 2005	Sales Tax	0.24	F.Y. 2016-17	Dy. Commissioner of VAT
GST Act, 2017	IGST	0.19	F.Y. 2018-19	Asst. Commissioner of GST
UP VAT Act, 2005	Sales Tax	0.27	F.Y. 2015-16	Dy. Commissioner of VAT
UP VAT Act, 2005	Sales Tax	0.74	F.Y. 2012-13	Dy. Commissioner of VAT
UP VAT Act, 2005	Sales Tax	0.16	F.Y. 2011-12	Dy. Commissioner of VAT
UP VAT Act, 2005	Sales Tax	0.40	F.Y. 2013-14	Dy. Commissioner of VAT
UP VAT Act, 2005	Sales Tax	0.39	F.Y. 2014-15	Dy. Commissioner of VAT
AP VAT Act, 2005	Commercial Tax	9.23	F.Y. 2014-15	Dy. Commissioner of VAT
Central Excise and Customs Act, 1944	Customs Tax	1.60	F.Y. 2008-09	High Court of Hyderabad
Income Tax Act, 1961	Income Tax	0.16	A.Y. 2010-11	Commissioner of Income Tax (Appeals)
Income Tax Act, 1961	Income Tax	0.03	A.Y. 2012-13	Commissioner of Income Tax (Appeals)
Income Tax Act, 1961	Income Tax	40.13	A.Y. 2017-18	Commissioner of Income Tax (Appeals)

**Uniparts India Limited****Annexure VI - Summary of Restatement Adjustments****(All amounts are in Rs. million, unless stated otherwise)****Auditor's Comments in Annexure to Auditors' Report for the year ended March 31, 2019:**

According to the information and explanations given to us and the records of the Company examined by us, there are no material dues of duty of customs as at March 31, 2019 which have not been deposited on account of any dispute. However, according to information and explanation given to us, the following dues to income tax, goods and service tax and value added tax have not been deposited by the Company on accounts of disputes:

Name of the statute	Nature of Dues	Amount	Period to which the amount relates	Forum where the dispute is pending
Finance Act, 1994	Service Tax	0.23	F.Y. 2012-13 to 2014-15	CESAT Allahabad
Customs Act, 1962	Customs Tax	1.60	F.Y. 2008-09	High Court of Hyderabad

**i) Gripwel Fasteners Private Limited****Auditor's Comments in Annexure to Auditors' Report for the year ended March 31, 2021:****Clause vii(b) of the CARO 2016 Order**

According to the information and explanations given to us and the records of the Company examined by us, there are no material dues of duty of customs as at March 31, 2021 which have not been deposited on account of any dispute. However, according to information and explanation given to us, the following dues to income tax, goods and service tax and value added tax have not been deposited by the Company on accounts of disputes:

Name of the statute	Nature of Dues	Amount	Period to which the amount relates	Forum where the dispute is pending
Income Tax Act, 1961	Income Tax	13.102	A.Y. 2019-20	Asst. Commissioner of Income Tax

**Uniparts India Limited**  
**Annexure VI - Summary of Restatement Adjustments**  
**(All amounts are in Rs. million, unless stated otherwise)**

**Auditor's Comments in Annexure to Auditors' Report for the year ended March 31, 2019:**

**Clause vii(b) of the CARO 2016 Order**

According to the information and explanations given to us and the records of the Company examined by us, there are no material dues of duty of customs as at March 31, 2019 which have not been deposited on account of any dispute. However, according to information and explanation given to us, the following dues to income tax, goods and service tax and value added tax have not been deposited by the Company on accounts of disputes:

<b>Name of the statute</b>	<b>Nature of Dues</b>	<b>Amount</b>	<b>Period to which the amount relates</b>	<b>Forum where the dispute is pending</b>
UP VAT Act, 2005	VAT	0.178	F.Y. 2015-16	Asst. Commissioner of VAT
GST Act, 2017	GST	0.315	F.Y. 2018-19	Asst. Commissioner of GST

As per our report of even date  
**For Rakesh Banwari & Co.**  
Chartered Accountants  
Firm Regn. No.009732N

**Rakesh Aggarwal**  
(Proprietor)  
Membership No. 088193

**Place : New Delhi**  
**Date : 22 March 2022**

For and on behalf of Board of Directors of  
**Uniparts India Limited**

**Gurdeep Soni**  
(Chairman & Managing Director) (Vice Chairman & Director)  
[DIN: 00011478] [DIN: 00011616]

**Munish Sapra**  
(Chief Financial Officer)

**Jatin Mahajan**  
(Company Secretary)  
[FCS: 6887]

## OTHER FINANCIAL INFORMATION

The audited standalone financial statements of our Company and its Material Subsidiaries as identified in accordance with the SEBI ICDR Regulations, for the year ended March 31, 2021, March 31, 2020, and March 31, 2019 (“**Standalone Financial Statements**”) are available at <https://unipartsgroup.com/investor-finance-annual.asp?links=inv1>. Our Company is providing a link to this website solely to comply with the requirements specified in the Securities and Exchange Board of India (Issue of Capital and Disclosure Requirement) Regulations, 2018. The Standalone Financial Statements do not constitute, (i) a part of this Draft Red Herring Prospectus; or (ii) a prospectus, a statement in lieu of a prospectus, an offering circular, an offering memorandum, an advertisement, an offer or a solicitation of any offer or an offer document to purchase or sell any securities under the Companies Act, 2013, the Securities and Exchange Board of India (Issue of Capital and Disclosure Requirement) Regulations, 2018, or any other applicable law in India or elsewhere in the world. The Standalone Financial Statements should not be considered as part of information that any investor should consider to subscribe for or purchase any securities of our Company or any of its subsidiaries, or any entity in which it or its shareholders have significant influence (collectively, the “**Group**”) and should not be relied upon or used as a basis for any investment decision. None of the Group or any of its advisors, nor any BRLMs or Selling Shareholders, nor any of their respective employees, directors, affiliates, agents or representatives accept any liability whatsoever for any loss, direct or indirect, arising from any information presented or contained in the Standalone Financial Statements, or the opinions expressed therein. The accounting ratios derived from Restated Financial Statements required to be disclosed under the SEBI ICDR Regulations are set forth below:

Particulars	For the nine months period ended December 31, 2021	For the year ended March 31, 2021	For the year ended March 31, 2020	For the year ended March 31, 2019
Earnings per Equity Share				
- Basic EPS (in ₹)	27.73	20.95	14.20	15.78
- Diluted EPS (in ₹)	27.11	20.47	13.88	15.42
RoNW %	18.37	16.52	13.50	16.49
NAV per Equity Share	147.55	123.94	102.84	93.50
EBITDA (in ₹ million)	2,013.48	1,639.26	1,278.10	1,398.48

For details of accounting ratios, see “*Financial Statements – Annexure V – Note 44*” on page 334 .



## CAPITALISATION STATEMENT

The following table sets forth our capitalisation derived from our Restated Financial Statements for the financial year ended and as at December 31, 2021, and as adjusted for the Offer. This table should be read in conjunction with “*Management’s Discussion and Analysis of Financial Condition and Results of Operations*”, “*Financial Statements*” and “*Risk Factors*” on pages 355, 212, and 27, respectively.

<i>(₹ in million, except ratios)</i>		
Particulars	Pre-Offer as at December 31, 2021	As adjusted for the proposed Offer <sup>(2)</sup>
<b>Total Borrowings</b>		
Current borrowings <sup>#</sup> (A)	1,335.33	[●]
Non-current borrowings (including current maturities of long-term borrowings) <sup>#</sup> (B)	74.25	[●]
<b>Total Borrowings (C)</b>	1,409.58	[●]
<b>Total Equity</b>		
Equity share capital	446.20	[●]
Other Equity <sup>#</sup>	6,213.42	[●]
Non-controlling interest	0.00	[●]
<b>Total Equity (D)</b>	6,659.62	[●]
<b>Ratio: Non-Current Borrowings</b> (including current maturities of long-term borrowings) / <b>Total Equity (B) / (D)</b>	0.01	[●]
<b>Ratio: Total Borrowings / Total Equity (C) / (D)</b>	0.20	[●]

Note:

1. The above has been derived from the Restated Financial Statements.
2. Our Company is proposing to offer the Equity Shares through an offer for sale by way of initial public offering. Hence, there will be no change in the shareholders' funds on account of this Offer.
3. The corresponding post Offer capitalization data for each of the amounts given in the above table is not determinable at this stage pending the completion of the book building process and hence the same have not been provided in the above statement.

# These terms shall carry the meaning as per Schedule III of the Companies Act.

## FINANCIAL INDEBTEDNESS

Our Company and Subsidiaries avail loans in the ordinary course of business for meeting their working capital and business requirements. Our Company and our Promoters also provide guarantees in relation to the loans availed by our Subsidiaries as and when required. Our Company has obtained the necessary consents required under the relevant loan documentation for undertaking activities, such as change in our board of directors, change in our capital structure, change in our shareholding pattern and change in our constitution.

The details of aggregate indebtedness of our Company and our Subsidiaries as on February 28, 2022 is provided below:

<i>(in ₹ million)</i>		
Category of Borrowing	Sanctioned Amount (to the extent applicable)	Principal amount outstanding as on February 28, 2022*
<b>Working Capital facilities</b>		
<b>Secured</b>		
Fund based	2,401.99	1,483.61
Non-fund based	0.40	-
Total (A)	2,402.39	1,483.61
<b>Unsecured</b>		
Fund based	160.00	-
Non-fund based	-	-
Total (B)	160.00	-
Total Working Capital facilities (A+B)	2,562.39	1,483.61
<b>Term Loan Facilities</b>		
<b>Secured (C1)</b>	185.32	62.77
<b>Unsecured (C2)</b>	-	-
Total term loan facilities (C=C1+C2)	185.32	62.77
<b>Total borrowings (A+B+C)</b>	<b>2,747.71</b>	<b>1,546.38</b>

*1USD=75.48; Source: www.fbil.org.in, as on February 28, 2022.*

*\* As certified by Rakesh Banwari & Co., Chartered Accountants, by way of their certificate dated April 25, 2022.*

### **Principal terms of the borrowings availed by the Company and Indian Subsidiaries:**

The details provided below are indicative and there may be additional terms, conditions and requirements under the various borrowing arrangements entered into by the Company and Indian Subsidiaries.

**Interest:** All the borrowings have a floating rate of interest.

**Prepayment Penalty:** Some of the facilities carry a pre-payment penalty of up to 2.00% on the pre-paid amount or on the outstanding amount, as applicable, or such other penalty as may be levied at the discretion of the lenders.

**Penal Interest:** The terms of the facilities prescribe penalties for delayed payment or default in the repayment obligations, delay in creation of the stipulated security or certain other specified obligations, which typically is 2.00% over and above the applicable interest rate.

**Validity/Tenor:** The tenor of the term loan availed is for 5 years and tenor of working capital facilities if for 180 days.

**Security:** In terms of the borrowings where security needs to be created, such security typically includes:

- Charge by way of hypothecation on movable fixed assets, book debts, inventories, all other current assets, both present and future;
- Charge by way of mortgage on the B-208, A1&A2, Phase II, Noida, Uttar Pradesh, India facility;
- Corporate guarantees are at times provided by the Company for loans availed by its Subsidiaries in India and at times by the Indian Subsidiaries for loans availed by the Company.

**Repayment:** The term loans availed by our Company are typically repayable in monthly instalments and the working capital facilities are typically repayable on and before the due date.

**Key Covenants:** Several of the financing arrangements entail various restrictive covenants and conditions

restricting certain corporate actions, and we are required to take the prior approval of the respective lender before carrying out such actions, including for:

- any change in the capital structure;
- undertaking or implementing a new scheme of expansion or an allied line of business or manufacture;
- any change in the management setup;
- permitting any transfer of controlling interest;
- any alteration in the Memorandum of Association or Articles of Association;
- cross defaults or cross accelerations;
- any withdrawal of the capital invested in the business by the proprietor/ Directors of our Company during the currency of the loan facility;
- entering into borrowing arrangements either secured or unsecured with any other bank, financial institution, company or person; and
- undertaking any guarantee obligations on behalf of any other company (including group companies).

Please note that the abovementioned list is indicative and there may be additional restrictive covenants and conditions where we may be required to take prior approval of respective lender under the various borrowing arrangements entered into by us.

***Events of Default:*** In terms of borrowing arrangements for the facilities availed, the occurrence of any of the following, among others, constitute an event of default:

- change in ownership, management, and/or control without prior written consent of the lender;
- non-Payment of instalment/ interest within the stipulated time;
- representations or warranties found to be untrue or misleading when made;
- our Company ceasing or threatening to cease or carrying on its business;
- commission of an act of bankruptcy or filing of an application in relation to insolvency or bankruptcy against our Company;
- breach in performance of any other obligation, covenant or undertaking, under or in connection with the facilities, guarantee or security;
- bankruptcy, insolvency, liquidation, reorganization or winding up of our Company or appointment of a liquidator;
- failure to comply with financial covenants;
- inadequate security or insurance or non-creation of any security or failure of our Company to comply with any security stipulation; and
- any other event or material change which may have a material adverse effect on the lenders.

***Consequences of occurrence of events of default:*** In terms of our borrowing arrangements for the facilities availed, upon the occurrence of events of default, our lenders may:

- terminate the sanctioned facilities;
- seek immediate repayments of the facilities;
- suspend further access/drawals;
- enforce their security interest which includes, among others, taking possession and/or transfer of the assets to such other third parties by way of lease, leave and license, sale or otherwise;
- review the management setup/organization of our Company and may require to restructure, if necessary;
- exercise all other remedies as available under applicable law.

This is an indicative list and there may be additional terms that may require the consent of the relevant lender, the breach of which may amount to an event of default under various borrowing arrangements entered into by us, and the same may lead to consequences other than those stated above. For further information, see “***Risk Factors - A failure to comply with financial and other restrictive covenants imposed on us under our financing agreements may cause us to default on these agreements, which may adversely affect our ability to conduct our business and operations***” on page 38.

**Principal terms of the borrowings availed by our foreign Subsidiaries:**

The details provided below are indicative and there may be additional terms, conditions and requirements under the various borrowing arrangements entered into by our foreign Subsidiaries.

**Interest:** All the borrowings have a floating rate of interest.

**Prepayment Penalty:** The borrowings typically don't have any prepayment penalty. However, 0.25% each year is payable for unused line of credit.

**Security:** There is a first priority lien on all the business assets and all proceeds. Also, Uniparts USA Limited has secured the debt of Uniparts Olsen Inc and vice versa.

**Key Covenants:** The key covenants in the facilities are as follows:

1. There are limits on additional borrowing;
2. The minimum fixed charge coverage ratio should be higher than 1:2; and
3. The maximum funded debt to EBITDA ratio should be less than 3.

**Events of default:** In terms of the borrowing arrangements for the facilities availed, the occurrence of any of the following, among others, constitute an event of default:

1. Non-compliance of the underlying agreement;
2. Default in repayment;
3. Any breach in pension payment;
4. If the borrower becomes insolvent;
5. Appointment of any custodian/ receiver/ trustee; and
6. Any liquidation, merger, consolidation, selling of material part of assets.

**Consequences of events of default:** In terms of the borrowing arrangements for the facilities availed, upon the occurrence of events of default, there will be a penal interest of 3% above the adjusted LIBOR rate.

## MANAGEMENT'S DISCUSSION AND ANALYSIS OF FINANCIAL CONDITION AND RESULTS OF OPERATIONS

The following discussion of our financial condition and results of operations should be read in conjunction with our “**Restated Financial Statements**” on page 212. Unless otherwise indicated or the context otherwise requires, the financial information for Fiscal 2019, 2020 and 2021 and the nine months ended December 31, 2021 included herein is derived from the Restated Financial Statements, included in this Draft Red Herring Prospectus, which have been derived from our audited financial statements and restated in accordance with the SEBI ICDR Regulations and the Guidance Note on Reports in Company Prospectuses (Revised 2019) issued by the ICAI, as amended from time to time, which differ in certain material respects from IFRS, U.S. GAAP and GAAP in other countries. For further information, see “**Financial Statements**” on page 212.

Unless otherwise indicated or the context otherwise requires, in this section, references to “the Company” or “our Company” are to Uniparts India Limited on a standalone basis, and references to “the Group”, “we”, “us”, “our”, are to Uniparts India Limited on a consolidated basis.

Unless otherwise indicated, industry and market data used in this section has been derived from industry publications, in particular, the report titled “**Global Market Assessment of 3PL and PMP Products in Agriculture and Construction Equipment**” dated April, 2022 (the “**CRISIL Report**”), prepared and issued by CRISIL Limited appointed on December 15, 2021, and exclusively commissioned by and paid for by us in connection with the Offer. A copy of the CRISIL Report is available on the website of our Company at [www.unipartsgroup.com/ipo-industry-reports.asp?links=inv52](http://www.unipartsgroup.com/ipo-industry-reports.asp?links=inv52). There are no parts, data or information (which may be relevant for the proposed issue), that has been left out or changed in any manner. Unless otherwise indicated, financial, operational, industry and other related information derived from the CRISIL Report and included herein with respect to any particular year refers to such information for the relevant calendar year. For more information, see “**Risk Factors – Industry information included in this Draft Red Herring Prospectus has been derived from an industry report prepared by CRISIL Limited exclusively commissioned and paid for by us for such purpose.**” on page 34. Also see, “**Certain Conventions, Presentation of Financial, Industry and Market Data and Currency of Presentation – Industry and Market Data**” on page 15.

### OVERVIEW

We are a global manufacturer of engineered systems and solutions and are one of the leading suppliers of systems and components for the off-highway market in the agriculture and construction, forestry and mining (“**CFM**”) and aftermarket sectors on account of our presence across over 25 countries (*Source: CRISIL Report*). We are a concept-to-supply player for precision products for off-highway vehicles (“**OHVs**”) with presence across the value chain. Our product portfolio includes core product verticals of 3-point linkage systems (“**3PL**”) and precision machined parts (“**PMP**”) as well as adjacent product verticals of power take off (“**PTO**”), fabrications and hydraulic cylinders or components thereof. We have a leading presence in the manufacture of 3PL and PMP products globally on account of us serving some of the largest global companies (*Source: CRISIL Report*). Most of our products are structural and load bearing parts of the equipment and are subject to strict tolerances, specifications and process controls. A series of precision engineering process steps converge in to manufacturing of these products. We had an estimated 14.45% market share\* of the global 3PL market in Fiscal 2021 in terms of value and an estimated 5.87% market share\*\* in the global PMP market in the CFM sector in Fiscal 2021 in terms of value. We also cater to the aftermarket segment especially for 3PL product range. We provide replacements of 3PL parts to organized aftermarket retailers and distributors in North America, Europe, South Africa and Australia.

\* Computed as our 3PL sales in Fiscal 2021 (being USD 45.15 million) divided by the 3PL median market size for calendar year 2020 (being USD 312.5 million) (as per the CRISIL Report).

\*\* Computed as our PMP sales in Fiscal 2021 (being USD 30.52 million) divided by the PMP median market size for calendar year 2020 (being USD 520.0 million) (as per the CRISIL Report).

A brief description of the core products we manufacture is set out below:

**3PL:** The 3-PL systems consist of different assemblies that are attached to an agricultural tractor. It forms a group of assemblies allowing attaching an implement like a plough to the tractor at 3 coupling points. (*Source: CRISIL Report*) The systems are engineered customised to each tractor model and region in which the tractor is used as the specifications vary from region to region. These systems are subject to validation and have to comply with international standards.



**PMP:** PMP is a group of products that are components requiring stringent material and manufacturing specifications and controls. These include among others, precision machined components such as pins, bushes and bosses used in articulated joints. (Source: CRISIL Report) These are structural and load bearing parts of the equipment and are subject to strict tolerances, specifications and process controls. The product varies in design and technical specification between different applications. The number of SKUs are high and varied in this product category.

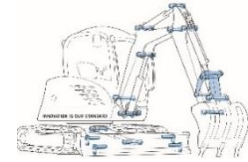

The world market for 3PL was between USD 305 million and USD 320 million in 2020 and is expected to grow at nearly 6% and 8% between 2020 – 2025, buoyed by robust growth in tractor production volumes in North America, India and Europe, steady growth in China and Japan. A major driver of 3PL demand is tractors and the demand for 3PL is set to grow at a steady, healthy pace. Although India and China have a share of nearly 62% of the world tractor production, their share in global 3PL demand is only around 38%. North America, being one of the most mature tractor markets, contributes around 12% of the world tractor demand, and contributed almost 19% of the total demand for 3PL in the world in 2020. The global market for articulated joints was USD 520 million in 2020, with 80% and above of the demand from four key geographies China, Japan, Europe and North America. The demand for PMP products is expected to grow at a CAGR of 7% and 9% between 2020 and 2025, powered by strong volume growth in construction equipment production in key markets such as Japan and Europe. (Source: CRISIL Report) We believe we are well positioned to benefit from increasing mechanization in the agriculture and CFM sectors, in particular through leveraging our global business model, which allows us to efficiently serve OEMs across multiple global locations, contributing to their increasing efforts to rationalize their supply chain and asset/working capital management.

We offer fully integrated engineering solutions from conceptualization, development and validation to implementation and manufacturing of our products. The conceptualization stage involves acquiring market intelligence, assessing customer requirement and formulating customized strategy for individual customers. The development phase includes product designing, material procurement and processing. This is followed by the validation phase, which involves prototyping, testing and feasibility analysis. Our in-house manufacturing and implementation competencies include forging, machining, fabrications, heat treatment, surface finish, logistics, quality and testing, design and validation. By means of servicing our aftermarket segment customers, our products find indirect access to a large set up of retail stores across geographies for aftermarket components. Within the aftermarket category, we are focused on the ‘will-fit’ parts segment, sold to distributors and retail chain stores.

In Fiscal 2019, 2020 and 2021 and in the nine months ended December 31, 2021, revenue generated from the agriculture and CFM segments together constituted 95.59%, 95.74%, 96.07% and 95.42%, respectively, of our total revenue from operations. Our customer base comprises a number of the global OEMs and in our experience, our ability to serve such customers has allowed us to scale our operations over the years. We have long-term relationships with global OEM players in the agriculture and CFM sectors, such as Tractors and Farm Equipment Limited (“TAFE”), Doosan Bobcat North America (“Bobcat”), Claas Agricultural Machinery Private Limited (“Claas Tractors”), Yanmar Global Expert Co., Ltd (“Yanmar”) and LS Mtron Limited. We service several organized aftermarket players and large farm and fleet retail store chains in Europe and the US, such as Kramp Groep B.V. (“Kramp”) and Tractor Supply Company (“TSC”). As of December 31, 2021, our customer base comprised over 125 customers in over 25 countries globally. Bobcat, TAFE and Kramp are some of the customers with whom we have had relationships for over 15 years, while with customers like Yanmar, we have a relationship with for over 10 years. More recently, we have added TSC and Kobelco Construction Equipment India Private Limited (“Kobleco”) as our customers. Customers we acquired in 2017 onwards, accounted for 4.80%, 6.97%, 11.13% and 9.62%, respectively, of our revenue from operations in Fiscal 2019, 2020 and 2021 and the nine months ended December 31, 2021.

As of December 31, 2021, we have a global footprint and served customers across countries in North and South America, Europe, Asia and Australia, including India. We primarily serve OHV players including OEMs and aftermarket retail store chains, through our global business model based on our dual-shore integrated manufacturing, warehousing and supply chain management systems and solutions. Our global business model has contributed in the evolution of our relationships with our key customers, as we are able to serve multiple delivery locations and provide multiple delivery options with flexible lead times and costs, allowing us to better serve our customers with multiple price points based on different delivery models.

Our global business model is based on our sales in regions outside India (“International Sales”); sales from our dual shore manufacturing facilities in India and United States, in their respective domestic markets (“Local Deliveries”); export sales from Indian locations directly to overseas customers (“Direct Exports”); and sales

from our warehousing facilities in their respective domestic markets (“Warehouse Sales”). The table below sets forth details of our revenues based on our global business model:

Particulars	Fiscal 2019		Fiscal 2020		Fiscal 2021		Nine Months ended December 31, 2021	
	(₹ million)	Percentage of Revenue from Operations (%)	(₹ million)	Percentage of Revenue from Operations (%)	(₹ million)	Percentage of Revenue from Operations (%)	(₹ million)	Percentage of Revenue from Operations (%)
International Sales	8,830.04	83.26	7,580.04	83.55	7,255.35	80.33	7,175.29	81.45
Local Deliveries	3,624.06	34.19	2,945.63	32.47	2,547.04	28.20	2,210.78	25.10
Direct Exports	2,480.25	23.36	2,065.04	22.76	2,428.49	26.89	2,743.51	31.14
Warehouse Sales	4,065.13	38.33	3,715.42	40.95	3,713.11	41.11	3,491.67	39.64

In India, we have five manufacturing facilities, two at Ludhiana, Punjab, one at Visakhapatnam, Andhra Pradesh, and two at Noida, Uttar Pradesh. We have also set-up a distribution facility in Noida, Uttar Pradesh. In the United States, we have a manufacturing, warehousing and distribution facility at Eldridge, Iowa, acquired pursuant to our acquisition in 2005 of Olsen Engineering LLC, now known as Uniparts Olsen Inc. (“**UOI**”) and a warehousing and distribution facility at Augusta, Georgia. We have also set up a warehousing and distribution facility in Hennef, Germany, which serves as our base for serving our key European customers. Each of our facilities are strategically located in proximity to several global OEMs in the OHV industry.

We are promoted by first generation entrepreneurs, Gurdeep Soni, our Chairman and Managing Director, and Paramjit Singh Soni, our Executive Director and Vice Chairman, who have over three decades of experience in this business. Our Group Chief Operating Officer, Sudhakar S Kolli and our Non-Executive Director, Herbert Coenen have extensive experience in OHV space having worked with global corporations in the past. Under their leadership we have been able to expand our operations and have established a significant presence in India and globally. We also have a qualified and experienced senior management team that has demonstrated its ability to anticipate and capitalize on changing market trends, manage and grow our operations and leverage and deepen customer relationships. Our management team is strategically located in key end-markets with Paramjit Singh Soni in the United States, Gurdeep Soni and Sudhakar S Kolli in India and Herbert Coenen in Germany.

The following table sets forth certain information relating to certain key financial performance metrics in the periods indicated:

Particulars	As of and for the year ended March 31,			As of and for the nine months ended December 31, 2021
	2019	2020	2021	
Revenue from Operations	10,605.66	9,072.20	9,031.42	8,808.92
EBITDA <sup>(1)</sup>	1,398.48	1,278.10	1,639.26	2,013.48
EBITDA Margin <sup>(2)</sup> (%)	13.19	14.09	18.15	22.86
Restated profit for the year / period	695.97	626.42	923.86	1,223.36
Restated profit for the year / period Margin (%) <sup>(3)</sup>	6.56	6.90	10.23	13.89
Return on Average Equity (“RoAE”) (%) <sup>(4)</sup>	17.68	14.14	18.05	19.97*
Return on Capital Employed (“RoCE”) (%) <sup>(5)</sup>	15.37	13.98	19.81	23.14*
Net Debt / EBITDA Ratio	2.36	1.87	0.71	0.63*
Cash Flow from Operations / EBITDA	(0.04)	1.04	0.93	0.18

Notes:

1. EBITDA is calculated as restated profit for the year / period plus tax expense plus depreciation and amortization plus finance costs plus exceptional items.
2. EBITDA Margin is calculated as EBITDA divided by revenue from operations.
3. Restated profit for the year / period margin is calculated as restated profit for the year / period divided by revenue from operations.
4. RoAE is calculated as Net profit after tax divided by Average Equity.
5. RoCE is calculated as Earnings before interest and taxes (EBIT) divided by Capital Employed.

\* Non-annualised

## SIGNIFICANT FACTORS AFFECTING OUR RESULTS OF OPERATIONS AND FINANCIAL CONDITION

We believe that the following factors have significantly affected our results of operations and financial condition during the periods under review and may continue to affect our results of operations and financial condition in the future.

### *Market conditions affecting the OHV industry*

The sales of our products are directly related to the production and sales of OHVs by our major customers. OHV production and sales may be affected by general economic or industry conditions, including seasonal trends in the agriculture sector and cyclical or countercyclical effects in the CFM sector, recessionary trends in the global and domestic economies, volatility in new housing construction, as well as evolving regulatory requirements, government initiatives, trade agreements and other factors including volatile fuel prices, rising employee expenses and challenges in maintaining amicable labor relations. The cyclical nature of the agriculture and CFM industries, both globally and in regions in which we operate, means that our revenues across periods could fluctuate significantly.

It is difficult to forecast the potential for labor disputes or the success or sustainability of any strategies undertaken by any of our major customers in response to the current economic or industry environment. Unfavorable industry conditions can also result in an increase in commercial disputes and other risks of supply disruption. A sustained decline in the demand for products produced by our OEM customers could prompt them to cut their production volumes, directly affecting the demand from OEMs for our products and consequently adversely impacting our revenues.

### *Global business model*

We have set up our global business model in a scalable manner, optimized to provide premium-priced Local Deliveries manufactured onshore in smaller lots and with shorter lead times, as well as cost-competitive offshore deliveries from India with longer lead times and greater inventory cycles. As part of our growth strategy, we intend to focus on increasing our Warehouse Sales, on which we enjoy better margins. Towards implementation of this strategy, we are increasingly serving some of our largest customers in the OEM as well as aftermarket segments through the Warehouse Sales model. Accordingly, we expect that the proportion of our Warehouse Sales may increase going forward, as compared to Direct Exports and Local Deliveries, which we believe may have a favorable impact on our margins, going forward.

The table below sets forth details of our revenues based on our global business model:

Particulars	Fiscal 2019		Fiscal 2020		Fiscal 2021		Nine Months ended December 31, 2021	
	(₹ million)	Percentage of Revenue from Operations (%)	(₹ million)	Percentage of Revenue from Operations (%)	(₹ million)	Percentage of Revenue from Operations (%)	(₹ million)	Percentage of Revenue from Operations (%)
International Sales	8,830.04	83.26%	7,580.04	83.55%	7,255.36	80.33%	7,175.29	81.45%
Local Deliveries	3,624.05	34.19%	2,945.63	32.47%	2,547.04	28.20%	2,210.78	25.10%
Direct Exports	2,480.25	23.36%	2,065.04	22.76%	2,428.49	26.89%	2,743.51	31.14%
Warehouse Sales	4,065.13	38.33%	3,715.42	40.95%	3,713.11	41.11%	3,491.67	39.64%

However, an increased proportion of Warehousing Sales may lead to increased inventory maintained at our warehouses, leading to a higher overall working capital requirement. In addition, if a significant customer defaults in payment on any order to which we have devoted significant resources and built significant unsold inventory, it



may affect our profitability and liquidity and decrease capital resources available to us for other uses. For more information, see “*Our Business – Global Business Model*” on page 164.

### ***Customer concentration, purchasing patterns, terms of supply arrangements and pricing of our products***

A substantial majority of our income from operations is from sales to OEMs. These constituted 82.21%, 82.12%, 77.31% and 77.31%, respectively, of our revenue from operations during Fiscal 2019, 2020 and 2021 and in the nine months ended December 31, 2021, within which we depend on a limited number of customers for a significant portion of our revenues. Revenue from our top 10 customers across product segments was ₹ 8,022.13 million, ₹ 6,769.73 million, ₹ 6,600.07 million and ₹ 6,230.21 million and constituted 75.64%, 74.62%, 73.08% and 70.73%, respectively, of our revenue from operations during Fiscal 2019, 2020 and 2021 and in the nine months ended December 31, 2021. The demand for our products from such major customers has a significant impact on our results of operations and financial condition, and our sales are particularly affected by the inventory and production levels of our key OEM customers. The volume and timing of sales to our customers may vary due to variation in demand for our customers’ products, our customers’ attempts to manage their inventory, design changes, changes in their product mix, manufacturing strategy and growth strategy, and macroeconomic factors affecting the economy in general and our customers in particular. We may experience reduction in cash flows and liquidity if we lose one or more of our major customers, or if the amount of business from them is reduced for any reason, or if we are unable to forecast the level of customer demand for our products accurately, schedule our raw material purchases and production and manage our inventory.

Basis the business arrangements and established practices, certain of our customers provide us with forecasts of business volumes, which enable us to predict our income for a portion of our business; however, the actual orders are placed by way of on-going purchase orders. Therefore, actual production volumes may vary significantly from these forecasts. There may be instances where customers modify their product specifications and/or timing of procurement with little advance notice, which may require us to increase or decrease production and inventories at short notice and bear additional costs. Further, timing mismatches between our customer orders and our supplier deliveries may impact availability of raw materials required by us, or may lead us to incur additional costs.

Our supply arrangements and established practices with our key OEM customers typically provide for periodic price review of our products. In addition, under some of our supply arrangements with our key OEM customers, we may be required to provide an annual cost reduction in relation to our products. Our continued ability to undertake value engineering and provide cost reductions to our customers is linked to our ability to maintain or improve our margins. Any significant cost reductions that we are not able to compensate for through value engineering and process innovation may, therefore, reduce our profitability.

The general terms of supply with key OEM customers may also contain certain standards and performance obligations and our failure to meet such specification could result in reduction of business, termination of contracts or additional costs and penalties.

### ***Input and employee costs***

Our cost of raw material and components consumed, including change in inventory, represented 35.11%, 36.24%, 39.07% and 31.12%, respectively, of our revenue from operations during Fiscal 2019, 2020 and 2021 and in the nine months ended December 31, 2021. Our results of operations are significantly impacted by the availability and cost of raw materials, in particular steel. Steel accounted for 62.29%, 63.80%, 59.18% and 59.96% of our total raw material purchases in Fiscal 2019, 2020 and 2021 and in the nine months ended December 31, 2021, respectively. The steel sourced in India accounted for 45.78%, 45.88%, 51.44% and 53.21% and our expenditure on steel sourced in U.S accounted for 16.51%, 17.92%, 7.74% and 6.75% of our raw material purchases in Fiscal 2019, 2020 and 2021 and in the nine months ended December 31, 2021, respectively. For our Indian manufacturing operations, we source steel directly from Indian steel mills. We have also developed a supply chain for sourcing specific forms of steel, such as seamless tubes and steel bars, from China, for our manufacturing facilities in India. Steel used for products manufactured in our facility at Eldridge, Iowa, is primarily sourced in the U.S. from distributors.

While we are not significantly dependent on any single raw material supplier, raw material supply and pricing can be volatile due to a number of factors beyond our control. Commodity prices are influenced by, among other factors, changes in global economic conditions, industry cycles, demand-supply dynamics, attempts by producers to capture market share and speculation in the market, as well as import duties, tariffs and currency exchange rates. The changes in raw material costs are generally passed through to our customers. Nonetheless, because such

price adjustments based on cost changes only occur at periodic intervals, there is generally a time lag between changes in our raw material costs and any adjustments to prices of our products, which, if such raw material costs increase significantly during this period, can have a negative impact on our profitability. We also seek to increase our margins by improving our procurement costs for steel in India and obtaining better credit terms from our suppliers and better financing terms under our working capital facilities.

Employee benefits expense comprises our second largest expense after raw material costs. In Fiscal 2019, 2020 and 2021 and in the nine months ended December 31, 2021, our employee benefits expense were ₹ 2,217.42 million, ₹ 2,117.62 million, ₹ 1,854.48 million and ₹ 1,605.86 million, respectively, and accounted for 20.91%, 23.34%, 20.53% and 18.23%, respectively, of our revenue from operations in such periods. The decline in employee benefit expenses in recent periods is primarily on account of reduction in headcount. We are both backward and forward integrated in terms of our operations which as a business model inherently has higher manpower cost but at the same time helps in managing material cost, product quality and customer service levels. However, we believe that we have sufficient human resources to sustain our current operations and planned growth, particularly at the management level. Our employee benefit expenses are affected by statutorily prescribed minimum wage as well as wage payments following retrenchment, besides the increase in headcount due to increase in volumes. As a material portion of our overall manpower is located in India, any increase in wages in India will have a material impact on our net income. Recently, the Government of India enacted the Code on Wages, 2019, the Occupational Safety, Health and Working Conditions Code, 2020 and the Industrial Relations Code, 2020, all of which will be brought into force on a date to be notified by the Central Government. For details, see “*Key Regulations and Policies in India*” on page 176. These codes propose to subsume several existing laws and regulations in India and could impose more stringent or additional compliance requirements on us, which may increase our compliance costs and adversely affect our profitability. While our employee benefit expenses may increase in absolute terms, we expect to improve our operational efficiencies, which we believe may result in a reduction in our employee benefits expense as a percentage of our revenue from operations.

#### ***Macroeconomic conditions***

Our sales volumes, profitability and liquidity are closely tied to the level of agricultural and CFM activity worldwide, as our customers and end-users primarily operate in the agriculture and CFM sectors and are, therefore, affected by factors that affect the agriculture and CFM sectors, including the levels of investment and production in these specific sectors of the global and domestic economies. In particular, the agricultural sector is inherently seasonal and is further impacted by factors including agricultural commodity prices, costs of fertilizers and adverse weather conditions. There may also be a number of secondary effects of an economic downturn, such as the insolvency of suppliers or customers, delays in deliveries by suppliers, payment delays and/or stagnant demand by customers. Cuts in federal or central, state and local government investment as well as consequent impairment in infrastructural facilities and growth can also drag down global and national growth rates.

Further, our business plans envisage enhancing our operations in line with our customers’ growth in key markets, including India, Europe and Japan. We expect to continue to incur expenditure in connection with setting up new capacity, which would require us to successfully attract additional business from our existing and new customers. While we take into account market and customer requirements and opportunities prior to expanding in current markets or setting up operations in new markets, our customers may not give us sufficient commitments to purchase our products in these markets. Accordingly, our successful expansion in any market is subject to business, economic and competitive uncertainties and contingencies, many of which are beyond our control.

#### ***Foreign currency fluctuations***

We are exposed to foreign exchange rate fluctuations in respect of (i) our foreign currency denominated borrowings (mainly in US Dollar), (ii) currency mismatches between our revenues and expenses, and (iii) currency translation losses for the purpose of preparing our consolidated financial statements (which are presented in Indian Rupees), on account of our global operations.

Our revenues, operating expenses and finance costs are influenced by the currencies of those countries where we manufacture and/or sell our products (for example, the United States, Europe and Japan). The exchange rate between the Indian Rupee and these currencies, primarily the US Dollar, has fluctuated in the past and our results of operations have been impacted by such fluctuations in the past and may be impacted by such fluctuations in the future. For example, during times of strengthening of the Indian Rupee, we expect that our overseas sales and revenues will generally be negatively impacted as foreign currency received will be translated into fewer Indian Rupees. However, the converse positive effect of depreciation in the Indian Rupee may not be sustained or may

not show an appreciable impact in our results of operations in any given financial period, due to other variables impacting our business and results of operations during the same period. Moreover, as a majority of our long-term (non-current) and working capital borrowings are US Dollar and Euro denominated, we expect that our cost of borrowing as well as our cost of raw materials and components incurred by our foreign Subsidiaries may rise during a sustained depreciation of the Indian Rupee against the US Dollar or the Euro.

We may, therefore, suffer losses on account of foreign currency fluctuations for our inventory in our international warehouses, since the prices that our customers pay for our products are only subject to revision for foreign currency fluctuations on a periodic basis and in certain cases outside a specified range and we may not be able to pass on all losses on account of foreign currency fluctuations to our customers. Moreover, we may be required to reconfigure our loan portfolio from time to time, so as to effectively manage our finance charges.

While we seek to hedge our foreign currency risk by entering into forward exchange contracts or matching our revenue and expenses currency as much as possible, any action that we may take or any amounts we spend or invest in order to hedge the risks on account of fluctuations in currencies may not adequately hedge against any losses we incur due to such fluctuations. Our exchange differences (net) for Fiscal 2019, 2020 and 2021 and for the nine months ended December 31, 2021 amounted to loss of ₹ 29.01 million, gain of ₹ 32.71 million, gain of ₹ 66.38 million and gain of ₹ 110.15 million, respectively. As on December 31, 2021, our total unhedged foreign currency receivables amounted to ₹ 46.18 million, our total unhedged foreign currency loans amounted to ₹ 5.09 million, while our total unhedged foreign currency payables amounted to ₹ 1.64 million and the total value of our outstanding forward exchange contracts amounted to ₹ 2,096.82 million.

## **PRESENTATION OF FINANCIAL INFORMATION**

Our Restated Financial Statements have been compiled from:

- The audited special purpose interim consolidated financial statements as at and for the nine months ended December 31, 2021 prepared in accordance with Ind AS 34 'Interim Financial Reporting', specified under section 133 of the Companies Act, 2013 and other accounting principles generally accepted in India; and
- The audited consolidated financial statements as at and for the years ended March 31, 2021, March 31, 2020 and March 31, 2019 prepared in accordance with the Ind AS as prescribed under section 133 of the Companies Act, 2013 read with the Companies (Indian Accounting Standards) Rules 2015, as amended, and other accounting principles generally accepted in India.

## **NON-GAAP MEASURES**

### ***Earnings before Interest, Taxes, Depreciation and Amortization Expenses ("EBITDA")/ EBITDA Margin***

EBITDA presented in this Draft Red Herring Prospectus is a supplemental measure of our performance and liquidity that is not required by, or presented in accordance with, Ind AS, Indian GAAP, IFRS or US GAAP. Further, EBITDA is not a measurement of our financial performance or liquidity under Ind AS, Indian GAAP, IFRS or US GAAP and should not be considered in isolation or construed as an alternative to cash flows, profit/(loss) for the years/ period or any other measure of financial performance or as an indicator of our operating performance, liquidity, profitability or cash flows generated by operating, investing or financing activities derived in accordance with Ind AS, Indian GAAP, IFRS or US GAAP. In addition, EBITDA is not a standardised term, hence a direct comparison of EBITDA between companies may not be possible. Other companies may calculate EBITDA differently from us, limiting its usefulness as a comparative measure. Although EBITDA is not a measure of performance calculated in accordance with applicable accounting standards, our Company's management believes that it is useful to an investor in evaluating us because it is a widely used measure to evaluate a company's operating performance.

### ***Reconciliation of EBITDA and EBITDA Margin to profit before share of gain/ (loss) in Profit after Tax***

The table below reconciles restated (loss) / profit for the year to EBITDA. EBITDA is calculated as profit/loss for the year/ period, plus finance costs, depreciation and amortization expenses, less other income, while EBITDA Margin is the percentage of EBITDA divided by revenue from operations.

Particulars	2019	Fiscal 2020	2021	Nine months ended December 31, 2021
	(₹ million)			
<b>Restated Profit before exceptional items and tax</b>	<b>915.54</b>	<b>744.03</b>	<b>1,185.60</b>	<b>1,699.54</b>
<b>Adjustments:</b>				
Add: Finance Costs	181.98	179.65	81.07	42.28
Add: Depreciation and Amortization expense	300.96	354.42	372.59	271.66
<b>Earnings before interest, taxes, depreciation and amortization expenses (EBITDA) (A)</b>	<b>1,398.48</b>	<b>1,278.10</b>	<b>1,639.26</b>	<b>2,013.48</b>
<b>Revenue from Operations (B)</b>	<b>10,605.66</b>	<b>9,072.20</b>	<b>9,031.42</b>	<b>8,808.92</b>
<b>EBITDA Margin (EBITDA as a percentage of revenue from operations) (A/B)</b>	<b>13.19%</b>	<b>14.09%</b>	<b>18.15%</b>	<b>22.86%</b>

## SIGNIFICANT ACCOUNTING POLICIES

### *Business Combinations and Goodwill*

At the acquisition date, the identifiable assets acquired and the liabilities assumed are recognised at their acquisition date fair values. For this purpose, the liabilities assumed include contingent liabilities representing present obligation and they are measured at their acquisition fair values irrespective of the fact that outflow of resources embodying economic benefits is not probable. However, the following assets and liabilities acquired in a business combination are measured at the basis indicated below:

Deferred tax assets or liabilities, and the assets or liabilities related to employee benefit arrangements are recognised and measured in accordance with Ind AS 12 Income Tax and Ind AS 19 Employee Benefits respectively.

When the Group acquires a business, it assesses the financial assets and liabilities assumed for appropriate classification and designation in accordance with the contractual terms, economic circumstances and pertinent conditions as at the acquisition date. This includes the separation of embedded derivatives in host contracts by the acquire.

Contingent consideration classified as an asset or liability that is a financial instrument and within the scope of Ind AS 109 Financial Instruments, is measured at fair value with changes in fair value recognised in the statement of profit and loss. If the contingent consideration is not within the scope of Ind AS 109, it is measured in accordance with the appropriate Ind AS. Contingent consideration that is classified as equity is not remeasured at subsequent reporting dates and subsequent its settlement is accounted for within equity.

Goodwill is initially measured at cost, being the excess of the aggregate of the consideration transferred and the amount recognised for non-controlling interests, and any previous interest held, over the net identifiable assets acquired and liabilities assumed. If the fair value of the net assets acquired is in excess of the aggregate consideration transferred, the Group reassesses whether it has correctly identified all of the assets acquired and all of the liabilities assumed and reviews the procedures used to measure the amounts to be recognised at the acquisition date. If the reassessment still results in an excess of the fair value of net assets acquired over the aggregate consideration transferred, then the gain is recognised in Other Comprehensive Income (OCI) and accumulated in equity as capital reserve. However, if there is no clear evidence of bargain purchase, the Company recognises the gain directly in equity as capital reserve, without routing the same through OCI.

After initial recognition, goodwill is measured at cost less any accumulated impairment losses. For the purpose of impairment testing, goodwill acquired in a business combination is, from the acquisition date, allocated to each of the Group's cash-generating units that are expected to benefit from the combination, irrespective of whether other assets or liabilities of the acquirer are assigned to those units.

### *Current versus non-current classification*

The assets and liabilities are presented as current or non-current in the balance sheet by the Group.

An asset is treated as current when it is expected that it will be realised or intended to be sold or consumed in

normal operating cycle, it is held primarily for trading purposes, it is expected to be realised within twelve months after the reporting period or cash or cash equivalents unless restricted from being exchanged or used to settle a liability for at least twelve months after the reporting period.

All other assets are treated as non-current in the balance sheet.

A liability is treated as current when it is expected to be settled in normal operating cycle, if it is held primarily for the purpose of trading, it is due to be settled within twelve months after the end of the reporting period or there is no unconditional right to defer the settlement of the liability for at least twelve months after the reporting period.

The Group classifies all other liabilities as non-current in the balance sheet.

The Group identifies its operating cycle as twelve months.

Deferred tax asset and liabilities are classified as non-current assets or liabilities in the balance sheet.

### ***Critical Accounting Judgments and Key Sources of Estimation Uncertainties***

The following are the critical judgments and the key estimates concerning the future that management has made in the process of applying the Group's accounting policies and these may have the most significant effect on the amounts recognized in the Restated financial information or have a significant risk of causing a material adjustment to the carrying amounts of assets and liabilities within the next financial year. The estimates and associated assumptions are based on historical experiences and other factors that are considered to be relevant. The estimates and underlying assumptions are reviewed on an on-going basis. Revision of accounting estimates are recognised in the period in which the estimates are revised if the revision affects only that period or in the period of the revision and future periods where revision affects both current and future periods.

#### *Intangible Assets*

Capitalization of cost for intangible assets and intangible assets under development is based on the management judgment that technological and economic feasibility is confirmed and assets under development will generate economic benefits in future. Based on the evaluation carried out, the Group's management has determined that there are no factors which indicate that those assets have suffered any impairment loss.

#### *Useful Life of Depreciable Assets*

Management reviews the useful life of depreciable assets at each reporting date. As at 31st December 2021 management assessed that the useful life represents the expected utility of the assets by the Group. Further there is no significant change in useful life as compared to the previous year.

#### *Impairment of Non-Financial Assets*

The Group assesses at each reporting date whether there is an indication that an asset may be impaired. If any indication exists, or when annual impairment testing for an asset is required, the Group estimates the asset's recoverable amount. An asset's recoverable amount is the higher of an asset's or Cash Generating Unit's (CGU) fair value less costs of disposal and its value in use. It is determined for an individual asset, unless the asset or CGU exceeds its recoverable amount, the asset is considered impaired and is written down to its recoverable amount.

In assessing the value in use, the estimated future cash flows are discounted to their present value using a pre-tax discount rate that reflects current market assessments of the time value of money and risks specific to the asset. In determining the fair value less costs to disposal, recent market transactions are taken into account. If no such transactions can be identified, an appropriate valuation model is used.

Intangible assets under development are tested for impairment annually. Impairment losses including impairment on inventories are recognised in the consolidated statement of profit and loss.

#### *Impairment of Financial Assets*

The impairment provisions for financial assets are based on assumptions about risk of default and expected loss rates. The Group uses judgment in making these assumptions and selecting the inputs to the impairment

calculation, based on Group's past history, existing market conditions as well as forward looking estimates at the end of each reporting period.

#### *Defined Benefit Plans*

The cost of the defined benefit gratuity plan, other post-employment plans and the present value of the gratuity obligation is determined using actuarial valuations. An actuarial valuation involves making various assumptions that may differ from actual developments in the future. These include the determination of the discount rate, future salary increases and mortality rates. Due to the complexities involved in the valuation and its long-term nature, a defined benefit obligation is highly sensitive to changes in these assumptions. All assumptions are reviewed at each reporting date.

The mortality rate is based on publicly available mortality tables for India. Those mortality tables tend to change only at interval in response to demographic changes.

#### *Fair Value Measurement of Financial Instruments*

When the fair values of financial assets and financial liabilities recorded in the balance sheet cannot be measured based on quoted prices in active markets, their fair value is measured using suitable valuation techniques. The inputs to these models are taken from observable markets where possible, but where this is not feasible, a degree of judgment is required in establishing fair values. Judgments include considerations of inputs such as liquidity risk, credit risk and volatility. Changes in assumptions about these factors could affect the reported fair value of financial instruments.

#### *Income Tax and Deferred Tax*

Significant management judgment is required to determine the amount of deferred tax assets that can be recognised, based upon the likely timing and the level of future taxable profits together with future tax planning strategies.

#### ***Financial Instruments***

A financial instrument is any contract that gives rise to a financial asset of one entity and a financial liability or equity instrument of another entity.

#### *Initial Recognition and Measurement*

On initial recognition, all the financial assets are recognized at their fair value plus or minus, in the case of a financial asset or financial liability not at fair value through profit or loss (FVTPL), transaction costs that are directly attributable to the acquisition or issue of the financial asset or financial liability.

All financial liabilities are recognised initially at fair value and, in the case of loans, borrowings and payables, net of directly attributable transaction costs.

The Group's financial liabilities include trade and other payables, loans and borrowings including bank overdrafts and derivative financial instruments.

#### *Subsequent Measurement*

#### *Financial Assets Carried at Amortised Cost*

A financial asset is subsequently measured at amortised cost if it is held within a business model whose objective is to hold the asset in order to collect contractual cash flows and the contractual terms of the financial asset give rise on specified dates to cash flows that are solely payments of principal and interest on the principal amount outstanding.

The trade and other receivables, after initial measurement are subsequently measured at amortised cost using the effective interest rate (EIR) method. Amortised cost is calculated by taking into account any discount or premium on acquisition and fees or costs that are an integral part of the EIR. The EIR amortisation is included in other income in the statement of profit and loss. The losses arising from impairment are recognised in the statement of profit and loss.

### Financial Assets at Fair Value Through Other Comprehensive Income (FVTOCI)

A financial asset is subsequently measured at fair value through other comprehensive income if it is held within a business model whose objective is achieved by both collecting contractual cash flows and selling financial assets, and the contractual terms of the financial asset give rise on specified dates to cash flows that are solely payments of principal and interest on the principal amount outstanding.

Financial assets included within the FVTOCI are measured initially as well as at each reporting date at fair value. Fair value movements are recognized in the other comprehensive income (OCI). However, the Group recognizes interest income, impairment losses, reversals and foreign exchange gain or loss in the statement of profit and loss. On derecognition of the asset, cumulative gain or loss previously recognised in OCI is reclassified from the equity to statement of profit and loss. Interest earned whilst holding FVTOCI debt instrument is reported as interest income using the EIR method.

### Financial assets at fair value through profit or loss (FVTPL)

A financial asset which is not classified in any of the above categories is subsequently measured at fair value through profit or loss.

### Financial Liabilities

The financial liabilities are subsequently carried at amortized cost using the effective interest method. For trade and other payables maturing within one year from the balance sheet date, the carrying amounts approximate fair value due to the short-term maturity of these instruments. This category also includes derivative financial instruments entered into by the Group that are not designated as hedging instruments in hedge relationships as defined by Ind AS 109.

Loans and borrowings is the category most relevant to the Group. After initial recognition, interest-bearing loans and borrowings are subsequently measured at amortised cost using the EIR method. Gains and losses are recognised in statement of profit and loss when the liabilities are derecognised as well as through the EIR amortisation process. In the calculation of amortised cost, discount or premium on acquisition and fees or costs that are an integral part of the EIR are taken into account. This category generally applies to borrowings.

### Fair value measurement of financial instruments

The fair value of financial instruments is determined using the valuation techniques that are appropriate in the circumstances and for which sufficient data are available to measure fair value, maximising the use of relevant observable inputs and minimising the use of unobservable inputs.

Based on the three level fair value hierarchy, the methods used to determine the fair value of financial assets and liabilities include quoted market price, discounted cash flow analysis and valuation certified by the external valuer.

In case of financial instruments where the carrying amount approximates fair value due to the short maturity of those instruments, carrying amount is considered as fair value.

### Derecognition of Financial Instrument

A financial asset is derecognized when the contractual rights to the cash flows from the financial asset expire or has transferred the financial asset and the transfer qualifies for derecognition under Ind AS 109.

When the Group has transferred its rights to receive cash flows from an asset or has entered into a pass through arrangement, it evaluates if and to what extent it has retained the risks and rewards of ownership. When it has neither transferred nor retained substantially all of the risks and rewards of the asset, nor transferred control of the asset, the Group continues to recognise the transferred asset to the extent of the Group's continuing involvement. In that case, the Group also recognises an associated liability. The transferred asset and the associated liability are measured on a basis that reflects the rights and obligations that the Group has retained.

A financial liability is derecognized when the obligation specified in the contract is discharged or cancelled or expired. When an existing financial liability is replaced by another from the same lender on substantially different terms, or the terms of an existing liability are substantially modified, such an exchange or modification is treated as the derecognition of the original liability and the recognition of a new liability. The difference in the respective

carrying amounts is recognised in the statement of profit and loss.

### ***Inventories***

Inventories are valued as below:

- Raw materials, packing materials and consumable stores and spares are valued at cost computed on FIFO method.
- Work-in-progress are valued at materials cost plus appropriate share of labour and production overheads incurred till the stage of completion of production.
- Finished goods are valued at lower of the cost or net realizable value.
- Scrap is valued at net realizable value calculated based on last month's average realization.

### ***Revenue Recognition***

Revenue is recognised to the extent it is probable that the economic benefits will flow to the Group and the revenue can be reliably measured, regardless of when the payment is being made. Revenue is measured at the fair value of the consideration received or receivable, taking into account contractually defined terms of payment and excluding taxes or duties collected on behalf of the government.

Revenue is presented net of goods and service tax (GST), wherever applicable. However, GST is not received by the Group on its own account. Rather, it is tax collected on value added to the commodity by the Group on behalf of the Government. Accordingly, these are excluded from revenue.

The specific recognition criteria as described below must also be met before revenue is recognised.

#### *Sale of Goods*

Revenue is recognised when the customer obtains control of the goods. The customer obtains control of goods at the different point in time based on the delivery terms. Accordingly, Group satisfies its performance obligation at the time of dispatch of goods from the factory/stockyard/storage area/port as the case may be and accordingly revenue is recognised. Revenue from the sale of goods is measured at the fair value of the consideration received or receivable, net of returns and allowances, trade discounts and volume rebates.

The determination of transaction price, its allocation to promised goods and allocation of discount or variable compensation (if any) is done based on the contract with the customers.

The incremental costs that the Group incurs to obtain a contract with a customer that it would not have incurred if the contract had not been obtained are recognised as an asset if its recovery is expected and its amortisation period is more than one year, all other such costs are recognised as an expense in the statement of profit and loss. The incremental cost recognised as an asset is amortised over the period till when such cost is expected to be recovered. Amount so recovered is recognised as revenue in the consolidated statement of profit and loss.

#### *Export Incentives*

Revenue from export incentives are accounted for on export of goods if the entitlements can be estimated with reasonable assurance and conditions precedent to claim are fulfilled.

#### *Die Design and Preparation Charges*

Revenues from die design and preparation charges are recognized as per the terms of the contract as and when the significant risks and rewards of ownership of dies are transferred to the buyers.

#### *Interest Income*

For all debt instruments measured either at amortised cost or at fair value through other comprehensive income, interest income is recorded using the effective interest rate (EIR). EIR is the rate that exactly discounts the estimated future cash receipts over the expected life of the financial instrument or a shorter period, where



appropriate, to the gross carrying amount of the financial asset or to the amortised cost of a financial liability. When calculating the effective interest rate, the Group estimates the expected cash flows by considering all the contractual terms of the financial instrument (for example, prepayment, extension, call and similar options) but does not consider the expected credit losses. Interest income is included in other income in the statement of profit and loss.

#### *Dividends*

Dividend income is recognised when the Group's right to receive the payment is established, which is generally when shareholders approve the dividend.

#### *Insurance and Other Claims*

Insurance and other claims are recognised as revenue only when it is reasonably certain that the ultimate collection will be made.

#### *Government Grants*

Government grants are recognised where there is reasonable assurance that the grant will be received and all attached conditions will be complied with. When the grant or subsidy relates to revenue, it is recognized as income on a systematic basis in the consolidated statement of profit and loss over the periods necessary to match them with the related costs, which they are intended to compensate.

Where the grant relates to an asset, it is recognized as deferred income and is allocated to consolidated statement of profit and loss over the periods and in the proportions in which depreciation on those assets is charged.

#### *Property, Plant and Equipment*

##### *Tangible Assets*

Depreciation on tangible assets is provided on the straight-line method at the rates and manner prescribed under Schedule II of the Companies Act, 2013 except in the case of plant and machinery where the depreciation has been provided on the basis of the useful lives of the assets estimated by the management based on internal assessment and independent technical evaluation carried out by external chartered engineer at the time of adoption of Companies Act, 2013. Depreciation for the assets purchased / sold during the year is proportionately charged.

The estimated useful lives are as mentioned below:

Type of Asset	Method	Useful Lives
Leasehold land	Straight Line	Over the period of lease or estimated useful life, whichever is lower.
Factory Building	Straight Line	30 years
Furniture and Fittings	Straight Line	10 Years
Plant and Machinery	Straight Line	10 - 20 Years
Office Equipment	Straight Line	5 Years
Computers	Straight Line	3 - 6 Years
Vehicles	Straight Line	8 - 10 Years

An item of property, plant and equipment and any significant part initially recognised is derecognised upon disposal or when no future economic benefits are expected from its use or disposal. Any gain or loss arising on derecognition of the asset (calculated as the difference between the net disposal proceeds and the carrying amount of the asset) is included in the income statement when the asset is derecognised.

The residual values, useful lives and methods of depreciation of property, plant and equipment are reviewed at each financial year end and adjusted prospectively, if appropriate.

Property, plant and equipment are stated at cost of acquisition or construction net of accumulated depreciation and impairment loss (if any). Internally manufactured property, plant and equipment are capitalized at cost, including non-convertible excise duty, wherever applicable, GST wherever applicable. All significant costs relating to the acquisition and installation of property, plant and equipment are capitalised. Such cost includes the cost of replacing part of the property, plant and equipment and borrowing costs for long-term construction projects

if the recognition criteria are met. When significant parts of plant and equipment are required to be replaced at intervals, the Group depreciates them separately based on their specific useful lives. Likewise, when a major inspection is performed, its cost is recognised in the carrying amount of the plant and equipment as a replacement if the recognition criteria are satisfied. All other repair and maintenance costs are recognised in statement of profit and loss as incurred. The present value of the expected cost for the decommissioning of an asset after its use is included in the cost of the respective asset if the recognition criteria for a provision are met.

Subsequent costs are included in the asset's carrying amount or recognised as a separate asset, as appropriate, only when it is probable that future economic benefits associated with the item will flow to the Group and the cost of the item can be measured reliably. The carrying amount of the replaced part is derecognised."

### ***Intangible Assets***

#### *Recognition and Initial Measurement*

Purchased Intangible assets are stated at cost less accumulated amortisation and impairment, if any.

#### *Internally Developed Intangible Assets*

Expenditure on the research phase of projects is recognised as an expense as incurred.

Costs that are directly attributable to a project's development phase are recognised as intangible assets, provided the Company can demonstrate the following:

- the technical feasibility of completing the intangible asset so that it will be available for use;
- its intention to complete the intangible asset and use or sell it;
- its ability to use or sell the intangible asset;
- how the intangible asset will generate probable future economic benefits;
- the availability of adequate technical, financial and other resources to complete the development and to use or sell the intangible asset;
- its ability to measure reliably the expenditure attributable to the intangible asset during its development costs not meeting these criteria for capitalisation are expensed as incurred; and
- Directly attributable costs include employee costs incurred on development of prototypes along with an appropriate portion of relevant overheads and borrowing costs.

#### *Goodwill*

Goodwill is initially measured at cost, being the excess of the aggregate of the consideration transferred and the amount recognised for non-controlling interests, and any previous interest held, over the net identifiable assets acquired and liabilities assumed. If the fair value of the net assets acquired is in excess of the aggregate consideration transferred, the Group re-assesses whether it has correctly identified all of the assets acquired and all of the liabilities assumed and reviews the procedures used to measure the amounts to be recognised at the acquisition date. If the reassessment still results in an excess of the fair value of net assets acquired over the aggregate consideration transferred, then the gain is recognised in OCI and accumulated in equity as capital reserve. However, If there is no clear evidence of bargain purchase, the entity recognises the gain directly in equity as capital reserve, without routing the same through OCI.

After initial recognition, goodwill is measured at cost less any accumulated impairment losses. For the purpose of impairment testing, goodwill acquired in a business combination is, from the acquisition date, allocated to each of the Group's cash-generating units that are expected to benefit from the combination, irrespective of whether other assets or liabilities of the acquire are assigned to those units.

#### *Foreign Currency Transactions*

### Functional and Presentation Currency

The financial statements are presented in Indian Rupee and are rounded to two decimal places of Million, which is also the functional and presentation currency of the Group.

### Transactions and Balances

Foreign currency transactions are recorded in the functional currency, by applying to the exchange rate between the functional currency and the foreign currency at the date of the transaction.

Foreign currency monetary items are converted to functional currency using the closing rate. Non-monetary items denominated in a foreign currency which are carried at historical cost are reported using the exchange rate at the date of the transactions.

Exchange differences arising on monetary items on settlement, or restatement as at reporting date, at rates different from those at which they were initially recorded, are recognized in the statement of profit and loss in the year in which they arise.

### **Employee Benefits**

#### *Short Term Employee Benefits*

All employee benefits that are expected to be settled wholly within twelve months after the end of the period in which the employees render the related service, are classified as short term employee benefits, which include salaries, wages, short term compensated absences and performance incentives and are measured at the amounts expected to be paid when the liabilities are settled. The liabilities are presented as current employee benefit obligations in the balance sheet. These are recognised as expenses in the period in which the employee renders the related service.

#### *Post-Employment Benefits*

Contributions towards superannuation fund, pension fund and government administered provident fund are treated as defined contribution schemes. In respect of contributions made to government administered provident fund, the Group has no further obligations beyond its monthly contributions. Such contributions are recognised as expense in the period in which the employee renders related service.

The cost of defined benefit such as is determined using the projected unit credit method, with actuarial valuation being carried out at each balance sheet date. Actuarial gains and losses in respect of the same are charged to the OCI.

#### *Other Long-Term Benefits*

All employee benefits other than post-employment benefits and termination benefits, which do not fall due wholly within twelve months after the end of the period in which the employees render the related service, including long term compensated absences, service awards, and ex-gratia are determined based on actuarial valuation carried out at each balance sheet date. Estimated liability on account of long term employee benefits is discounted to the present value using the yield on government bonds as the discounting rate for the term of obligations as on the date of the balance sheet. Actuarial gains and losses in respect of the same are charged to the statement of profit and loss.

#### *Termination Benefits*

Termination benefits are payable when employment is terminated by the Group before the normal retirement date, or when an employee accepts voluntary retirement in exchange of these benefits. The Group recognises termination benefits at the earlier of the following dates:

- when the Group can no longer withdraw the offer of those benefits; and

- when the entity recognises costs for a restructuring that is within the scope of Ind AS 37 and involves the payment of termination benefits. The termination benefits are measured based on the number of employees expected to accept the offer in case of voluntary retirement scheme.

## *Leases*

### *Determining Whether an Arrangement Contains a Lease*

At inception of a contract, the Group determines whether the contract is, or contains, a lease. The contract is, or contains, a lease if the contract conveys the right to control the use of an identified asset or assets for a period of time in exchange for consideration, even if that right is not explicitly specified in a contract.

At inception or on reassessment of a contract that contains lease component and one or more additional lease or non-lease components, the Group separates payments and other consideration required by the contract into those for each lease component on the basis of their relative Consolidated price and those for non-lease components on the basis of their relative aggregate stand-alone price. If the Group concludes that it is impracticable to separate the payments reliably, then right-of use asset and Lease liability are recognised at an amount equal to the present value of future lease payments; subsequently the liability is reduced as payments are made and an imputed finance cost on the liability is recognised using the Group's incremental borrowing rate.

### *Group as a Lessee*

At inception, the Group assesses whether a contract is or contains a lease. This assessment involves the exercise of judgement about whether it depends on an identified asset, whether the Group obtains substantially all the economic benefits from the use of that asset, and whether the Group has the right to direct the use of that asset.

The Group has elected to separate lease and non-lease components of contracts, wherever possible. The Group recognizes a right-of-use asset and a lease liability at the transition date/ lease commencement date. The right-of-use asset is initially measured based on the present value of future lease payments, plus initial direct costs wherever identifiable, and cost to dismantle and remove the underlying asset or to restore the underlying asset or the site on which it is located, and lease payments made at or before the commencement date, less any incentives received. The right-of-use asset is depreciated over the shorter of the lease term or the useful life of the underlying asset. The right-of-use asset is subject to testing for impairment if there is an indicator for impairment.

At the commencement date, Group measures the lease liability at the present value of the future lease payments that are not yet paid at that date discounted using interest rate implicit in the lease or, if that rate cannot be readily determined, the Group's incremental borrowing rate. Generally, the Group's uses its incremental borrowing rate as the discount rate. The lease liability is measured at amortised cost using the effective interest method. Lease liabilities are remeasured with a corresponding adjustment to the related right of use asset, if the Company changes its assessment whether it will exercise an extension or a termination option.

Contingent rents payments are recognised as an expense in the period in which they are incurred. Lease payments generally include fixed payments and variable payments that depend on an index (such as an inflation index). When the lease contains an extension or purchase option that the Group considers reasonably certain to be exercised, the cost of the option is included in the lease payments.

The Group has elected not to recognize right-of use assets and liabilities for leases where the total lease term is less than or equal to 12 months, or for leases of low value assets. The payments for such leases are recognized in the consolidated statement of profit and loss on a straight-line basis over the lease term.

### *Group as a Lessor*

Leases for which the Group is a lessor is classified as a finance or operating lease. Whenever the terms of the lease transfer substantially all the risks and rewards of ownership to the lessee, the contract is classified as a finance lease. All other leases are classified as operating leases.

When the Group is an intermediate lessor, it accounts for its interests in the head lease and the sublease separately. The sublease is classified as a finance or operating lease by reference to the right-of-use asset arising from the head lease.

For operating leases, rental income is recognised on a straight-line basis over the term of the relevant lease.

### ***Taxation***

#### ***Current Tax***

Current income tax assets and liabilities are measured at the amount expected to be recovered from or paid to the taxation authorities. The tax rates and tax laws used to compute the amount are those that are enacted or substantively enacted, at the reporting date in the countries where the Group operates and generates taxable income.

Current income tax relating to items recognised outside profit or loss is recognised outside profit or loss (either in other comprehensive income or in equity). Current tax items are recognised in correlation to the underlying transaction either in OCI or directly in equity. Management periodically evaluates positions taken in the tax returns with respect to situations in which applicable tax regulations are subject to interpretation and establishes provisions where appropriate.

#### ***Deferred Tax***

Deferred income tax is provided in full, using the liability method, on temporary differences arising between the tax bases of assets and liabilities and their carrying amounts in the financial statements. Deferred tax assets are recognised and carried forward only if it is probable that sufficient future taxable income will be available against which such deferred tax assets can be realised. Deferred tax assets and liabilities are measured at the tax rates that have been enacted or substantively enacted as on the balance sheet date. Deferred tax assets and deferred tax liabilities are offset when there is a legally enforceable right to set off assets against liabilities representing current tax. Current and deferred tax is recognised in profit and loss, except to the extent that it relates to items recognised in other comprehensive income. In this case, the tax is also recognised in other comprehensive income.

The carrying amount of deferred tax assets is reviewed at the end of each reporting period and reduced to the extent that it is no longer probable that sufficient taxable profits will be available to allow all or part of the asset to be recovered.

#### ***Employee Stock Options***

The Group has accounted for the share based payment for employees in respect of Group's ESOP - based on the IND AS 102 " Share-based payments" and Guidance Note on "Accounting for Employees Share Based Payment" issued by ICAI ("Guidance Note"). The Group follows the Fair Market Value Method (calculated on the basis of Black-Scholes method) to account for compensation expenses arising from issuance of stock options to the employees and has recognized the services received in an equity-settled employee share-based payment plan as an expense when it receives the services, with a corresponding credit to Stock Options Outstanding Account. Further, employees compensation cost recognized earlier on grant of options is reversed in the year when the Options are surrendered by the employee.

#### ***Borrowings and Borrowing Costs***

Borrowings are recognised initially at fair value, net of transaction costs incurred. Borrowings are subsequently stated at amortised cost. Any difference between the proceeds (net of transaction costs) and the redemption value is recognised in the income statement over the period of the borrowings using the effective interest rate method. Borrowings are classified as current liabilities unless the Group has an unconditional right to defer settlement of the liability for at least 12 months after the reporting date.

Borrowing costs directly attributable to the acquisition, construction or production of qualifying assets, which are assets that necessarily take a substantial period of time to get ready for their intended use or sale, are added to the cost of those assets, until such time as the assets are substantially ready for their intended use or sale.

Interest income earned on the temporary investment of specific borrowings, pending their expenditure on qualifying assets, is deducted from the borrowing costs eligible for capitalisation.

All other borrowing costs are recognised in consolidated statement of profit and loss in the period in which they are incurred.

## ***Impairment of Assets***

### ***Non-Financial Assets***

Intangible assets and property, plant and equipment are evaluated for recoverability whenever events or changes in circumstances indicate that their carrying amounts may not be recoverable. For the purpose of impairment testing, the recoverable amount (i.e. the higher of the fair value less cost to sell and the value-in-use) is determined on an individual asset basis unless the asset does not generate cash flows that are largely independent of those from other assets. In such cases, the recoverable amount is determined for the CGU to which the asset belongs.

If such assets are considered to be impaired, the impairment to be recognized in the consolidated statement of profit and loss is measured by the amount by which the carrying value of the assets exceeds the estimated recoverable amount of the asset. An impairment loss is reversed in the statement of profit and loss if there has been a change in the estimates used to determine the recoverable amount. The carrying amount of the asset is increased to its revised recoverable amount, provided that this amount does not exceed the carrying amount that would have been determined (net of any accumulated amortization or depreciation) had no impairment loss been recognized for the asset in prior years.

### ***Financial Assets***

The Group recognizes loss allowances using the expected credit loss (ECL) model for the financial assets which are not fair valued through profit or loss.

Loss allowance for trade receivables with no significant financing component is measured at an amount equal to lifetime ECL.

### ***Cash and Cash Equivalents***

Cash and cash equivalents includes cash and cheques in hand, current accounts and fixed deposit accounts with banks with original maturities of three months or less that are readily convertible to known amounts of cash and which are subject to an insignificant risk of changes in value.

### ***Cash Flow Statement***

Cash flows are reported using the indirect method, whereby a profit before tax is adjusted for the effects of transactions of non-cash nature and any deferrals or accruals of past or future cash receipts or payments. The cash flows from operating, financing and investing activities of the Group are segregated.

### ***Provisions and Contingencies***

Provisions are recognised when the Group has a present legal or constructive obligation as a result of past events, for which it is probable that an outflow of resources embodying economic benefits will be required to settle the obligation and a reliable estimate of the amount can be made.

Provisions are measured at the present value of management's best estimate of the expenditure required to settle the present obligation at the end of the reporting period. The discount rate to determine the present value is a pre-tax rate that reflects current market assessments of the time value of money and the risks specific to the liability. The increase in the provision due to the passage of time is recognised as interest expense.

Contingent liabilities are disclosed when there is a possible obligation arising from past events, the existence of which will be confirmed only by the occurrence or non-occurrence of one or more uncertain future events not wholly within the control of the Group or a present obligation that arises from past events where it is either not probable that an outflow of resources will be required to settle or a reliable estimate of the amount cannot be made.

### ***Derivative Financial Instruments and Hedge Accounting***

#### ***Cash Flow Hedge***

The Group enters into derivative financial instruments such as foreign exchange forward and option contracts to

mitigate the risk of changes in exchange rates on foreign currency exposures.

The effective portion of changes in the fair value of the hedging instruments is recognized in other comprehensive income and accumulated in the cash flow hedging reserve. Such amounts are reclassified in to the consolidated statement of profit or loss when the related hedge items affect profit or loss. Any ineffective portion of changes in the fair value of the derivative or if the hedging instrument no longer meets the criteria for hedge accounting, is recognized immediately in the statement of profit and loss.

Any derivative that is either not designated a hedge, or is so designated but is ineffective as per Ind AS 109, is categorized as a financial instruments at fair value through profit or loss.

### ***Dividend to Equity Holders of the Group***

The Group recognises a liability to make cash or non-cash distributions to equity holders of the Group when the distribution is authorised and the distribution is no longer at the discretion of the Group. As per the Corporate laws in India, a distribution is authorised when it is approved by the shareholders. A corresponding amount is recognised directly in other equity.

### ***Segment Reporting***

Operating segments are reported in a manner consistent with the internal reporting provided to the chief operating decision-maker.

### ***Earnings Per Share***

Earnings per share is calculated by dividing the profit attributable to owners of the Group by the weighted average number of equity shares outstanding during the financial year.

For the purpose of calculating diluted earnings per share, the net profit or loss for the year attributable to equity shareholders and the weighted average number of shares outstanding during the year are adjusted for the effects of all dilutive potential equity shares.

## **PRINCIPAL COMPONENTS OF INCOME AND EXPENDITURE**

### **Income**

Our total income comprise (i) revenue from operations; and (ii) other income.

#### ***Revenue from Operations***

Revenue from operations comprise (i) sale of goods (consisting of finished goods and scrap); (ii) sale of services; and (iii) other operating revenues (export incentives, amortisation of deferred government grants and revenue from consignment sales).

#### ***Other Income***

Other income includes (i) interest income, comprising of interest and net gain on investments carried at fair value through profit and loss; and (ii) other, comprising of net gain on fair valuation of financial instruments, rental income, lease receipts, insurance claim recoveries, profit on sale of fixed assets, proceeds from Paycheck Protection Program from the United States government on account of COVID-19 fiscal measures and miscellaneous receipts.

### **Expenses**

Our expenses comprise (i) cost of materials consumed; (ii) changes in inventories of finished goods, work-in-progress, stock-in-trade and scrap; (iii) employee benefits expenses; (iv) finance costs; (v) depreciation and amortisation expenses; and (vi) other expenses.

#### ***Costs of Materials Consumed***

Cost of material consumed consists of inventory at the beginning of the year, add purchases, less inventories at the end of the year.

### ***Changes in inventories of finished goods, work-in-progress, stock-in-trade and scrap***

Changes in inventories consists of (i) inventories at the end of the year (finished goods, work-in-progress and scrap) and (ii) inventories at the beginning of the year (finished goods, work-in-progress and scrap).

### ***Employee Benefits Expense***

Employee benefits expense primarily comprises (i) salaries and wages; (ii) contribution to provident and other funds; (iii) expense on employee stock option scheme; and (iv) staff welfare expenses. As of December 31, 2021, we had 2,143 full-time employees.

### ***Finance Costs***

Finance cost refers to (i) interest; (ii) bill discounting charges; (iii) interest on lease liabilities; and (iv) other borrowing costs consisting of bank charges.

### ***Depreciation and Amortization Expense***

Depreciation and amortisation expenses comprise (i) depreciation on tangible assets; (ii) depreciation of right-of-use assets; and (iii) amortisation of intangible assets.

### ***Other Expenses***

Other expenses primarily comprises: (i) stores, spares and tools consumed incurred towards manufacture of goods; (ii) sub-contracting expenses incurred towards the processes outsourced for completion of the manufacturing of our products; (iii) power, fuel and water expenses incurred towards manufacture of goods and power supply for administrative section of the facilities; (iv) cartage, freight and forwarding incurred towards transportation of input material including job work and transportation of finished goods; (v) air freight incurred towards transportation of finished goods on an expedited basis or transporting smaller quantities of samples to customers; (vi) repair and maintenance expenses, incurred towards building, plant and machinery and others; and (vii) exchange differences (net).

## **RESULTS OF OPERATION FOR THE NINE MONTHS ENDED DECEMBER 31, 2021**

<b>Particulars</b>	<b>Nine months ended December 31, 2021</b>	
	<b>(₹ million)</b>	<b>Percentage of total income</b>
<b>Revenue</b>		
Revenue from operations	8,808.92	99.63%
Other income	32.97	0.37%
<b>Total Income</b>	<b>8,841.89</b>	<b>100.00%</b>
<b>Expenses</b>		
Cost of materials consumed	3,862.24	43.68%
Changes in inventories of finished goods, work-in-progress, stock-in-trade and scrap	(1,121.17)	(12.68)%
Employee benefits expense	1,605.86	18.16%
Finance cost	42.28	0.48%
Depreciation and amortization expense	271.66	3.07%
Other expenses	2,481.48	28.07%
<b>Total expenses</b>	<b>7,142.35</b>	<b>80.78%</b>
<b>Restated profit before tax</b>	<b>1,699.54</b>	<b>19.22%</b>
<b>Tax expense</b>		
Current tax	512.01	5.79%
MAT credit	-	-
Deferred tax charge / (benefit)	(35.83)	(0.41)%
<b>Total Tax Expense</b>	<b>476.18</b>	<b>5.38%</b>
<b>Restated profit for the period</b>	<b>1,223.36</b>	<b>13.84%</b>



Particulars	Nine months ended December 31, 2021	
	(₹ million)	Percentage of total income
<b>Restated other comprehensive income / (loss)</b>		
<b>Items that will not be reclassified to profit or loss</b>		
Re-measurement gains/(losses) on defined benefit plans	(12.24)	(0.14)%
Income tax relating to items that will not be reclassified to profit/loss	3.08	0.03%
<b>Items that will be reclassified to profit or loss</b>		
Effective portion of cash flow hedge	10.06	0.11%
Exchange differences in translating the financial statements of foreign operations	(14.83)	(0.17)%
Income tax relating to items that will be reclassified to profit/loss	(2.53)	(0.03)%
<b>Restated other comprehensive income / (loss) for the period / year, net of tax</b>	(16.46)	(0.19)%
<b>Restated total comprehensive income for the period / year</b>	<b>1,206.90</b>	<b>13.65%</b>

## Income

Total income was ₹ 8,841.89 million in the nine months ended December 31, 2021.

### *Revenue from Operations*

Revenue from operations was ₹ 8,808.92 million in the nine months ended December 31, 2021. Sale of products (finished goods (net of returns, rebate, etc.)) was ₹ 8,445.96 million, and scrap was ₹ 307.51 million. Other operating revenues was ₹ 55.45 million, consisting of ₹ 48.38 million from export incentives, ₹ 0.30 million from amortisation of deferred government grants, and ₹ 6.77 million from revenue from consignment sales.

Local Deliveries contributed to 25.10%, Direct Exports contributed to 31.14% and Warehouse Sales contributed to 39.64% of our revenue from operations in the nine months ended December 31, 2021. International Sales accounted for 81.45% of our revenue from operations during this period.

### *Other Income*

Other income was ₹ 32.97 million in the nine months ended December 31, 2021, consisting of interest of ₹ 8.53 million, net gain on investments carried at fair value through profit and loss of ₹ 0.32 million, net gain on fair valuation of financial instruments of ₹ 0.05 million, lease receipts of ₹ 2.12 million, insurance claim recoveries of ₹ 0.01 million, employee retention credit of ₹ 11.09 million, and miscellaneous receipts of ₹ 10.85 million.

## Expenses

Total expenses was ₹ 7,142.35 million in the nine months ended December 31, 2021.

### *Cost of Materials Consumed and Changes in Inventories of Finished Goods, Work-in-Progress, Stock-in-Trade and Scrap*

Cost of materials consumed was ₹ 3,862.24 million in the nine months ended December 31, 2021, consisting of inventory at the beginning of the year of ₹ 488.40 million, and purchases of ₹ 3,859.54 million, less inventory at the end of the year of ₹ 485.70 million.

Changes in inventories was ₹ (1,121.17) million in the nine months ended December 31, 2021, consisting of inventories at the end of the year of ₹ 3,723.17 million (i.e., finished goods of ₹ 2,758.81 million, work-in-progress of ₹ 955.17 million and scrap of ₹ 9.19 million), and inventories at the beginning of the year of ₹ 2,602.00 million (i.e., finished goods of ₹ 1,724.01 million, work-in-progress of ₹ 870.86 million and scrap of ₹ 7.13 million).

### *Employee Benefits Expenses*

Employee benefit expenses were ₹ 1,605.86 million in the nine months ended December 31, 2021. Salaries and wages was ₹ 1,477.05 million in the nine months ended December 31, 2021. Consequently, contribution to provident fund was ₹ 53.26 million in the nine months ended December 31, 2021. Expense on employee stock option scheme and staff welfare expenses were ₹ 7.85 million and ₹ 67.70 million, respectively, in the nine months ended December 31, 2021.

#### ***Finance Costs***

Finance cost was ₹ 42.28 million in the nine months ended December 31, 2021. Interest was ₹ 22.83 million in the nine months ended December 31, 2021; interest on lease liabilities was ₹ 11.59 million in the nine months ended December 31, 2021; and other borrowing cost (bank charges) was ₹ 7.86 million in the nine months ended December 31, 2021.

#### ***Depreciation and Amortization Expense***

Depreciation and amortization expenses was ₹ 271.66 million in the nine months ended December 31, 2021. Depreciation of tangible assets was ₹ 198.78 million in the nine months ended December 31, 2021; depreciation of right-of-use assets was ₹ 55.59 million in the nine months ended December 31, 2021; and amortisation of intangible assets was ₹ 17.29 million in the nine months ended December 31, 2021.

#### ***Other Expenses***

Other expenses was ₹ 2,481.48 million in the nine months ended December 31, 2021, primarily due to stores, spares and tools consumed, which was ₹ 546.75 million in the nine months ended December 31, 2021, sub-contracting expenses, which was ₹ 542.14 million in the nine months ended December 31, 2021; power and fuel charges, which was ₹ 354.61 million in the nine months ended December 31, 2021; cartage, freight and forwarding, which was ₹ 656.81 million in the nine months ended December 31, 2021; air freight, which was ₹ 81.07 million in the nine months ended December 31, 2021; repairs and maintenance (plant and machinery) which was ₹ 97.19 million in the nine months ended December 31, 2021; repairs and maintenance (others) which was ₹ 79.21 million in the nine months ended December 31, 2021; and exchange differences (net), which was ₹ (110.15) million in the nine months ended December 31, 2021.

#### **Restated Profit before Tax**

For the reasons discussed above, restated profit before tax was ₹ 1,699.54 million in the nine months ended December 31, 2021.

#### **Tax Expense**

Current tax was ₹ 512.01 million in the nine months ended December 31, 2021; deferred tax credit was ₹ 35.83 million in the nine months ended December 31, 2021.

#### **Restated Profit for the Period**

For the various reasons discussed above, we recorded a profit for the period of ₹ 1,223.36 million in the nine months ended December 31, 2021.

#### **Restated Total Comprehensive Income for the Period, Net of Tax**

Total comprehensive income for the period, net of tax was ₹ 1,206.90 million in the nine months ended December 31, 2021.

#### **Earnings before Interest, Taxes, Depreciation and Amortization (EBITDA)**

EBITDA was ₹ 2,013.48 million in the nine months ended December 31, 2021, while EBITDA margin (EBITDA as a percentage of our revenue from operations) was 22.86% in the nine months ended December 31, 2021.

#### **RESULTS OF OPERATIONS FOR FISCAL 2019, 2020 AND 2021**

The following table sets forth certain information with respect to our results of operations on a consolidated basis for Fiscal 2019, 2020 and 2021:

Particulars	2019		Fiscal 2020		2021	
	(₹ million)	Percentage of total income	(₹ million)	Percentage of total income	(₹ million)	Percentage of total income
<b>Revenue</b>						
Revenue from operations	10,605.66	99.82%	9,072.20	96.63%	9,031.42	95.30%
Other income	19.12	0.18%	316.18	3.37%	445.47	4.70%
<b>Total Income</b>	<b>10,624.78</b>	<b>100.00%</b>	<b>9,388.38</b>	<b>100.00%</b>	<b>9,476.89</b>	<b>100.00%</b>
<b>Expenses</b>						
Cost of materials consumed	4,282.84	40.31%	3,323.20	35.40%	3,381.77	35.68%
Changes in inventories of finished goods, work-in-progress, stock-in-trade and scrap	(559.60)	(5.27)%	(35.34)	-0.38%	147.13	1.55%
Employee benefits expense	2,217.42	20.87%	2,117.62	22.56%	1,854.48	19.57%
Finance cost	181.98	1.71%	179.65	1.91%	81.07	0.86%
Depreciation and amortization expense	300.96	2.83%	354.42	3.78%	372.59	3.93%
Other expenses	3,285.64	30.92%	2,704.80	28.81%	2,454.25	25.90%
<b>Total expenses</b>	<b>9,709.24</b>	<b>91.38%</b>	<b>8,644.35</b>	<b>92.07%</b>	<b>8,291.29</b>	<b>87.49%</b>
<b>Restated profit before tax</b>	<b>915.54</b>	<b>8.62%</b>	<b>744.03</b>	<b>7.93%</b>	<b>1,185.60</b>	<b>12.51%</b>
<b>Tax expense</b>						
Current tax	203.76	1.92%	127.53	1.36%	245.54	2.59%
MAT credit	(4.60)	(0.04)%	19.06	0.20%	-	-
Deferred tax	20.41	0.19%	(28.98)	(0.31)%	16.20	0.17%
<b>Total Tax Expense</b>	<b>219.57</b>	<b>2.06%</b>	<b>117.61</b>	<b>1.25%</b>	<b>261.74</b>	<b>2.76%</b>
<b>Restated profit for the year</b>	<b>695.97</b>	<b>6.55%</b>	<b>626.42</b>	<b>6.67%</b>	<b>923.86</b>	<b>9.75%</b>
<b>Restated other comprehensive income / (loss)</b>						
<b>Items that will not be reclassified to profit or loss</b>						
Re-measurement gains / (losses) of defined benefit plans	(10.60)	(0.10)%	9.45	0.10%	0.69	0.01%
Income tax relating to items that will not be reclassified to profit or loss	3.50	0.03%	(2.41)	(0.03)%	(0.17)	0.00%
<b>Items that will be reclassified to profit or loss</b>						
Effective portion of cash flow hedge	14.70	0.14%	(69.19)	(0.74)%	89.87	0.95%
Exchange differences in translating the financial statements of foreign operations	(73.63)	(0.69)%	(101.55)	(1.08)%	(43.50)	(0.46)%
Income tax relating to items that will be reclassified to profit / loss	(5.14)	(0.05)%	17.41	0.19%	(22.62)	(0.24)%
<b>Restated other comprehensive income / (loss) for the year, net of tax</b>	<b>(71.17)</b>	<b>(0.67)%</b>	<b>(146.29)</b>	<b>(1.56)%</b>	<b>24.27</b>	<b>0.26%</b>
<b>Restated total comprehensive income for the year, net of tax</b>	<b>624.80</b>	<b>5.88%</b>	<b>480.13</b>	<b>5.11%</b>	<b>948.13</b>	<b>10.00%</b>

## FISCAL 2021 COMPARED TO FISCAL 2020

### Income

Total income increased by 0.94% from ₹ 9,388.38 million in Fiscal 2020 to ₹ 9,476.89 million in Fiscal 2021, primarily due to increase in scrap sales and one time proceeds from Paycheck Protection Programme by the US government to re-imburse certain qualifying expenses incurred by us during COVID-19 pandemic for our operations in the United States.

### Revenue from Operations

Revenue from operations decreased by 0.45%, from ₹ 9,072.20 million in Fiscal 2020 to ₹ 9,031.42 million in Fiscal 2021. Sale of products increased by 0.07%, from ₹ 8,907.36 million in Fiscal 2020 to ₹ 8,913.42 million in Fiscal 2021. There was a marginal decrease in finished goods sales (net of returns, rebate etc) by 0.43%, from ₹ 8,726.09 million in Fiscal 2020 to ₹ 8,688.64 million in Fiscal 2021, offset by an increase in scrap sales by 37.13%, from ₹ 163.91 million in Fiscal 2020 to ₹ 224.78 million in Fiscal 2021. There was a one-off sale of service to our Subsidiary, UOI for implementation of their enterprise resource planning system for an amount of ₹ 17.36 million in Fiscal 2020. Other operating revenues also decreased by 28.42%, from ₹ 164.84 million in Fiscal 2020 to ₹ 118.00 million in Fiscal 2021. Export incentives decreased by 31.04%, from ₹ 164.44 million in Fiscal 2020 to ₹ 113.40 million in Fiscal 2021 on account of discontinuation of the MEIS from December 31, 2020, and a decrease in amortisation of deferred government grants by 2.50%, from ₹ 0.40 million in Fiscal 2020 to ₹ 0.39 million in Fiscal 2021. Revenue from consignment sales was categorised separately in Fiscal 2021 and increased from nil in Fiscal 2020 to ₹ 4.21 million in Fiscal 2021.

Contribution of Local Deliveries as a percentage of our revenue from operations decreased from 32.47% in Fiscal 2020 to 28.20% in Fiscal 2021, while contribution of Direct Exports as a percentage of our revenue from operations increased from 22.76% in Fiscal 2020 to 26.89%, and contribution of Warehouse Sales as a percentage of our revenue from operations increased from 40.95% in Fiscal 2020 to 41.11% in Fiscal 2021. Contribution of International Sales as a percentage of our revenue from operations decreased from 83.55% in Fiscal 2020 to 80.33% in Fiscal 2021.

### ***Other Income***

Other income increased substantially by 40.89%, from ₹ 316.18 million in Fiscal 2020 to ₹ 445.47 million in Fiscal 2021. There was a decrease in interest by 36.68%, from ₹ 12.35 million in Fiscal 2020 to ₹ 7.82 million in Fiscal 2021 on account of interest on income tax refund of ₹ 6.19 million received in Fiscal 2020. It was partially offset by an increase in net gain on investments carried at fair value through profit and loss amounting to ₹ 0.30 million in Fiscal 2021, compared to nil in Fiscal 2020. There was a gain in the rental income in Fiscal 2021 of ₹ 2.02 million on account of special waiver of lease rentals by lessors on account of the COVID-19 pandemic. Certain insurance claims were settled in Fiscal 2021 for an amount of ₹ 249.82 million in Fiscal 2021 compared to ₹ 231.79 million in Fiscal 2020. Non-recurring income was recognised from the proceeds of Paycheck Protection Program from the US government amounting to ₹ 160.87 million in Fiscal 2021 to our Subsidiary in the United States. Similarly, the refund of the employee retention credit to our Subsidiaries in the United States was recognised as other income amounting to ₹ 0.74 million in Fiscal 2021. Miscellaneous receipts increased by 212.19%, from ₹ 6.89 million in Fiscal 2020 to ₹ 21.51 million in Fiscal 2021. This was partially offset by a decrease in lease receipts by 2.84% from ₹ 2.46 million in Fiscal 2020 to ₹ 2.39 million in Fiscal 2021. There was also a one-off sale of property leading to profit from sale of fixed assets in Fiscal 2020 for an amount of ₹ 62.69 million.

### ***Expenses***

Total expenses decreased by 4.08% from ₹ 8,644.35 million in Fiscal 2020 to ₹ 8,291.29 million in Fiscal 2021 primarily on account of cost rationalization measures undertaken on account of the COVID-19 pandemic.

### ***Cost of Materials Consumed and Changes in Inventories of Finished Goods, Work-in-Progress, Stock-in-Trade and Scrap***

Cost of raw materials, including change in inventory consumed increased by 12.54% from ₹ 3,287.86 million in Fiscal 2020 to ₹ 3,528.90 million in Fiscal 2021 due to an increase in raw material prices (primarily steel) in India.

### ***Employee benefits expenses***

Employee benefit expenses decreased by 12.43%, from ₹ 2,117.62 million in Fiscal 2020 to ₹ 1,854.48 million in Fiscal 2021. Salaries were temporarily rationalized as a countermeasure to the unpredictable business situation on account of the COVID-19 pandemic. Migration of temporary labour workforce resulted in decrease in availability of labour. These factors resulted in a decrease in salaries and wages, by 13.04%, from ₹ 1,982.96 million in Fiscal 2020 to ₹ 1,724.46 million in Fiscal 2021. There was a corresponding decrease in contribution towards statutory dues such as provident fund which declined by 2.86%, from ₹ 64.31 million in Fiscal 2020 to ₹ 62.47 million in Fiscal 2021 and staff welfare that decreased by 1.52% from ₹ 64.50 million in Fiscal 2020 to ₹ 63.52 million in Fiscal 2021. Employee stock option expense was pro-rated over a period based on the vesting period of the grants during the year. Employee stock option expense was ₹ 5.85 million in Fiscal 2020 compared with ₹ 4.03 million in Fiscal 2021.

### ***Finance Costs***

Finance costs decreased by 54.87%, from ₹ 179.65 million in Fiscal 2020 to ₹ 81.07 million in Fiscal 2021 due to a decrease in interest paid, by 60.58%, from ₹ 135.99 million in Fiscal 2020 to ₹ 53.61 million in Fiscal 2021 on account of an overall reduction in our debt obligations. Bank charges also decreased by 5.79%, from ₹ 8.81 million in Fiscal 2020 to ₹ 8.30 million in Fiscal 2021. We also discontinued a bill discounting facility with certain customers resulting in a decrease in bill discounting charges by 93.52%, from ₹ 14.82 million in Fiscal 2020 to ₹ 0.96 million in Fiscal 2021. There was also a decrease in interest on lease liabilities by 9.14%, from ₹ 20.03 million in Fiscal 2020 to ₹ 18.20 million in Fiscal 2021 due to the discontinuation of a lease for our corporate office in Noida, Uttar Pradesh.

### ***Depreciation and Amortization Expense***

Depreciation and amortization expense increased marginally by 5.13%, from ₹ 354.42 million in Fiscal 2020 to ₹ 372.59 million in Fiscal 2021, primarily due to an increase in depreciation of tangible assets by 4.91%, from ₹ 258.11 million in Fiscal 2020 to ₹ 270.78 million in Fiscal 2021 on account of investment in tangible assets during Fiscal 2020 and Fiscal 2021. There was also an increase in amortisation of intangible assets, by 94.93%, from ₹ 11.04 million in Fiscal 2020 to ₹ 21.52 million in Fiscal 2021 on account of capitalization of the enterprise resource planning system. This is partially offset by a decrease in depreciation of right-of-use assets by 5.84%, from ₹ 85.27 million in Fiscal 2020 to ₹ 80.29 million in Fiscal 2021 as a result of discontinuation of the lease for our Corporate Office at Noida, Uttar Pradesh.

### ***Other Expenses***

Other expenses decreased by 9.26%, from ₹ 2,704.80 million in Fiscal 2020 to ₹ 2,454.25 million in Fiscal 2021, resulting from a decrease in stores, spares and tools consumed by 2.04%, from ₹ 516.93 million in Fiscal 2020 to ₹ 506.37 million in Fiscal 2021 on account of reduction in manufacturing volumes at UOI in the United States. This also caused a reduction in sub-contracting expenses, by 14.43%, from ₹ 629.14 million in Fiscal 2020 to ₹ 538.30 million in Fiscal 2021. The mandatory lockdown announced during the first quarter of Fiscal 2021 resulted in a reduction in power, fuel and water expenses by 2.66%, from ₹ 342.50 million in Fiscal 2020 to ₹ 333.39 million in Fiscal 2021. As an additional countermeasure, we vacated one warehouse of our Subsidiary, UOI in the United States, resulting in a substantial reduction in rent, by 34.22%, from ₹ 71.54 million in Fiscal 2020 to ₹ 47.06 million in Fiscal 2021. Travel restrictions during the pandemic resulted in negligible travel reducing travelling and conveyance expenses by 87.17%, from ₹ 51.53 million in Fiscal 2020 to ₹ 6.61 million in Fiscal 2021. There was also a reduction in rates and taxes by 22.37%, from ₹ 32.64 million in Fiscal 2020 to ₹ 25.34 million in Fiscal 2021 on account of reclassification of customs duty paid from the rates and taxes to material cost in UUL; a reduction in insurance expenses by 20.50%, from ₹ 41.70 million in Fiscal 2020 to ₹ 33.15 million in Fiscal 2021 on account of reducing the insurance coverage due to the discontinuation of one warehouse facility of our Subsidiary, UOI in the United States, and sale of property of UUL in the United States. Discretionary cost control was exercised in repairs and maintenance. Repair expenses of plant and machinery reduced by 10.21%, from ₹ 117.89 million in Fiscal 2020 to ₹ 105.85 million in Fiscal 2021 and other repair and maintenance charges also reduced by 10.17%, from ₹ 107.35 million in Fiscal 2020 to ₹ 96.43 million in Fiscal 2021. Expenses incurred on repair and reconstruction by UOI due to a fire the incident of fire were ₹ 75.25 million in Fiscal 2021 and ₹ 218.34 million in Fiscal 2020.

The lockdowns in India on account of COVID-19 pandemic and reduced operations due to limitation on attendance at our facilities, led to an order backlog with our customers, leading to an increase in air freight by 293.14% from ₹ 33.38 million in Fiscal 2020 to ₹ 131.23 million in Fiscal 2021. The cartage, freight and forwarding expenses increased by 5.87%, from ₹ 384.50 million in Fiscal 2020 to ₹ 407.07 million in Fiscal 2021, primarily on account of an increase in freight rates.

### **Restated Profit Before Tax**

For the reasons discussed above, profit before tax was ₹ 1,185.60 million in Fiscal 2021 to ₹ 744.03 million in Fiscal 2020.

### **Tax Expense**

Current tax increased by 92.53%, from ₹ 127.53 million in Fiscal 2020 to ₹ 245.54 million in Fiscal 2021 on account of an increase in profit before tax. MAT credit amounting to ₹ 19.06 million in Fiscal 2020 was utilised completely during the year. Deferred tax increased by 155.90%, from ₹ (28.98) million in Fiscal 2020 to ₹ 16.20

million in Fiscal 2021 on account of change in income tax rate for Fiscal 2021, insurance income tax deferral in our Subsidiary in the United States, and also on account of the impact of adoption of Ind AS 116 in Fiscal 2019.

### **Restated Profit/(Loss) for the Year**

For the various reasons discussed above, we recorded a profit after tax for the year of ₹ 923.86 million in Fiscal 2021 compared to ₹ 626.42 million in Fiscal 2020.

### **Restated Total Comprehensive Income for the Year, Net of Tax**

Restated total comprehensive income for the year was ₹ 948.13 million in Fiscal 2021 compared to ₹ 480.13 million in Fiscal 2020.

### **Earnings before Interest, Taxes, Depreciation and Amortization (EBITDA)**

EBITDA was ₹ 1,639.26 million in Fiscal 2021 compared to ₹ 1,278.10 million in Fiscal 2020, while EBITDA margin (EBITDA as a percentage of our revenue from operations) was 18.15% in Fiscal 2021 compared to 14.09% in Fiscal 2020. The increase in our EBITDA was primarily on account of reduction and rationalization in employee benefit expenses, increase in proportion of sales through Direct Exports and Warehouse Sales and reduction of manufacturing activities in the United States.

## **FISCAL 2020 COMPARED TO FISCAL 2019**

### **Income**

Total income decreased by 11.64% from ₹ 10,624.78 million in Fiscal 2019 to ₹ 9,388.38 million in Fiscal 2020, primarily due to weakness in end-market demand and onset of COVID-19 pandemic related disruptions.

### **Revenue from Operations**

Revenue from operations decreased by 14.46%, from ₹ 10,605.66 million in Fiscal 2019 to ₹ 9,072.20 million in Fiscal 2020. Sale of products decreased by 14.35%, from ₹ 10,399.68 million in Fiscal 2019 to ₹ 8,890.00 million in Fiscal 2020 owing to reduced end-market demand. The decrease in sale of products comprised a decrease in finished goods (net of returns, rebate etc) sales, by 14.19%, from ₹ 10,169.45 million in Fiscal 2019 to ₹ 8,726.09 million in Fiscal 2020, and a decrease in scrap sales by 28.81%, from ₹ 230.23 million in Fiscal 2019 to ₹ 163.91 million in Fiscal 2020. There was a one-time sale of services of ₹ 17.36 million in Fiscal 2020. Other operating revenues also decreased by 19.97%, from ₹ 205.98 million in Fiscal 2019 to ₹ 164.84 million in Fiscal 2020, on account of a decrease in export incentives, by 20.16%, from ₹ 205.97 million in Fiscal 2019 to ₹ 164.44 million in Fiscal 2020, partially offset by an increase in amortisation of deferred government grants by 390.00%, from ₹ 0.01 million in Fiscal 2019 to ₹ 0.40 million in Fiscal 2020.

Contribution of Local Deliveries as a percentage of our revenue from operations increased from decreased from 34.19% in Fiscal 2020 to 32.47%, while contribution of Direct Exports as a percentage of our revenue from operations decreased from 23.36% in Fiscal 2019 to 22.76% in Fiscal 2020, and contribution of Warehouse Sales as a percentage of our revenue from operations increased from 38.33% in Fiscal 2019 to 40.95% in Fiscal 2020. Contribution of International Sales as a percentage of our revenue from operations decreased from 83.26% in Fiscal 2019 to 83.55% in Fiscal 2020.

### **Other Income**

Other income increased by 1,553.66%, from ₹ 19.12 million in Fiscal 2019 to ₹ 316.18 million in Fiscal 2020, due to an increase in interest income by 150.51%, from ₹ 4.93 million in Fiscal 2019 to ₹ 12.35 million in Fiscal 2020 that includes interest on income tax refund amounting to ₹ 6.19 million. There was also an increase in others, consisting of an increase in lease receipts from nil in Fiscal 2019 to ₹ 2.46 million in Fiscal 2020 on account of leasing out space to a sub-contractor for job work. There was a receipt of ₹ 231.79 million in Fiscal 2020 on account of payout received from the insurance company for the insurance claim in relation to the fire incident that occurred at UOI's facility and at one unit in Ludhiana, Punjab, facility of our Company. There was an increase in profit on sale of fixed assets (net) from ₹ 0.20 million in Fiscal 2019 to ₹ 62.69 million in Fiscal 2020 on account of sale of immovable property owned by UUL, this was partially offset by a decrease in miscellaneous receipts from ₹ 13.99 million in Fiscal 2019 to ₹ 6.89 million in Fiscal 2020 due to reduction in tooling cost invoiced to customers.

## **Expenses**

Total expenses decreased from ₹ 9,709.24 million in Fiscal 2019 to ₹ 8,644.35 million in Fiscal 2020 primarily on account of lower production levels due to decline in the global agricultural and construction equipment markets and onset of the COVID-19 pandemic.

### ***Cost of Materials Consumed and Changes in Inventories of Finished Goods, Work-in-Progress, Stock-in-Trade and Scrap***

Our cost of raw materials and components consumed (which primarily consists of steel) including change in inventory, decreased by 11.69% to ₹ 3,287.86 million in Fiscal 2020 from ₹ 3,723.24 million in Fiscal 2019, primarily due to the reduction in overall production volumes owing to weakness in end-market demand and onset of COVID-19 pandemic.

### ***Employee benefits expenses***

Employee benefit expenses decreased by 4.50%, from ₹ 2,217.42 million in Fiscal 2019 to ₹ 2,117.62 million in Fiscal 2020. Salaries and wages decreased by 3.90%, from ₹ 2,063.35 million in Fiscal 2019 to ₹ 1,982.96 million in Fiscal 2020 on account of lesser production volumes due to reduced sales and reduction in headcount as part of cost control measures. Staff welfare expenses also decreased by 26.87%, from ₹ 88.20 million in Fiscal 2019 to ₹ 64.50 million in Fiscal 2020 on account of various cost saving and optimization measures implemented.

### ***Finance Costs***

Finance costs decreased by 1.28%, from ₹ 181.98 million in Fiscal 2019 to ₹ 179.65 million in Fiscal 2020 due to a decrease in interest by 7.97%, from ₹ 147.76 million in Fiscal 2019 to ₹ 135.99 million in Fiscal 2020 on account of reduction in overall debt. Other borrowing costs consisting of bank charges also decreased by 5.79%, from ₹ 10.93 million in Fiscal 2019 to ₹ 8.81 million in Fiscal 2020 on account of lower export sales.

This was partly offset by an increase in bill discounting charges by 17.71%, from ₹ 12.59 million in Fiscal 2019 to ₹ 14.82 million in Fiscal 2020 on account of additional bill discounting facility availed as part of our India operations, and an increase in interest in lease liabilities by 87.20%, from ₹ 10.70 million in Fiscal 2019 to ₹ 20.03 million in Fiscal 2020 on account of impact of adoption of Ind AS 116 that became applicable from April 1, 2019 on the building lease of our Subsidiary, UOI.

### ***Depreciation and Amortization Expense***

Depreciation and amortization expense increased by 17.76%, from ₹ 300.96 million in Fiscal 2019 to ₹ 354.42 million in Fiscal 2020. The increase in depreciation was primarily due to an increase in depreciation of tangible assets by 14.70%, from ₹ 225.02 million in Fiscal 2019 to ₹ 258.11 million in Fiscal 2020 primarily on account of increased depreciation expense on plant and machinery due to addition of capital assets during Fiscal 2019. There was an increase in depreciation of right-of-use assets by 22.34%, from ₹ 69.70 million in Fiscal 2019 to ₹ 85.27 million in Fiscal 2020 on account of inclusion of leased facility of UUL. The increase in amortisation of intangible assets, by 76.92%, from ₹ 6.24 million in Fiscal 2019 to ₹ 11.04 million in Fiscal 2020 was on account of implementation of new enterprise resource planning software in UOI.

### ***Other Expenses***

Other expenses decreased by 17.68%, from ₹ 3,285.64 million in Fiscal 2019 to ₹ 2,704.80 million in Fiscal 2020. The decrease in other expenses was primarily from a decrease in stores, spares and tools consumed by 23.45%, from ₹ 675.26 million in Fiscal 2019 to ₹ 516.93 million in Fiscal 2020 on account of reduction in overall production volumes, better operational efficiencies through inventory control resulting in reduction in stores, spares and tools consumed. There was a reduction in sub-contracting expenses by 28.47%, from ₹ 879.50 million in Fiscal 2019 to ₹ 629.14 million in Fiscal 2020 on account of reduction in the overall production levels resulting in surplus capacity available in-house. The cartage, freight and forwarding reduced by 20.16%, from ₹ 481.61 million in Fiscal 2019 to ₹ 384.50 million in Fiscal 2020 on account of lower sales and purchase volumes; air freight reduced by 85.16%, from ₹ 224.91 million in Fiscal 2019 to ₹ 33.38 million in Fiscal 2020 on account of focused efforts on reducing expedited delivery requirements. The exchange differences (net) improved by 212.75%, from loss of ₹ 29.01 million in Fiscal 2019 to a gain of ₹ (32.71) million in Fiscal 2020 on account of fluctuation in exchange rates during the year.

This reduction in expenses was partially offset by an increase in repairs and maintenance (plant and machinery) by 9.48%, from ₹ 107.68 million in Fiscal 2019 to ₹ 117.89 million in Fiscal 2020, an increase in repairs and maintenance (others), by 2.99%, from ₹ 104.23 million in Fiscal 2019 to ₹ 107.35 million in Fiscal 2020 on account of additional repairs carried out during the year; and an increase in legal and professional charges, by 18.19%, from ₹ 43.47 million in Fiscal 2019 to ₹ 51.38 million in Fiscal 2020.

### Restated Profit Before Tax

For the reasons discussed above, profit before tax was ₹ 744.03 million in Fiscal 2020 to ₹ 915.54 million in Fiscal 2019.

### Tax Expense

Current tax decreased by 37.41%, from ₹ 203.76 million in Fiscal 2019 to ₹ 127.53 million in Fiscal 2020 on account of lower revenues leading to lower profitability. MAT credit increased by 514.35% from ₹ (4.60) million in Fiscal 2019 to ₹ 19.06 million in Fiscal 2020. Deferred tax decreased by 241.99%, from ₹ 20.41 million in Fiscal 2019 to ₹ (28.98) million in Fiscal 2020 on account of opening adjustment of Ind AS 116 and change in tax rate in GFPL in Fiscal 2019 to 29.12% from and in Fiscal 2020 to 25.17%.

### Restated Profit/(Loss) for the Year

For the various reasons discussed above, we recorded a profit after tax for the year of ₹ 626.42 million in Fiscal 2020 compared to ₹ 695.97 million in Fiscal 2019.

### Restated Total Comprehensive Income for the Year, Net of Tax

Restated total comprehensive income for the year was ₹ 480.13 million in Fiscal 2020 compared to ₹ 624.80 million in Fiscal 2019.

### Earnings before Interest, Taxes, Depreciation and Amortization (EBITDA)

EBITDA was ₹ 1,278.10 million in Fiscal 2020 compared to ₹ 1,398.48 million in Fiscal 2019, while EBITDA margin (EBITDA as a percentage of our revenue from operations) was 14.09% in Fiscal 2020 compared to 13.19% in Fiscal 2019. The increase in EBITDA was primarily on account of reduction in employee benefit expenses and reduction in premium freight.

## LIQUIDITY AND CAPITAL RESOURCES

We have historically financed the expansion of our business and operations primarily through debt financing and funds generated from our operations. From time to time, we may obtain loan facilities to finance our short term working capital requirements.

### CASH FLOWS

The following table sets forth certain information relating to our cash flows in the periods indicated:

Particulars	2019	Fiscal 2020	2021	Nine months ended December 31, 2021
	(₹ million)			
Net cash flow from/(used in) operating activities	(56.51)	1,330.67	1,527.55	354.43
Net cash flows (used in)/from investing activities	(1,081.92)	(101.11)	(157.38)	(245.11)
Net cash flows (used in)/from financing activities	1,248.58	(1,232.14)	(1,414.23)	(82.20)

### Operating Activities

#### *Nine months ended December 31, 2021*

In the nine months ended December 31, 2021, net cash flow from operations was ₹ 354.43 million. Restated profit before tax was ₹ 1,699.54 million in the nine months ended December 31, 2021. Primary adjustments consisted of depreciation and amortisation expenses of ₹ 271.66 million; interest expenses, of ₹ 22.83 million; interest on



lease liabilities of ₹ 11.59 million; interest income of ₹ 8.53 million; deferred tax of ₹ (35.83) million; expense of employee stock option scheme of ₹ 7.85 million; loss on sale of property, plant and equipment of ₹ 0.93 million; unrealised foreign exchange gain of ₹ 27.40 million; and exchange difference on translation of assets and liabilities of ₹ (48.31) million.

Operating profit before working capital changes was ₹ 1,897.57 million in the nine months ended December 31, 2021. The main working capital adjustments in the nine months ended December 31, 2021, included an increase in inventories of ₹ 1,154.92 million; increase in other current assets of ₹ 48.24 million; and decrease in trade payables of ₹ 39.00 million. This was partially offset by an increase in other current liabilities of ₹ 22.95 million; an increase in current tax liabilities of ₹ 38.64 million, decrease in trade receivables of ₹ 76.29 million; decrease in current tax assets (net) of ₹ 44.22 million. Cash generated from operations in the nine months ended December 31, 2021 amounted to ₹ 830.61 million. Income tax paid amounted to ₹ 476.18 million.

### ***Fiscal 2021***

In Fiscal 2021, net cash from operations was ₹ 1,527.55 million. Net profit before tax was ₹ 1,185.60 million in Fiscal 2021. Adjustments primarily consisted of depreciation and amortisation expenses of ₹ 372.59 million; interest expenses of ₹ 53.61 million; unrealised foreign exchange gain of ₹ 32.85 million; and exchange difference on translation of assets and liabilities of ₹ (29.99) million.

Operating profit before working capital changes was ₹ 1,583.78 million in Fiscal 2021. The main working capital adjustments in Fiscal 2021, included an increase in trade receivables of ₹ 434.04 million. This was partially offset by an increase in trade payables of ₹ 374.11 million and decrease in inventories of ₹ 138.38 million; decrease in other current assets of ₹ 113.06 million. Cash generated from operations in Fiscal 2021 amounted to ₹ 1,789.29 million. Tax paid amounted to ₹ 261.74 million.

### ***Fiscal 2020***

In Fiscal 2020, net cash from operations was ₹ 1,330.67 million. Net profit before tax was ₹ 744.03 million in Fiscal 2020. Adjustments primarily consisted of depreciation and amortisation expenses of ₹ 354.42 million; and interest expenses of ₹ 135.99 million. This was partially offset by profit on sale of property, plant and equipment of ₹ 62.69 million; and exchange difference on translation of assets and liabilities of ₹ (147.19) million.

Operating profit before working capital changes was ₹ 1,046.21 million in Fiscal 2020. The main working capital adjustments in Fiscal 2020, included a decrease in inventories of ₹ 145.49 million; and a decrease in trade receivables of ₹ 288.45 million. This was partially offset by an increase in other current liabilities of ₹ 40.29 million. Cash generated from operations in Fiscal 2020 amounted to ₹ 1,448.28 million. Tax paid amounted to ₹ 117.61 million.

### ***Fiscal 2019***

In Fiscal 2019, net cash used in operations was ₹ (56.51) million. Net profit before tax was ₹ 915.54 million in Fiscal 2019. Adjustments primarily consisted of depreciation and amortisation expenses of ₹ 300.96 million; and interest expenses of ₹ 147.76 million. This was partially offset by exchange difference on translation of assets and liabilities of ₹ (106.86) million.

Operating profit before working capital changes was ₹ 1,261.01 million in Fiscal 2019. The main working capital adjustments in Fiscal 2019, included mainly an increase in inventories of ₹ 632.87 million; an increase in trade receivables of ₹ 339.45 million; decrease in trade payables of ₹ 144.24 million; and increase in current tax assets (net) of ₹ 30.10 million. This was partially offset by a decrease in non-current liabilities of ₹ 16.71 million. Cash generated from operations in Fiscal 2019 amounted to ₹ 142.00 million. Tax paid amounted to ₹ 198.51 million.

## **Investing Activities**

### ***Nine months ended December 31, 2021***

Net cash flow used in investing activities was ₹ 245.11 million in the nine months ended December 31, 2021, primarily on account of payments for purchase of plant, property and equipment and capital work in progress of ₹ 249.24 million, payments for purchase of intangible assets of ₹ 2.47 million, and investment in financial instrument of ₹ 5.08 million, which was marginally offset by proceeds from sale of property, plant and equipment of ₹ 3.15 million, and interest received of ₹ 8.53 million.

### ***Fiscal 2021***

Net cash flow used in investing activities was ₹ 157.38 million in Fiscal 2021, primarily on account of payments for purchase of plant, property and equipment and capital work in progress of ₹ 161.21 million, payments for purchase of intangible assets of ₹ 2.32 million, and investment in financial instrument of ₹ 12.50 million, which was marginally offset by proceeds from sale of property, plant and equipment of ₹ 10.83 million, and interest received of ₹ 7.82 million.

### ***Fiscal 2020***

Net cash flow used in investing activities was ₹ 101.11 million in Fiscal 2020, primarily on account of payments for purchase of plant, property and equipment and capital work in progress of ₹ 214.47 million, and payments for purchase of intangible assets of ₹ 30.26 million, which was offset to a certain extent by proceeds from sale of property, plant and equipment of ₹ 131.27 million, and interest received of ₹ 12.35 million.

### ***Fiscal 2019***

Net cash flow used in investing activities was ₹ 1,081.92 million in Fiscal 2019, primarily on account of payments for purchase of plant, property and equipment and capital work in progress of ₹ 1,079.90 million, and payments for purchase of intangible assets of ₹ 21.25 million, which was marginally offset by proceeds from sale of property, plant and equipment of ₹ 14.30 million, and interest received of ₹ 4.93 million.

## **Financing Activities**

### ***Nine months ended December 31, 2021***

Net cash used in financing activities was ₹ 82.20 million in the nine months ended December 31, 2021, primarily on account of proceeds from short term borrowings of ₹ 185.25 million, which was offset by decrease in lease liabilities of ₹ 42.06 million, interest on lease liabilities of ₹ 11.59 million, repayment of long term borrowings of ₹ 42.03 million, interest paid of ₹ 22.83 million, and payment of dividend on equity shares (including dividend distribution tax) of ₹ 148.94 million.

### ***Fiscal 2021***

Net cash used in financing activities was ₹ 1,414.23 million in Fiscal 2021, primarily on account of repayment of short term borrowings of ₹ 1,108.32 million, decrease in lease liabilities of ₹ 75.15 million, interest on lease liabilities of ₹ 18.20 million, repayment of long term borrowings of ₹ 158.95 million, and interest paid of ₹ 53.61 million.

### ***Fiscal 2020***

Net cash used in financing activities was ₹ 1,232.14 million in Fiscal 2020, primarily on account of repayment of short term borrowings of ₹ 707.91 million, decrease in lease liabilities of ₹ 43.89 million, interest on lease liabilities of ₹ 20.03 million, repayment of long term borrowings of ₹ 259.03 million, interest paid of ₹ 135.99 million and payment of dividend on equity shares (including dividend distribution tax) of ₹ 65.29 million.

### ***Fiscal 2019***

Net cash from financing activities was ₹ 1,248.58 million in Fiscal 2019, primarily on account of proceeds from short term borrowings of ₹ 766.36 million, proceeds from long term borrowings of ₹ 350.00 million, increase in lease liabilities of ₹ 462.92 million, which was partially offset by interest on lease liabilities of ₹ 10.70 million, repayment of long term borrowings of ₹ 117.83 million, interest paid of ₹ 147.76 million, and payment of dividend on equity shares (including dividend distribution tax) of ₹ 54.41 million.

## **INDEBTEDNESS**

As of December 31, 2021, we had total borrowings (consisting of non-current borrowings and current borrowings) of ₹ 1,277.85 million. Our total debt/equity ratio was 0.19 as of December 31, 2021. For further information on our indebtedness, see “*Financial Indebtedness*” on page 352.

The following table sets forth certain information relating to our outstanding indebtedness as of December 31, 2021, and our repayment obligations in the periods indicated:

Particulars	As of December 31, 2021				
	Total	Not later than 1 year	Payment due by period (₹ million)		
1-3 years			3 -5 years	More than 5 years	
<b>Non-Current Borrowings</b>					
Term loan from bank	14.99	-	14.99	-	-
Term loan from others	0.15	-	0.15	-	-
<b>Total Non-Current borrowings</b>	<b>15.14</b>	-	15.14	-	-
<b>Current Borrowings</b>					
Current maturities of long term borrowings	59.11	59.11	-	-	-
Working capital demand loan	1,335.33	1,335.33	-	-	-
<b>Total Current Borrowings</b>	<b>1,394.44</b>	<b>1,394.44</b>	-	-	-
<b>Total Borrowings</b>	<b>1,409.58</b>	<b>1,394.44</b>	<b>15.14</b>	-	-

## CONTINGENT LIABILITIES AND OFF-BALANCE SHEET ARRANGEMENTS

As of December 31, 2021, our contingent liabilities that have not been accounted for in our Restated Financial Statements, were as follows:

Particulars	Amount (₹ million)
<b>Claims against the company not acknowledged as debt</b>	
- Sales Tax Matters	2.51
- Excise Matters	0.21
- GST Matters	0.36
<b>Income Tax Matters</b>	59.74
<b>Sales Tax Liability against pending forms</b>	-
<b>Others</b>	
- Guarantees given on behalf of the company by banks	
(iv) Sales Tax Matters	0.03
(v) Pollution Control Board	0.05
(vi) Gas Connections	2.68
<b>Total</b>	<b>65.58</b>

For further information on our contingent liabilities, see “*Restated Financial Statements – Annexure V – Note 30*” on page 289. Except as disclosed in the Restated Financial Statements or elsewhere in this Draft Red Herring Prospectus, there are no off-balance sheet arrangements that have or are reasonably likely to have a current or future effect on our financial condition, revenues or expenses, results of operations, liquidity, capital expenditures or capital resources that we believe are material to investors.

## CONTRACTUAL OBLIGATIONS AND COMMITMENTS

We do not have any long-term commitments or material non-cancellable contractual commitments/contracts, including derivative contracts for which there were any material foreseeable losses.

The following table sets forth certain information relating to our future commitments:

Particulars	As of December 31, 2021				
	Total	Less than 1 year	Payment due by period (₹ million)		
1-3 years			3-5 years	More than 5 years	
Estimated amount of contracts remaining to be executed on Capital Accounts and not provided for (Net of Advances)	36.88	36.54	0.07	0.27	-
<b>Total</b>	<b>36.88</b>	<b>36.54</b>	<b>0.07</b>	<b>0.27</b>	-

For further information on our capital and other commitments, see “*Restated Financial Statements – Annexure V – Note 30*” on page 289.

## CAPITAL EXPENDITURES

In Fiscal 2019, 2020 and 2021, and in the nine months ended December 31, 2021, our capital expenditure towards additions to fixed assets were ₹ 796.30 million, ₹ 174.20 million, ₹ 224.96 million, and ₹ 211.98 million, respectively. The following table sets forth our fixed assets for the periods indicated:

Particulars	Fiscal 2019	Fiscal 2020	Fiscal 2021	For the nine months ended December 31, 2021
	(₹ million)			
Property, plant and equipment (Gross)	4,280.05	4,444.41	4,409.52	4,613.94
Capital Work in Progress	58.75	93.21	22.87	57.51
<b>Total</b>	<b>4,338.80</b>	<b>4,537.62</b>	<b>4,432.39</b>	<b>4,671.45</b>

For further information, see “*Restated Financial Statements – Annexure V – Note 3*” on page 247.

## RELATED PARTY TRANSACTIONS

We enter into various transactions with related parties in the ordinary course of business. These transactions principally include sale of goods and services to entities where any of our KMPs or their relatives have control or significant influence, sale of goods to subsidiaries and purchase of goods from subsidiaries, rent paid, sitting fees to Directors, dividends paid, salary and allowances, remuneration paid to KMPs, ESOP expenses, loan taken from related parties and loan repaid related parties and guarantees given to lenders against borrowings.

In Fiscal 2019, 2020 and 2021 and in the nine months ended December 31, 2021, the aggregate amount of such related party transactions was ₹ 164.98 million, ₹ 171.35 million, ₹ 108.95 million, and ₹ 215.69 million respectively. The percentage of the aggregate value of such related party transactions to our revenue from operations in Fiscal 2019, 2020 and 2021 and in the nine months ended December 31, 2021 was 1.56%, 1.89%, 1.21% and 2.45%, respectively.

For further information relating to our related party transactions, see “*Restated Financial Statements – Note 38*” on page 306.

## AUDITOR’S OBSERVATIONS

There are no qualifications, reservations and adverse remarks by our statutory auditors in our Restated Financial Statements.

## QUANTITATIVE AND QUALITATIVE DISCLOSURES ABOUT MARKET RISK

The Company’s activities expose it to market risk, liquidity risk and credit risk. The Company’s board of directors has overall responsibility for the establishment and oversight of the Company’s risk management framework.

### *Market Risk*

Market risk is the risk that the fair value of future cash flows of a financial instrument will fluctuate because of changes in market prices. Market prices are subject to commodity price risk, foreign exchange risk and interest rate risk.

The financial instruments that are affected by these include loans and borrowing, deposits, available-for-sale investments and derivative financial instruments. We, from time to time, undertake analysis in relation to the amount of our net debt, the ratio of fixed to floating interest rates of our debt and our financial instruments that are in foreign currencies. We use derivative financial instruments such as foreign exchange contracts to manage our exposures to foreign exchange fluctuations.

### *Interest rate risk*

Interest rate risk is the risk that the fair value or future cash flows of a financial instrument will fluctuate because of changes in market interest rates. Our Company's exposure to the risk of changes in market interest rates relates primarily to our long-term debt obligations with floating interest rates. The interest rate on remaining loans (except vehicle loans), although fixed, is subject to periodic review by lending banks / financial institutions in relation to their respective base lending rates, which may vary over a period result of any change in the monetary policy of the Reserve Bank of India.

#### *Foreign Currency Risk*

Foreign currency risk is the risk that the fair value or future cash flows of an exposure will fluctuate because of changes in foreign exchange rates. The Company's exposure to the risk of changes in foreign exchange rates relates primarily to the Company's export revenue and long term foreign currency borrowings.

#### *Commodity Price Risk*

Commodity price risk is the possibility of impact from changes in the prices of raw materials such as steel, which we use in the manufacture of our products. While we seek to pass on input cost increases to our customers, we may not be able to fully achieve this in all situations or at all times.

#### *Credit Risk*

Credit risk is the risk that counterparty will not meet its obligations under a financial instrument or customer contract, leading to a financial loss. Our Company is exposed to credit risk from its operating activities (primarily trade receivables) and from its financing activities, including deposits with banks and financial institutions, investment in mutual funds, other receivables and deposits, foreign exchange transactions and other financial instruments.

In relation to credit risk arising from financing activities, we monitor our credit spreads and financial strength on a regular basis, and based on our on-going assessment of counterparty risk, we adjust our exposure to various counterparties. For Fiscal 2019, 2020 and 2021 and for the nine months ended December 31, 2021, we made provision for doubtful debts amounting to ₹ 6.14 million, ₹ 8.49 million, ₹ 2.14 million and ₹ 1.25 million, respectively.

#### *Liquidity Risk*

Liquidity risk is the risk that the Company will encounter difficulty in meeting the obligations associated with its financial liabilities that are settled by delivering cash or another financial asset. Our Company's approach to managing liquidity is to ensure, as far as possible, that it will have sufficient liquidity to meet its liabilities when they are due, under both normal and stressed conditions, without incurring unacceptable losses or risking damage to our Company's reputation and on-going business.

We manage liquidity risk by maintaining adequate reserves, banking facilities and reserve borrowing facilities, by continuously monitoring forecast and actual cash flows, and by matching the maturity profiles of financial assets and liabilities.

For further information, see "**Restated Financial Statements – Annexure V – Note 41**" on page 325.

### **CHANGES IN ACCOUNTING POLICIES**

There have been no changes in our accounting policies during Fiscal 2019, 2020 and 2021, and in the nine months ended December 31, 2021.

### **UNUSUAL OR INFREQUENT EVENTS OR TRANSACTION**

Except as described in this Draft Red Herring Prospectus, to our knowledge, there have been no unusual or infrequent events or transactions that have in the past or may in the future affect our business operations or future financial performance.

### **SIGNIFICANT ECONOMIC CHANGES THAT MATERIALLY AFFECT OR ARE LIKELY TO AFFECT INCOME FROM CONTINUING OPERATIONS**

Our business has been subject, and we expect it to continue to be subject, to significant economic changes that materially affect or are likely to affect income from continuing operations identified above in “*Management’s Discussion and Analysis of Financial Condition and Results of Operations – Significant Factors Affecting our Results of Operations*” and the uncertainties described in “*Risk Factors*” on pages 358 and 27, respectively.

#### **KNOWN TRENDS OR UNCERTAINTIES**

Our business has been subject, and we expect it to continue to be subject, to significant economic changes arising from the trends identified above in “*Management’s Discussion and Analysis of Financial Condition and Results of Operations – Significant Factors Affecting our Results of Operations*” and the uncertainties described in “*Risk Factors*” on pages 358 and 27, respectively. To our knowledge, except as discussed in this Draft Red Herring Prospectus, there are no known trends or uncertainties that have or had or are expected to have a material adverse impact on revenues or income of our Company from continuing operations.

#### **FUTURE RELATIONSHIP BETWEEN COST AND INCOME**

Other than as described in “*Risk Factors*”, “*Our Business*” and “*Management’s Discussion and Analysis of Financial Condition and Results of Operations*” on pages 27, 149 and 355, respectively, to our knowledge there are no known factors that may adversely affect our business prospects, results of operations and financial condition.

#### **NEW PRODUCTS OR BUSINESS SEGMENTS**

Except as set out in this Draft Red Herring Prospectus, there are no new products or business segments in which we operate.

#### **COMPETITIVE CONDITIONS**

We operate in a competitive environment. See “*Our Business*”, “*Industry Overview*” and “*Risk Factors*” on pages 149, 111 and 27, respectively, for further details on competitive conditions that we face across our various business segments.

#### **EXTENT TO WHICH MATERIAL INCREASES IN NET SALES OR REVENUE ARE DUE TO INCREASED SALES VOLUME, INTRODUCTION OF NEW PRODUCTS OR SERVICES OR INCREASED SALES PRICES**

Changes in revenue in the last three Fiscals and nine months ended December 31, 2021 are as described in “*Management’s Discussion and Analysis of Financial Condition and Results of Operations – Fiscal 2021 compared to Fiscal 2020*”, “*Management’s Discussion and Analysis of Financial Condition and Results of Operations – Fiscal 2020 compared to Fiscal 2019*” and “*Management’s Discussion and Analysis of Financial Condition and Results of Operations – Nine months ended December 31, 2021*” above on pages 377, 380 and 382, respectively.

#### **SEGMENT REPORTING**

The Company operates primarily in the business of manufacturing of linkage parts and components for OHVs. Chief operating decision maker (“**CODM**”), evaluates our performance, based on the analysis of the various performance indicators of the company. The CODM has decided that there is no reportable segment for our Company. For further information, see “*Restated Financial Statements – Annexure V – Note 34*” on page 301.

#### **SIGNIFICANT DEVELOPMENTS AFTER DECEMBER 31, 2021 THAT MAY AFFECT OUR FUTURE RESULTS OF OPERATIONS**

Except as disclosed above and elsewhere in this Draft Red Herring Prospectus, to our knowledge no circumstances have arisen since December 31, 2021, that could materially and adversely affect or are likely to affect, our operations or profitability, or the value of our assets or our ability to pay our material liabilities within the next 12 months.

## SECTION VI – LEGAL AND OTHER INFORMATION

### OUTSTANDING LITIGATION AND OTHER MATERIAL DEVELOPMENTS

Except as stated in this section and in accordance with the materiality policy set out hereunder, as on the date of this Draft Red Herring Prospectus, there are no outstanding (i) criminal proceedings (ii) actions taken by regulatory or statutory authorities including notices issued by such authorities to the Relevant Parties (as defined hereinafter); (iii) claims related to any direct or indirect taxes in a consolidated manner; or (iv) other pending litigation as determined to be material by our Board as per the Materiality Policy, in each case involving our Company, our Subsidiaries, our Promoters or our Directors (“**Relevant Parties**”). Further, except as stated in this section, there are no disciplinary actions including penalties imposed by SEBI or stock exchanges against our Promoters in the last five Fiscals immediately preceding the date of this Draft Red Herring Prospectus including any outstanding action. As on the date of this Draft Red Herring Prospectus, our Company does not have any group company.

For the purposes of (iv) above, in terms of the Materiality Policy adopted by resolution of our board of directors dated March 22, 2022:

Following pending litigation proceedings (other than litigations mentioned in point (i) to (iii) above) involving the Relevant Parties shall be considered “material” for the purposes of disclosure in this Draft Red Herring Prospectus, where:

- a.) the claim / dispute amount, to the extent quantifiable exceeds 1% of the profit after tax of the Company, as per the restated consolidated financial statements of the Company included in this Draft Red Herring Prospectus for the last full Fiscal, being ₹ 9.23 million (“**Materiality Threshold**”);
- b.) where the monetary impact is not quantifiable or the amount involved may not exceed the materiality threshold set out under (a) above, but an outcome in any such litigation would materially and adversely affect the Company’s business, operations, cash flows, financial position or reputation of the Company and its subsidiaries, on a consolidated basis.

It is clarified that for the purposes of the above, pre-litigation notices received by the Relevant Parties from third parties (excluding those notices issued by statutory / regulatory / governmental / tax authorities) shall, in any event, not be considered as litigation until such time that Relevant Parties are impleaded as defendants in litigation proceedings before any judicial forum.

Further in terms of the Materiality Policy, creditors of our Company to whom amount due by our Company is equal to or in excess of 5% of the total consolidated trade payables of our Company as at the end of the most recent period included in the Restated Financial Statements, would be considered as material creditors. Accordingly, a creditor has been considered ‘material’ by our Company if the amount due to such creditor exceeds ₹ 43.04 million as on December 31, 2021 (“**Material Creditors**”).

All terms defined herein in a particular litigation disclosure pertain to that litigation only.

#### I. Litigation involving our Company

##### *Litigation against our Company*

##### A. Criminal proceedings

Nil

##### B. Actions taken by regulatory and statutory authorities

1. Our Company received a show cause notice dated October 18, 2021 from the Andhra Pradesh Pollution Control Board (“**AP PCB**”) pursuant to an inspection conducted on September 4, 2021. The show cause notice alleged non-compliance with the conditions prescribed under the CFO order dated January 9, 2018. The aforesaid show cause notice alleged, amongst other things, non-compliances in relation to maintaining provisions for port holes, power supply, non-installation of air pollution control equipment, mixing of process effluents with domestic waste water, pollution of rain water and separate energy meters. Subsequently, our Company in its reply, submitted a compliance report dated December 24, 2021 to the AP

PCB, stating that it has initiated necessary remedial action and further stating that it expected such actions to be completed within three months. Thereafter, our Company, pursuant to a letter dated March 21, 2022, requested the AP PCB to provide a further four months to complete such actions and submit the final compliance report, and such request was acknowledged by the AP PCB. The matter is currently pending.

*C. Civil proceedings*

Nil

*D. Tax proceedings*

We have disclosed claims relating to direct and indirect taxes involving our Company in a consolidated manner giving details of number of cases and total amount involved in such claims.

Particulars	Number of cases	Aggregate amount involved* (in ₹ million)
<b>Indirect Tax</b>		
Central Excise	6	0.21
VAT	8	2.33
GST	3	0.36
<b>Direct Tax</b>	11	99.32
<b>Total</b>	<b>28</b>	<b>102.23</b>

\* To the extent ascertainable.

**Details of direct tax proceedings involving our Company**

- Our Company is currently contesting an assessment order dated May 19, 2014 for the assessment year 2010-11, disputing the transfer pricing report, computation of our taxable income with respect to transfer pricing, interest received from GFPL, deposit of PF/ESI, as well as certain disallowances, amongst others. The total income tax demand amounted to ₹ 18.50 million. The matter is currently pending before the Income Tax Appellate Tribunal.
- Our Company is currently contesting an assessment order dated December 26, 2016 for the assessment year 2014-15, disputing the computation of our taxable income with respect to deposit of PF/ESI, loan received from GFPL, as well as certain disallowances, amongst others. The total income tax demand amounted to ₹28.37 million. The matter is currently pending before the Income Tax Appellate Tribunal.

**Litigation by our Company**

*A. Criminal Proceedings*

- Our Company filed a complaint dated February 28, 2018 (“**Complaint**”) under the provisions of the Indian Penal Code, 1860 and the Information Technology Act, 2000 with SHO, Police Station, Vasant Kunj, New Delhi against certain unknown hacker(s). Under the Complaint, the Company has alleged commission of, among other things, cheating, fraud and theft by such unknown hacker(s) against our Company and its customers by creating fake e-mail ids, false documents, impersonation, abatement, conspiracy, etc. The unknown hacker(s) had misguided the customers of our Company by requesting them to send outstanding monies to unauthorized bank accounts. Our Company has further alleged in the Complaint that the total amount involved in the fraud is ₹ 19.22 million. Our Company has not suffered any direct monetary loss due to the alleged fraud. The matter is pending.
- Our Company filed an FIR dated May 12, 2019 under Section 380 of the Indian Penal Code, 1860 with the SHO, Police Station, Rambilli, Visakhapatnam, Andhra Pradesh, against R. Rama Krishna for theft of spare parts weighing approximately 150 kilograms from our manufacturing facility located at Visakhapatnam, Andhra Pradesh. Since R. Rama Krishna was caught during the course of the theft, our Company has not suffered any monetary loss. The matter is pending.

*B. Civil proceedings*

- Our Company had placed an order with Mysore Kirloskar Limited (“**MKL**”) on July 24, 2000 for supply of 10 machines for a total consideration of ₹ 14.00 million which was accepted by MKL by its letters dated



August 2, 2000 and August 3, 2000 and acknowledged by MKL vide letter dated August 14, 2000. Our Company was informed that MKL had filed a reference under Section 15(1) of the Sick Industrial Companies (Special Provisions) Act, 1985 before the Board for Industrial and Financial Reconstruction (“BIFR”). On account of MKL’s failure to deliver the machines on the date of delivery, our Company issued a legal notice dated March 21, 2001 to MKL and its directors. Subsequently, the BIFR by its order dated October 31, 2002 directed MKL to be wound up and an Official Liquidator was appointed. Thereafter, our Company moved an application under Section 22(1) of the Sick Industrial Companies (Special Provisions) Act, 1985 before the BIFR seeking permission to file appropriate legal proceedings against MKL which however was not allowed. Thereafter, our Company filed a claim petition dated June 18, 2005 before the Official Liquidator, Bangalore claiming ₹ 67.89 million on account of the default and the Company has not received any communication from the Official Liquidator, Bangalore, yet.

## II. Litigation involving our Directors

### *Litigation against our Directors*

#### *Criminal proceedings*

Nil

#### *Actions by regulatory and statutory authorities involving our Directors*

Nil

#### *Civil proceedings*

Nil

#### *Tax proceedings*

Particulars	Number of cases	Aggregate amount involved* (in ₹ million)
<b>Direct Tax</b>		
<i>Gurdeep Soni</i>	3	1.82
<i>Shradha Suri</i>	2	Not ascertainable
<b>Total</b>	5	1.82

\* To the extent ascertainable

### *Litigation by our Directors*

Nil

## III. Litigation involving our Promoters

### *Litigation against our Promoters*

For details in relation to litigation against our Promoters, see “*Litigation involving our Directors – Litigation against our Directors – Tax Proceedings*” on page 391.

### *Disciplinary actions including penalty imposed by the SEBI or Stock Exchanges against our Promoter in the last five Fiscals*

As on the date of this Draft Red Herring Prospectus, no disciplinary action including penalty imposed by SEBI or stock exchanges has been initiated against our Promoters in the last five Fiscals including any outstanding action.

## IV. Litigation involving our Subsidiaries

### *Litigation against our Subsidiaries*

#### *Gripwel Fasteners Private Limited*

#### *Tax proceedings*

We have disclosed claims relating to direct and indirect taxes involving GFPL in a consolidated manner giving details of number of cases and total amount involved in such claims.

Particulars	Number of cases	Aggregate amount involved* (in ₹ million)
<b>Indirect Tax</b>		
VAT	1	0.18
GST	-	-
<b>Direct Tax</b>	1	0.02
<b>Total</b>	<b>2</b>	<b>0.20</b>

\* To the extent ascertainable.

## V. Outstanding dues to creditors

As of December 31, 2021, outstanding dues to Material Creditors, micro, small and medium enterprises and other creditors were as follows:

S. No.	Type of creditor	No. of creditors	Amount outstanding (₹ in million)
1.	Dues to micro, small and medium enterprises	355	309.95
2.	Dues to Material Creditors*	4	119.94
3.	Dues to other creditors	788	430.75
	<b>Total</b>	<b>1,147</b>	<b>860.64</b>

\* Amount due to Material Creditors includes 3 micro, small and medium enterprises having aggregate outstanding of ₹82.02 million.

The details pertaining to outstanding dues to Material Creditors, along with the names and amounts involved for each such Material Creditor, are available on the website of our Company at <https://www.unipartsgroup.com/material-creditors.asp?links=fi6>. It is clarified that such details available on our Company's website do not form a part of this Draft Red Herring Prospectus and should not be deemed to be incorporated by reference. Anyone placing reliance on any source of information including our Company's website, [www.unipartsgroup.com](http://www.unipartsgroup.com), would be doing so at their own risk.

## VI. Material Developments since the last balance sheet date

Except as disclosed in “*Management’s Discussion and Analysis of Financial Condition and Results of Operations*” on page 355, there have been no material developments, since the date of the last financial statements disclosed in this Draft Red Herring Prospectus, which materially and adversely affect, or are likely to affect our trading or profitability of our Company or the value of our assets or our ability to pay our liabilities within the next 12 months.

## GOVERNMENT AND OTHER APPROVALS

Except as disclosed herein and in “**Risk Factors**” on page 27, we have obtained all material consents, licenses, permissions and approvals from various governmental, statutory and regulatory authorities in India for our manufacturing facilities and warehouses, distribution centres and raw material storage space which are necessary for undertaking our business. The list below is indicative and does not include Offer and incorporation related approvals, which are set out in the sections entitled “**Other Regulatory and Statutory Disclosures**” and “**History and Certain Corporate Matters**” beginning on pages 395 and 180, respectively. In view of these approvals, our Company and its Subsidiaries can undertake their current business activities. Unless stated otherwise, we have obtained necessary approvals from the relevant government authorities with respect to our manufacturing facilities and warehouses and such approvals are valid as on the date of this Draft Red Herring Prospectus.

The material approvals, consents, licenses, registrations and permits obtained by our Company and its Material Subsidiaries, which enable it to undertake its current business activities, are set out below:

### 1. Material approvals in relation to our business operations

Material approvals in relation to our operational manufacturing facilities at (i) Noida (two units – one unit of our Company and the other of our Subsidiary, GFPL), Uttar Pradesh; (ii) Visakhapatnam, Andhra Pradesh; and (iii) Ludhiana (two units), Punjab:

- (a) Consent to operate issued by the respective pollution control board under the Water (Prevention and Control of Pollution) Act, 1974;
- (b) Consent to operate issued by the respective pollution control board under the Air (Prevention and Control of Pollution) Act, 1981;
- (c) Authorisation for generation, storage and disposal of hazardous wastes issued by the respective pollution control board under the Hazardous and other Wastes (Management and Transboundary Movement) Rules, 2016;
- (d) License to work a factory issued by the relevant State Government under the Factories Act, 1948;
- (e) Certificate of registration of establishments employing contract labour issued by the office of the registering officer, under the Contract Labour (Regulation and Abolition) Act, 1970;
- (f) No objection certificate issued by the fire department of the local municipal corporations of the respective states where our manufacturing facilities are located;
- (g) Registration of establishment for employees’ provident fund issued by the Employees’ Provident Fund Organisation under the Employees’ Provident Funds and Miscellaneous Provisions Act, 1952;
- (h) Registration of factory/establishment for employees’ insurance issued by the relevant regional office of the Employees State Insurance Corporation of different states in India under the Employees’ State Insurance Act, 1948;
- (i) Letter of approval for continued operations in Special Economic Zones issued by the Office of Development Commissioner, Ministry of Commerce and Industry for our manufacturing facility at Visakhapatnam and for one unit of our Subsidiary, GFPL, at Noida;
- (j) License to store propane gas in pressure vessels issued by the Petroleum and Explosives Safety Organisation for our manufacturing facility at Visakhapatnam;
- (k) License to install class B petroleum unit issued by the Petroleum and Explosives Safety Organisation for our manufacturing facility at Noida; and
- (l) License to store compressed gas in pressure vessels issued by the Petroleum and Explosives Safety Organisation for our manufacturing facility at Ludhiana.

Material approvals in relation to our (i) distribution centre at Noida, Uttar Pradesh; and (ii) raw material storage space at Noida, Uttar Pradesh:

- (a) Registration certificate of shops or commercial establishments issued by the labour department under the Uttar Pradesh Shops and Commercial Establishment Act, 1962;
- (b) No objection certificate issued by the fire department of the local municipal corporation of the respective states where the facility is located;

## **2. Tax related approvals of our Company**

- (a) Permanent account number AAACU0454D issued by the Income Tax Department under the Income Tax Act, 1961;
- (b) Tax deduction account number DELU01545F issued by the Income Tax Department under the Income Tax Act, 1961;
- (c) GST Registration number 09AAACU0454D1Z0 of our corporate office for GST payments under the Central Goods and Services Tax Act, 2017 and Uttar Pradesh Goods and Services Act, 2017; and
- (d) GST registration numbers of our manufacturing facilities, distribution centre and raw material storage space for GST payments under the central and state goods and services tax legislations.

## **3. Other material approvals**

- (a) Certificate of registration of establishment issued by the Department of Labour under the Delhi Shops and Establishment Act, 1954 for the registered office of our Company;
- (b) Certificate of importer-exporter code issued by the Ministry of Commerce and Industry for our Company and one of our Subsidiaries, GFPL; and
- (c) Registration cum membership certificate as a manufacturer exporter issued by the Engineering Export Promotion Council.





## **4. Material approvals in relation to our foreign Material Subsidiaries**

- (a) Business license issued by the Richmond County for our Subsidiary, UUL for right to operate its facilities;
- (b) VAT ID number DE815194395 issued by the Federal Central Tax Office for our Subsidiary, UIG for carrying on its international business;
- (c) Trade and business registration issued by the Commercial Registration Office Hennef (Sieg) for our Subsidiary, UIG for starting its business; and
- (d) Registration in the commercial register of Local Court Siegburg under HRB 11078.

## **5. Material approvals applied for but not received**

Our Company has applied for the no objection certificate for the use of ground water with the Ground Water Department, Uttar Pradesh for its manufacturing facility in Noida, Uttar Pradesh on March 14, 2022 and for GFPL's manufacturing facility in Noida, Uttar Pradesh on March 21, 2022. In addition, we have also applied for an Indian patent as well as an international patent, with respect to a component that we have developed i.e. the lower link hook.

## **6. Intellectual Property Rights**

We have six registered trademarks under class 12, of which we use “”, “” and “”, as a stamp on our products and “” as our corporate logo. All our trademarks are registered in the name of our Company, except for the wordmark “GRIPWEL” under class 6, 7 and 12 in Canada and class 7 and 12 in the European Union, which is registered under the name of one of our Subsidiaries, GFPL.

## OTHER REGULATORY AND STATUTORY DISCLOSURES

### Authority for the Offer

#### *Corporate Approvals*

- Our Board has authorised the Offer pursuant to its resolution dated March 30, 2022.
- Our Board has taken on record the consent of the Selling Shareholders to participate in the Offer for Sale pursuant to a resolution passed at its meeting held on April 25, 2022.
- Our Board has on April 25, 2022 approved this Draft Red Herring Prospectus for filing with SEBI and the Stock Exchanges.

#### *Approvals from the Selling Shareholders*

Each of the Selling Shareholders have, severally and not jointly, confirmed and authorised the transfer of its respective proportion of the Offered Shares pursuant to the Offer for Sale, as set out below:

S. No.	Name of the Selling Shareholder	Date of Consent Letter	Date of corporate authorisation/ board resolution	Maximum number of Offered Shares
<i>Promoter Group Selling Shareholders</i>				
1.	The Karan Soni 2018 CG-NG Nevada Trust	March 28, 2022	-	1,700,000
2.	The Meher Soni 2018 CG-NG Nevada Trust	March 28, 2022	-	1,700,000
3.	Pamela Soni	March 28, 2022	-	2,250,000
<i>Investor Selling Shareholders</i>				
4.	Ashoka Investment Holdings Limited	April 25, 2022	April 7, 2022	7,180,642
5.	Ambadevi Mauritius Holding Limited	April 25, 2022	April 7, 2022	2,154,192
<i>Individual Selling Shareholders</i>				
6.	Andrew Warren Code	March 10, 2022	-	177,378
7.	James Norman Hallene	March 10, 2022	-	177,378
8.	Kevin John Code	March 10, 2022	-	177,378
9.	Dennis Francis DeDecker	March 7, 2022	-	57,420
10.	Melvin Keith Gibbs	March 7, 2022	-	41,730
11.	Walter James Gruber	March 28, 2022	-	24,706
12.	Wendy Reichard Hammen	March 9, 2022	-	21,556
13.	Mark Louis Dawson	March 28, 2022	-	20,870
14.	Bradley Lorenz Miller	March 8, 2022	-	16,366
15.	Mary Louise Arp	March 28, 2022	-	10,440
16.	Diana Lynn Craig	March 8, 2022	-	8,340
17.	Marc Christopher Dorau	March 9, 2022	-	7,710
18.	Craig A Johnson	March 28, 2022	-	5,010
19.	Misty Marie Garcia	March 28, 2022	-	826
<b>Total</b>				<b>15,731,942</b>

Each of the Selling Shareholders, severally and not jointly, confirm that it is in compliance with Regulation 8 of the SEBI ICDR Regulations and it has held its respective portion of the Offered Shares for a period of at least one year prior to the date of filing of this Draft Red Herring Prospectus.

#### *In-principle Listing Approvals*

Our Company has received in-principle approvals from the BSE and NSE for the listing of our Equity Shares pursuant to its letter dated [●] and [●], respectively.

### **Prohibition by the SEBI, the RBI or Governmental Authorities**

Our Company, our Promoters, members of our Promoter Group, our Directors, persons in control of our Company are not prohibited from accessing or operating in the capital market or debarred from buying, selling or dealing in securities under any order or direction passed by SEBI or any securities market regulator in any other jurisdiction or any other authority/court.

None of the companies with which our Promoters and Directors are associated with as promoters, directors or persons in control have been debarred from accessing capital markets under any order or direction passed by SEBI or any other authorities.

Our Company, Promoters or Directors have not been declared as Wilful Defaulters by any bank or financial institution or consortium thereof in accordance with the guidelines on Wilful Defaulters issued by the RBI. Our Company or our Promoters, members of the Promoter Group or Directors are not declared as 'Fraudulent Borrowers' by the lending banks or financial institution or consortium, in terms of RBI master circular dated July 1, 2016.

None of our Promoters or Directors have been declared as fugitive economic offenders.

Each of the Selling Shareholders severally and not jointly confirms that it has not been prohibited from accessing the capital market or debarred from buying, selling, or dealing in securities under any order or direction passed by the SEBI or any securities market regulator in any other jurisdiction or any other authority/court.

### **Compliance with the Companies (Significant Beneficial Owners) Rules, 2018**

Our Company, our Promoters, members of our Promoter Group and each of the Selling Shareholders, severally and not jointly, confirm that they are in compliance with the Companies (Significant Beneficial Owners) Rules, 2018, as amended, to the extent applicable to them, as on the date of this Draft Red Herring Prospectus.

### **Directors associated with securities market**

None of our Directors are, in any manner, associated with the securities market. Further, there are no outstanding actions initiated by SEBI against any of our Directors, in the five years preceding the date of this Draft Red Herring Prospectus.

### **Eligibility for the Offer**

Our Company is eligible for the Offer in accordance with the eligibility criteria provided in Regulation 6(1) of the SEBI ICDR Regulations, and is in compliance with the conditions specified therein in the following manner:

- our Company has net tangible assets of at least ₹30.00 million, calculated on a restated and consolidated basis, in each of the preceding three full years (of 12 months each), of which not more than 50% are held as monetary assets;
- our Company has an average operating profit of at least ₹150.00 million, calculated on a restated and consolidated basis, during the preceding three years (of 12 months each), with operating profit in each of these preceding three years;
- our Company has a net worth of at least ₹10.00 million in each of the three preceding full years (of 12 months each), calculated on a restated and consolidated basis; and
- there has been no change of name of our Company at any time during the last one year immediately preceding the date of filing of this Draft Red Herring Prospectus.

Set forth below are our Company's operating profit, net tangible assets, monetary assets, monetary assets as a percentage of our net tangible assets and net worth, derived from our Restated Financial Statements included in this Draft Red Herring Prospectus.

*(₹ in million, unless otherwise stated)*

	<b>Financial year ended as on</b>		
	<b>March 31, 2021</b>	<b>March 31, 2020</b>	<b>March 31, 2019</b>
Restated net tangible assets <sup>(1)</sup>	4,715.46	3,725.86	3,277.55
Restated monetary assets <sup>(2)</sup>	108.31	169.70	151.01
% of monetary assets to net tangible assets	4.61	4.55	2.30
Restated operating profit <sup>(3)</sup>	821.20	607.50	1,078.40
Net worth <sup>(4)</sup>	5,593.81	4,641.65	4,219.81

*Notes:*

1. 'Net tangible assets' means the sum of all the assets of our Company excluding goodwill, intangible assets and right of use assets reduced by total liabilities excluding lease liability of the Company
2. 'Monetary assets' have been computed by taking the sum of all components of the cash and cash equivalents and bank balance other than cash and cash equivalent (other than balance with bank held as margin money and bank deposits with residual maturity period of more than 12 months) maintained by the Company.
3. 'Restated and consolidated operating profit' has been calculated as restated and consolidated net profit before tax excluding other income and finance cost each on a restated and consolidated basis.

4. For the purposes of the above, as per Regulation 2(1)(hh) of the SEBI ICDR Regulations as amended, "net worth" means the aggregate value of the paid-up share capital and all reserves created out of the profits and securities premium account and debit or credit balance of profit and loss account, after deducting the aggregate value of the accumulated losses, deferred expenditure and miscellaneous expenditure not written off, but does not include reserves created out of revaluation of assets, write-back of depreciation and amalgamation, each as applicable for the Company on a restated basis.

Our Company has operating profits and average operating profits in each of the Financial Years 2021, 2020 and 2019 in terms of our Restated Financial Statements.

Our Company confirms that it is in compliance with the conditions specified in Regulation 7(1) of the SEBI ICDR Regulations, to the extent applicable, and will ensure compliance with the conditions specified in Regulation 7(2) of the SEBI ICDR Regulations, to the extent applicable.

Further, in accordance with Regulation 49(1) of the SEBI ICDR Regulations, our Company shall ensure that the number of Allottees under the Offer shall be not less than 1,000, failing which, the entire application money will be refunded forthwith.

Further, our Company confirms that it is not ineligible to make the Offer in terms of Regulation 5 of the SEBI ICDR Regulations, to the extent applicable. Our Company is in compliance with the following conditions specified in Regulation 5 of the SEBI ICDR Regulations:

- (i) Our Company, the Selling Shareholders, our Promoters, the members of our Promoter Group, and our Directors are not debarred from accessing the capital market by SEBI;
- (ii) None of our Promoters or our Directors are promoters or directors of companies which are debarred from accessing the capital markets by SEBI;
- (iii) None of our Company, our Promoters or our Directors have been categorized as a Wilful Defaulter or a Fraudulent Borrower;
- (iv) None of our Promoters and our Directors are fugitive economic offenders (in accordance with Section 12 of the Fugitive Economic Offenders Act, 2018);
- (v) As on the date of this Draft Red Herring Prospectus, except for employee stock options granted pursuant to ESOP 2007, there are no outstanding warrants, options or rights to convert debentures, loans or other instruments convertible into, or which would entitle any person any option to receive Equity Shares.
- (vi) Our Company, along with the Registrar to the Company, has entered into tripartite agreements dated December 18, 2012 and August 25, 2014 with NSDL and CDSL, respectively, for dematerialization of the Equity Shares;
- (vii) The Equity Shares of our Company held by our Promoters are in dematerialised form; and
- (viii) The Equity Shares are fully paid-up and there are no partly paid-up Equity Shares as on the date of filing of this Draft Red Herring Prospectus.

#### **DISCLAIMER CLAUSE OF THE SEBI**

**IT IS TO BE DISTINCTLY UNDERSTOOD THAT SUBMISSION OF THIS DRAFT RED HERRING PROSPECTUS TO SEBI SHOULD NOT, IN ANY WAY, BE DEEMED OR CONSTRUED THAT THE SAME HAS BEEN CLEARED OR APPROVED BY SEBI. SEBI DOES NOT TAKE ANY RESPONSIBILITY EITHER FOR THE FINANCIAL SOUNDNESS OF ANY SCHEME OR THE PROJECT FOR WHICH THE OFFER IS PROPOSED TO BE MADE OR FOR THE CORRECTNESS OF THE STATEMENTS MADE OR OPINIONS EXPRESSED IN THIS DRAFT RED HERRING PROSPECTUS. THE BOOK RUNNING LEAD MANAGERS, BEING AXIS CAPITAL LIMITED, DAM CAPITAL ADVISORS LIMITED AND JM FINANCIAL LIMITED, HAVE CERTIFIED THAT THE DISCLOSURES MADE IN THIS DRAFT RED HERRING PROSPECTUS ARE GENERALLY ADEQUATE AND ARE IN CONFORMITY WITH THE SECURITIES AND EXCHANGE BOARD OF INDIA (ISSUE OF CAPITAL AND DISCLOSURE REQUIREMENTS) REGULATIONS, 2018, AS AMENDED. THIS REQUIREMENT IS TO FACILITATE INVESTORS TO TAKE AN INFORMED DECISION FOR MAKING AN INVESTMENT IN THE PROPOSED OFFER.**

**IT SHOULD ALSO BE CLEARLY UNDERSTOOD THAT WHILE THE COMPANY IS PRIMARILY RESPONSIBLE FOR THE CORRECTNESS, ADEQUACY AND DISCLOSURE OF ALL RELEVANT INFORMATION IN THE DRAFT RED HERRING PROSPECTUS, EACH OF THE SELLING SHAREHOLDERS, SEVERALLY AND NOT JOINTLY, WILL BE RESPONSIBLE ONLY FOR THE STATEMENTS SPECIFICALLY CONFIRMED OR UNDERTAKEN BY IT IN THIS DRAFT RED HERRING PROSPECTUS IN RELATION TO ITSELF FOR ITS RESPECTIVE PORTION OF OFFERED SHARES. THE BOOK RUNNING LEAD MANAGERS ARE EXPECTED TO EXERCISE DUE DILIGENCE TO ENSURE THAT THE COMPANY AND THE SELLING SHAREHOLDERS DISCHARGE THEIR RESPONSIBILITIES ADEQUATELY IN THIS BEHALF AND TOWARDS THIS PURPOSE, THE BOOK RUNNING LEAD MANAGERS, BEING AXIS CAPITAL LIMITED, DAM CAPITAL ADVISORS LIMITED AND JM FINANCIAL LIMITED HAVE FURNISHED TO SEBI, A DUE DILIGENCE CERTIFICATE DATED APRIL 25, 2022 IN THE FORMAT PRESCRIBED UNDER SCHEDULE V(A) OF THE SECURITIES AND EXCHANGE BOARD OF INDIA (ISSUE OF CAPITAL AND DISCLOSURE REQUIREMENTS) REGULATIONS, 2018, AS AMENDED.**

**THE FILING OF THE DRAFT RED HERRING PROSPECTUS DOES NOT, HOWEVER, ABSOLVE THE COMPANY FROM ANY LIABILITIES UNDER THE COMPANIES ACT, 2013, AS AMENDED OR FROM THE REQUIREMENT OF OBTAINING SUCH STATUTORY AND/OR OTHER CLEARANCES AS MAY BE REQUIRED FOR THE PURPOSE OF THE OFFER. SEBI FURTHER RESERVES THE RIGHT TO TAKE UP, AT ANY POINT OF TIME, WITH THE BOOK RUNNING LEAD MANAGERS, ANY IRREGULARITIES OR LAPSES IN THE DRAFT RED HERRING PROSPECTUS.**

#### **Disclaimer from our Company, our Directors, the Selling Shareholders and the BRLMs**

Our Company, our Directors, the Selling Shareholders and the BRLMs accept no responsibility for statements made otherwise than in this Draft Red Herring Prospectus or in the advertisements or any other material issued by or at our Company's instance and anyone placing reliance on any other source of information, including our Company's website, [www.unipartsgroup.com](http://www.unipartsgroup.com), or any of the Selling Shareholders, would be doing so at his or her own risk. It is clarified that none of the Selling Shareholders, nor any of its respective directors, partners, trustees, affiliates, associates and officers, accept and/or undertake any responsibility for any statements made or undertakings provided by any person other than those specifically made or undertaken by such Selling Shareholder in this Draft Red Herring Prospectus in relation to itself and its respective portion of the Offered Shares.

The BRLMs accept no responsibility, save to the limited extent as provided in the Offer Agreement and the Underwriting Agreement.

All information shall be made available by our Company, each of the Selling Shareholders (with respect to itself and its respective portion of the Offered Shares) and the BRLMs to the public and investors at large and no selective or additional information would be available for a section of the investors in any manner whatsoever, including at road show presentations, in research or sales reports, at Bidding centres or elsewhere.

Investors who Bid in the Offer will be required to confirm and will be deemed to have represented to our Company, the Selling Shareholders, Underwriters and their respective directors, partners, designated partners, trustees, officers, agents, affiliates, and representatives that they are eligible under all applicable laws, rules, regulations, guidelines and approvals to acquire the Equity Shares and will not issue, sell, pledge, or transfer the Equity Shares to any person who is not eligible under any applicable laws, rules, regulations, guidelines and approvals to acquire the Equity Shares. Our Company, the Selling Shareholders, Underwriters and their respective directors, partners, designated partners, trustees, officers, agents, affiliates, and representatives accept no responsibility or liability for advising any investor on whether such investor is eligible to acquire the Equity Shares.

The BRLMs and their respective associates and affiliates in their capacity as principals or agents may engage in transactions with, and perform services for, our Company, the Selling Shareholders and their respective affiliates or associates or third parties in the ordinary course of business and have engaged, or may in the future engage, in commercial banking and investment banking transactions with our Company, the Selling Shareholders and their respective affiliates or associates or third parties, for which they have received, and may in the future receive, compensation.

#### **Disclaimer in respect of Jurisdiction**



This Offer is being made in India to persons resident in India (including Indian nationals resident in India who are competent to contract under the Indian Contract Act, 1872, as amended, HUFs, companies, corporate bodies and societies registered under the applicable laws in India and authorised to invest in shares, domestic Mutual Funds registered with SEBI, Indian financial institutions, commercial banks, regional rural banks, co-operative banks (subject to permission from RBI), systemically important NBFCs or trusts under applicable trust law and who are authorised under their respective constitutions to hold and invest in shares, public financial institutions as specified in Section 2(72) of the Companies Act, 2013, multilateral and bilateral development financial institutions, state industrial development corporations, insurance companies registered with IRDAI, provident funds (subject to applicable law) and pension funds, National Investment Fund, insurance funds set up and managed by army, navy or air force of Union of India, insurance funds set up and managed by the Department of Posts, GoI, NBFC-SIs and permitted Non-Residents including FPIs and Eligible NRIs, AIFs, and other eligible foreign investors, if any, provided that they are eligible under all applicable laws and regulations to purchase the Equity Shares.

This Draft Red Herring Prospectus does not, however, constitute an offer to sell or an invitation to subscribe to Equity Shares offered hereby, in any jurisdiction to any person to whom it is unlawful to make an offer or invitation in such jurisdiction. Any person into whose possession this Draft Red Herring Prospectus comes is required to inform himself or herself about, and to observe, any such restrictions. This Draft Red Herring Prospectus does not constitute an invitation to subscribe to or purchase the Equity Shares offered in the Offer in any jurisdiction, including India. Invitations to subscribe to or purchase the Equity Shares offered in the Offer will be made only pursuant to the Red Herring Prospectus if the recipient is in India or the preliminary offering memorandum for the Offer, which comprises the Red Herring Prospectus and the preliminary international wrap for the Offer, if the recipient is outside India.

Any dispute arising out of this Offer will be subject to the jurisdiction of appropriate court(s) in New Delhi, India only.

No action has been, or will be taken to permit a public offering in any jurisdiction where action would be required for that purpose, except that this Draft Red Herring Prospectus has been filed with SEBI for its observations. Accordingly, the Equity Shares represented hereby may not be offered or sold, directly or indirectly, and this Draft Red Herring Prospectus may not be distributed, in any jurisdiction, except in accordance with the legal requirements applicable in such jurisdiction. Neither the delivery of this Draft Red Herring Prospectus, nor any offer or sale hereunder, shall, under any circumstances, create any implication that there has been no change in our affairs or in the affairs of any of the Selling Shareholders from the date hereof or that the information contained herein is correct as of any time subsequent to this date.

Bidders are advised to ensure that any Bid from them does not exceed the investment limits or maximum number of Equity Shares that can be held by them under applicable law.

**No person outside India is eligible to Bid for Equity Shares in the Offer unless that person has received the preliminary offering memorandum for the Offer, which contains the selling restrictions for the Offer outside India.**

#### **Eligibility and Transfer Restrictions**

**The Equity Shares offered in the Offer have not been and will not be registered under the U.S. Securities Act or any state securities laws in the United States, and may not be offered or sold within the United States, except pursuant to an exemption from, or in a transaction not subject to, the registration requirements of the U.S. Securities Act and applicable state securities laws in the United States. Accordingly, the Equity Shares are being offered and sold outside the United States in offshore transactions in compliance with Regulation S and the applicable laws of the jurisdiction where those offers and sales are made.**

**The Equity Shares have not been and will not be registered, listed or otherwise qualified in any other jurisdiction outside India and may not be offered or sold, and Bids may not be made by persons in any such jurisdiction, except in compliance with the applicable laws of such jurisdiction.**

Until the expiry of 40 days after the commencement of the Offer, an offer or sale of the Equity Shares within the United States by a dealer (whether or not it is participating in the Offer) may violate the registration requirements of the U.S. Securities Act unless made pursuant to available exemptions from the registration requirements of the U.S. Securities Act and in accordance with applicable state securities laws in the United States.

**Bidders are advised to ensure that any Bid from them does not exceed investment limits or the maximum number of Equity Shares that can be held by them under applicable law. Further, each Bidder where required must agree in the Allotment Advice that such Bidder will not sell or transfer any Equity Shares or any economic interest therein, including any off-shore derivative instruments, such as participatory notes, issued against the Equity Shares or any similar security, other than in accordance with applicable laws.**

#### **Disclaimer Clause of the BSE**

As required, a copy of this Draft Red Herring Prospectus shall be submitted to the BSE. The disclaimer clause as intimated by the BSE to us shall be included in the Red Herring Prospectus and the Prospectus prior to filing with the RoC.

#### **Disclaimer Clause of NSE**

As required, a copy of this Draft Red Herring Prospectus shall be submitted to NSE. The disclaimer clause as intimated by NSE to us shall be included in the Red Herring Prospectus and the Prospectus prior to filing with the RoC.

#### **Listing**

The Equity Shares issued through the Red Herring Prospectus and the Prospectus are proposed to be listed on the BSE and NSE. Applications will be made to the Stock Exchanges for obtaining permission to deal in and for an official quotation of the Equity Shares being issued and sold in the Offer and [●] is the Designated Stock Exchange, with which the Basis of Allotment will be finalised.

If the permission to deal in and for an official quotation of the Equity Shares is not granted by the Stock Exchanges, our Company shall forthwith repay, without interest, all monies received from the applicants in pursuance of the Red Herring Prospectus in accordance with applicable law.

Our Company shall ensure that all steps for the completion of the necessary formalities for listing and commencement of trading of Equity Shares at the Stock Exchanges are taken within six Working Days of the Bid/Offer Closing Date or such other period as may be prescribed by the SEBI. Each of the Selling Shareholders, severally and not jointly, confirms that it shall extend reasonable co-operation to the Company, as may be required in relation to their respective Offered Shares, in accordance with applicable law, to facilitate the process of listing the Equity Shares on the Stock Exchanges.

If our Company does not allot Equity Shares pursuant to the Offer within six Working Days from the Bid/Offer Closing Date or within such timeline as prescribed by the SEBI, it shall repay without interest all monies received from Bidders, failing which interest shall be due to be paid to the Bidders at the rate of 15% per annum for the delayed period. Each of the Selling Shareholders shall reimburse, severally and not jointly, and only to the extent of the respective portion of their Offered Shares, and as mutually agreed and in accordance with applicable law, any expenses and interest incurred by our Company on behalf of the Selling Shareholders for any delays in making refunds as required under the Companies Act and any other applicable law, provided that the Selling Shareholders shall not be responsible or liable for payment of any expenses or interest, unless such delay is solely and directly attributable to an act or omission of such Selling Shareholder in relation to itself or the respective portion of the Offered Shares.

#### **Consents**

Consents in writing of: (a) each of the Selling Shareholders, our Directors, our Company Secretary and Compliance Officer, the legal counsels, the bankers/ lenders to our Company, industry sources, the BRLMs and Registrar to the Offer have been obtained; and (b) the Syndicate Members, Bankers to the Offer/Escrow Bank, Public Offer Account Bank, Sponsor Bank(s) and Refund Bank(s) to act in their respective capacities, will be obtained and filed along with a copy of the Red Herring Prospectus with the RoC as required under the Companies Act. Further, such consents have not been withdrawn until the date of this Draft Red Herring Prospectus.

#### **Expert**

Except as stated below, our Company has not obtained any expert opinions:

Our Company has received written consent dated April 25, 2022 from the Statutory Auditors, to include their name as required under section 26(5) of the Companies Act, 2013 read with SEBI ICDR Regulations, in this Draft Red Herring Prospectus, and as an “expert” as defined under section 2(38) of the Companies Act, 2013 and in respect of (i) their examination report dated March 22, 2022 on our Restated Financial Statements; and (ii) their report dated April 25, 2022 on the Statement of Possible Special Tax Benefits in this Draft Red Herring Prospectus. However, the term “expert” shall not be construed to mean an “expert” as defined under the U.S. Securities Act.

Our Company has received written consent dated March 2, 2022, from the chartered engineer, namely D.V. Mehta, to include their name in this Draft Red Herring Prospectus and as an “expert” as defined under Section 2(38) of the Companies Act, 2013.

Our Company has received written consents dated (i) March 2, 2022, from an independent architect, namely ADI Designs Private Limited, (ii) March 7, 2022 from an independent architect, namely M/S Nirmaan Architects; (iii) March 3, 2022, from an independent architect, namely, Architects Bureau, to include their names in this Draft Red Herring Prospectus and as “experts” as defined under Section 2(38) of the Companies Act, 2013.

### **Particulars regarding public or rights issues during the last five years**

There have been no public issues or rights issues undertaken by our Company during the five years preceding the date of this Draft Red Herring Prospectus.

### **Commission or brokerage on previous issues in the last five years**

Since this is the initial public offering of the Equity Shares, no sum has been paid or has been payable as commission or brokerage for subscribing to or procuring or agreeing to procure public subscription for any of our Equity Shares in the five years preceding the date of this Draft Red Herring Prospectus.

### **Capital issues in the preceding three years by our Company, our listed group company, Subsidiaries and associates**

Our Company has not made any capital issuances during the three years preceding the date of this Draft Red Herring Prospectus. Our Subsidiaries have not made any capital issuances during the three years preceding the date of this Draft Red Herring Prospectus. Our Company does not have any associates or group company, as of the date of this Draft Red Herring Prospectus.

### **Performance vis-à-vis Objects – Public/ rights issue of our Company**

Our Company has not undertaken any public issues, including any rights issues to the public in the five years preceding the date of this Draft Red Herring Prospectus.

### **Performance vis-à-vis Objects –public/ rights issue of subsidiaries/ listed promoters**

As on the date of this Draft Red Herring Prospectus, our Company does not have any listed subsidiary or listed promoters.

### **Price Information of past issues handled by the BRLMs**

#### **Axis Capital Limited**

1. *Price information of past issues (during the current Financial Year and two Financial Years preceding the current Financial Year) handled by Axis Capital Limited.*

Sr. No.	Issue name	Issue size (₹ million)	Issue price (₹)	Listing date	Opening price on listing date (in ₹)	+/- % change in closing price, [+/- % change in closing benchmark]- 30th calendar days from listing	+/- % change in closing price, [+/- % change in closing benchmark]- 90th calendar days from listing	+/- % change in closing price, [+/- % change in closing benchmark]- 180th calendar days from listing
1	Vedant Fashions Limited <sup>(2)</sup>	31,491.95	866.00	16-Feb-22	935.00	+3.99%, [-0.20%]	-	-
2	CMS Info Systems Limited <sup>(1)</sup>	11,000.00	216.00	31-Dec-21	218.50	+21.99%, [-1.81%]	+25.35%, [+0.74%]	-
3	Supriya Lifescience Limited <sup>(1)</sup>	7,000.00	274.00	28-Dec-21	425.00	+78.61%, [-0.07%]	+72.12%, [-0.92%]	-
4	Medplus Health Services Limited <sup>*(1)</sup>	13,982.95	796.00	23-Dec-21	1,015.00	+53.22%, [+3.00%]	+23.06%, [+1.18%]	-

Sr. No.	Issue name	Issue size (₹ million)	Issue price (₹)	Listing date	Opening price on listing date (in ₹)	+/- % change in closing price, [+/- % change in closing benchmark]- 30th calendar days from listing	+/- % change in closing price, [+/- % change in closing benchmark]- 90th calendar days from listing	+/- % change in closing price, [+/- % change in closing benchmark]- 180th calendar days from listing
5	Metro Brands Limited <sup>(1)</sup>	13,675.05	500.00	22-Dec-21	436.00	+21.77%, [+4.45%]	+14.57%, [+0.64%]	-
6	C.E. Info Systems Limited <sup>(1)</sup>	10,396.06	1,033.00	21-Dec-21	1,581.00	+70.21%, [+6.71%]	+48.48%, [+2.74%]	-
7	Shriram Properties Limited <sup>(2)</sup>	6,000.00	118.00	20-Dec-21	90.00	-12.42%, [+9.02%]	-33.39%, [+4.05%]	-
8	Tega Industries Limited <sup>(2)</sup>	6,192.27	453.00	13-Dec-21	760.00	+30.70%, [+3.96%]	+1.02%, [-4.25%]	-
9	Star Health and Allied Insurance Company Limited <sup>(2)</sup>	60,186.84	900.00	10-Dec-21	845.00	-14.78%, [+1.72%]	-29.79%, [-6.66%]	-
10	Latent View Analytics Limited <sup>(1)</sup>	6,000.00	197.00	23-Nov-21	530.00	+153.58%, [-2.96%]	+142.08%, [-1.42%]	-

Source: [www.nseindia.com](http://www.nseindia.com) and [www.bseindia.com](http://www.bseindia.com)

<sup>(1)</sup>BSE as Designated Stock Exchange

<sup>(2)</sup>NSE as Designated Stock Exchange

\* Offer Price was ₹718.00 per equity share to Eligible Employees

§ Offer Price was ₹107.00 per equity share to Eligible Employees

^ Offer Price was ₹820.00 per equity share to Eligible Employees

® Offer Price was ₹178.00 per equity share to Eligible Employees

Notes:

- Issue Size derived from Prospectus/final post issue reports, as available.
- The CNX NIFTY or S&P BSE SENSEX is considered as the Benchmark Index as per the Designated Stock Exchange disclosed by the respective Issuer at the time of the issue, as applicable.
- Price on NSE or BSE is considered for all of the above calculations as per the Designated Stock Exchange disclosed by the respective Issuer at the time of the issue, as applicable.
- In case 30th/90th/180th day is not a trading day, closing price of the previous trading day has been considered.
- Since 30 calendar days, 90 calendar days and 180 calendar days, as applicable, from listing date has not elapsed for few of the above issues, data for same is not available.

## 2. Summary statement of price information of past issues (during the current Financial Year and two Financial Years preceding the current Financial Year) handled by Axis Capital Limited.

Financial Year	Total no. of IPOs	Total funds raised (₹ million)	Nos. of IPOs trading at discount on as on 30th calendar days from listing date			Nos. of IPOs trading at premium on as on 30th calendar days from listing date			Nos. of IPOs trading at discount as on 180th calendar days from listing date			Nos. of IPOs trading at premium as on 180th calendar days from listing date		
			Over 50%	Between 25%-50%	Less than 25%	Over 50%	Between 25%-50%	Less than 25%	Over 50%	Between 25%-50%	Less than 25%	Over 50%	Between 25%-50%	Less than 25%
2022-2023*	-	-	-	-	-	-	-	-	-	-	-	-	-	-
2021-2022	25	6,09,514.77	-	2	6	6	5	6	1	2	1	4	2	2
2020-2021	11	93,028.90	-	-	6	2	1	2	-	1	1	4	3	2

\* The information is as on the date of the document

The information for each of the financial years is based on issues listed during such financial year.

Note: Since 30 calendar days and 180 calendar days, as applicable, from listing date has not elapsed for few of the above issues, data for same is not available.

## **DAM Capital Advisors Limited**

### 1. Price information of past issues (during the current Financial Year and two Financial Years preceding the current Financial Year) handled by DAM Capital Advisors Limited.

Sr. No.	Issue name	Issue size (₹ million)	Issue price (₹)	Listing date	Opening price on listing date (in ₹)	+/- % change in closing price, [+/- % change in closing benchmark]- 30th calendar days from listing	+/- % change in closing price, [+/- % change in closing benchmark]- 90th calendar days from listing	+/- % change in closing price, [+/- % change in closing benchmark]- 180th calendar days from listing
1	CMS Info Systems Limited <sup>(2)</sup>	11,000.00	216.00	December 31, 2021	218.50	+21.99%, [-1.81%]	+25.35%, [+0.74%]	Not applicable
2	Metro Brands Limited <sup>(2)</sup>	13,675.05	500.00	December 22, 2021	436.00	+21.77%, [+4.45%]	+14.57%, [+0.64%]	Not applicable
3	C.E. Info Systems Limited <sup>(2)</sup>	10,396.06	1033.00	December 21, 2021	1,581.00	+70.21%, [+6.71%]	+48.48%, [+2.74%]	Not applicable
4	Star Health and Allied Insurance Company Limited <sup>(1)</sup>	60,186.84	900.00 <sup>®</sup>	December 10, 2021	845.00	-14.78%, [+1.72%]	-29.79%, [-6.66%]	Not applicable

Sr. No.	Issue name	Issue size (₹ million)	Issue price (₹)	Listing date	Opening price on listing date (in ₹)	+/- % change in closing price, [+/- % change in closing benchmark]- 30th calendar days from listing	+/- % change in closing price, [+/- % change in closing benchmark]- 90th calendar days from listing	+/- % change in closing price, [+/- % change in closing benchmark]- 180th calendar days from listing
5	Go Fashion (India) Limited <sup>(1)</sup>	10,136.09	690.00	November 30, 2021	1,310.00	+59.75%, [+1.36%]	+32.91%, [-1.91%]	Not applicable
6	Krsnaa Diagnostics Limited <sup>(1)</sup>	12,133.35	954.00*	August 16, 2021	1,005.55	-9.42%, [+4.93%]	-27.73%, [+9.30%]	-32.63%, [+4.90%]
7	Windlas Biotech Limited <sup>(2)</sup>	4,015.35	460.00	August 16, 2021	439.00	-18.02%, [+4.79%]	-34.42%, [+9.18%]	-37.01%, [+4.62%]
8	Glenmark Life Sciences Limited <sup>(2)</sup>	15,136.00	720.00	August 6, 2021	751.10	-6.38%, [+7.10%]	-12.94%, [+10.12%]	-20.67%, [+8.45%]
9	Laxmi Industries Limited <sup>(1)</sup>	6,000.00	130.00	March 25, 2021	155.50	+37.85%, [+0.11%]	+71.96%, [+10.11%]	+294.50%, [+21.45%]
10	Indian Finance Corporation Limited <sup>(1)</sup>	46,333.79	26.00	January 29, 2021	24.90	-5.19%, [+6.56%]	-18.65%, [+9.02%]	-11.15%, [+15.49%]

Source: [www.nseindia.com](http://www.nseindia.com) and [www.bseindia.com](http://www.bseindia.com)

\*A discount of ₹93 per equity share was provided to eligible employees bidding in the employee reservation portion.

@ A discount of ₹ 80 per equity share was provided to eligible employees bidding in the employee reservation portion.

(1) NSE was the designated stock exchange for the said issue.

(2) BSE was the designated stock exchange for the said issue.

**Notes:**

- Issue size derived from prospectus / basis of allotment advertisement, as applicable
- Price on NSE or BSE is considered for the above calculations as per the designated stock exchange disclosed by the respective issuer at the time of the issue, as applicable
- % of change in closing price on 30th / 90th / 180th calendar day from listing day is calculated vs issue price. % change in closing benchmark index is calculated based on closing index on listing day vs closing index on 30th / 90th / 180th calendar day from listing day.
- Wherever 30th / 90th / 180th calendar day from listing day is a holiday, the closing data of the previous trading day has been considered.
- The Nifty 50 or S&P BSE SENSEX index is considered as the benchmark index as per the designated stock exchange disclosed by the respective issuer at the time of the issue, as applicable
- Not applicable – Period not completed

**2. Summary statement of price information of past issues (during the current Financial Year and two Financial Years preceding the current Financial Year) handled by DAM Capital Advisors Limited.**

Financial Year	Total no. of IPOs	Total funds raised (₹ in millions)	Nos. of IPOs trading at discount on as on 30th calendar days from listing date			Nos. of IPOs trading at premium on as on 30th calendar days from listing date			Nos. of IPOs trading at discount as on 180th calendar days from listing date			Nos. of IPOs trading at premium as on 180th calendar days from listing date		
			Over 50%	Between 25%-50%	Less than 25%	Over 50%	Between 25%-50%	Less than 25%	Over 50%	Between 25%-50%	Less than 25%	Over 50%	Between 25%-50%	Less than 25%
2022-23	-	-	-	-	-	-	-	-	-	-	-	-	-	-
2021-22	8	136,678.74	-	-	4	2	-	2	-	2	1	-	-	-
2020-21	3	56,770.65	-	-	1	-	1	-	-	1	1	1	1	-

Source: [www.nseindia.com](http://www.nseindia.com) and [www.bseindia.com](http://www.bseindia.com)

**Notes:**

- The information is as on the date of this offer document
- The information for each of the financial years is based on issues listed during such financial year.
- Since 30 or 180 calendar days from listing date has not elapsed for few issues, hence data for same is not available.

**JM Financial Limited**

**1. Price information of past issues (during the current Financial Year and two Financial Years preceding the current Financial Year) handled by JM Financial Limited.**

Sr. No.	Issue name	Issue Size (₹ million)	Issue price (₹)	Listing Date	Opening price on Listing Date (in `)	+/- % change in closing price, [+/- % change in closing benchmark] - 30th calendar days from listing	+/- % change in closing price, [+/- % change in closing benchmark] - 90th calendar days from listing	+/- % change in closing price, [+/- % change in closing benchmark] - 180th calendar days from listing
1.	AGS Transact Technologies Limited <sup>#</sup>	6,800.00	175.00	January 31, 2022	176.00	-42.97% [-3.05%]	Not Applicable	Not Applicable
2.	CMS Info Systems Limited <sup>#</sup>	11,000.00	216.00	December 31, 2021	218.50	21.99% [-1.81%]	25.35% [0.74%]	Not Applicable
3.	Data Patterns (India) Limited <sup>#</sup>	5,882.24	585.00	December 24, 2021	856.05	29.70% [3.61%]	13.56% [1.42%]	Not Applicable
4.	C.E. Info Systems Limited <sup>#</sup>	10,396.06	1,033.00	December 21, 2021	1,394.55	70.21% [6.71%]	48.48% [2.74%]	Not Applicable

Sr. No.	Issue name	Issue Size (₹ million)	Issue price (₹)	Listing Date	Opening price on Listing Date (in `)	+/- % change in closing price, [+/- % change in closing benchmark] - 30 <sup>th</sup> calendar days from listing	+/- % change in closing price, [+/- % change in closing benchmark] - 90 <sup>th</sup> calendar days from listing	+/- % change in closing price, [+/- % change in closing benchmark] - 180 <sup>th</sup> calendar days from listing
5.	Tega Industries Limited*	6,192.27	453.00	December 13, 2021	760.00	30.70% [3.96%]	1.02% [-4.25%]	Not Applicable
6.	Go Fashion (India) Limited*	10,136.09	690.00	November 30, 2021	1,310.00	59.75% [1.36%]	32.91% [-1.91%]	Not Applicable
7.	Sapphire Foods India Limited	20,732.53	1,180.00	November 18, 2021	1,350.00	3.69% [-4.39%]	20.78% [-2.32%]	Not Applicable
8.	FSN – E-Commerce Ventures Limited* <sup>7</sup>	53,497.24	1,125.00	November 10, 2021	2018.00	92.31% [-2.78%]	68.46% [-4.46%]	Not Applicable
9.	Aditya Birla Sun Life AMC Limited*	27,682.56	712.00	October 11, 2021	715.00	-11.36% [0.55%]	-23.85% [-0.74%]	-25.65% [-0.90%]
10.	Krsnaa Diagnostics Limited* <sup>8</sup>	12,133.35	954.00	August 16, 2021	1,005.55	-9.42% [4.93%]	-27.73% [9.30%]	-32.63% [4.90%]

Source: [www.nseindia.com](http://www.nseindia.com) and [www.bseindia.com](http://www.bseindia.com)

<sup>#</sup> BSE as Designated Stock Exchange

\* NSE as Designated Stock Exchange

Notes:

- Opening price information as disclosed on the website of the Designated Stock Exchange.
- Change in closing price over the issue/offer price as disclosed on Designated Stock Exchange.
- For change in closing price over the closing price as on the listing date, the CNX NIFTY or S&P BSE SENSEX is considered as the Benchmark Index as per the Designated Stock Exchange disclosed by the respective Issuer at the time of the issue, as applicable.
- In case of reporting dates falling on a trading holiday, values for the trading day immediately preceding the trading holiday have been considered.
- 30<sup>th</sup> calendar day has been taken as listing date plus 29 calendar days; 90<sup>th</sup> calendar day has been taken as listing date plus 89 calendar days; 180<sup>th</sup> calendar day has been taken as listing date plus 179 calendar days.
- Restricted to last 10 issues.
- A discount of ₹ 100 per Equity Share was offered to Eligible Employees bidding in the Employee Reservation Portion.
- A discount of ₹ 93 per Equity Share was offered to Eligible Employees bidding in the Employee Reservation Portion.
- Not Applicable - Period not completed

## 2. Summary statement of price information of past issues (during the current Financial Year and two Financial Years preceding the current Financial Year) handled by JM Financial Limited.

Financial Year	Total no. of IPOs	Total funds raised (Millions)	Nos. of IPOs trading at discount on as on 30 <sup>th</sup> calendar days from listing date			Nos. of IPOs trading at premium on as on 30 <sup>th</sup> calendar days from listing date			Nos. of IPOs trading at discount as on 180 <sup>th</sup> calendar days from listing date			Nos. of IPOs trading at premium as on 180 <sup>th</sup> calendar days from listing date		
			Over 50%	Between 25% - 50%	Less than 25%	Over 50%	Between 25%- 50%	Less than 25%	Over 50%	Between 25%- 50%	Less than 25%	Over 50%	Between 25%- 50%	Less than 25%
2022-2023	-	-	-	-	-	-	-	-	-	-	-	-	-	-
2021-2022	17	2,89,814.06	-	1	2	5	5	4	-	2	-	4	1	2
2020-2021	8	62,102.09	-	-	3	2	1	2	-	-	-	5	2	1

## Track record of past issues handled by the BRLMs

For details regarding the track record of the BRLMs, as specified in circular reference CIR/MIRSD/1/2012 dated January 10, 2012 issued by SEBI, please see the websites of the BRLMs, as set forth in the table below:

Sr. No	Name of the BRLM	Website
1.	Axis Capital Limited	<a href="http://www.axiscapital.co.in">www.axiscapital.co.in</a>
2.	DAM Capital Advisors Limited	<a href="http://www.damcapital.in">www.damcapital.in</a>
3.	JM Financial Limited	<a href="http://www.jmfl.com">www.jmfl.com</a>

## Stock Market Data of the Equity Shares

This being an initial public offer of our Company, the Equity Shares are not listed on any stock exchange and accordingly, no stock market data is available for the Equity Shares.

## Mechanism for Redressal of Investor Grievances

SEBI, by way of its circular dated March 16, 2021 as amended by its circular dated April 20, 2022 (“**March 2021 Circular**”), has identified the need to put in place measures, in order to manage and handle investor issues arising out of the UPI Mechanism inter alia in relation to delay in receipt of mandates by Bidders for blocking of funds due to systemic issues faced by Designated Intermediaries/SCSBs and failure to unblock funds in cases of partial allotment/non allotment within prescribed timelines and procedures. Per the March 2021 Circular, SEBI has

prescribed certain mechanisms to ensure proper management of investor issues arising out of the UPI Mechanism, including: (i) identification of a nodal officer by SCSBs for the UPI Mechanism; (ii) delivery of SMS alerts by SCSBs for blocking and unblocking of UPI Mandate Requests; (iii) hosting of a web portal by the Sponsor Bank containing statistical details of mandate blocks/unblocks; (iv) limiting the facility of reinitiating UPI Bids to Syndicate Members to once per Bid; and (v) mandating SCSBs to ensure that the unblock process for non-allotted/partially allotted applications is completed by the closing hours of one Working Day subsequent to the finalisation of the Basis of Allotment.

The processing fees for applications made by UPI Bidders using the UPI Mechanism may be released to the remitter banks (SCSBs) only after such banks provide a written confirmation on compliance with SEBI circular no. SEBI/HO/CFD/DIL2/P/CIR/2021/570 dated June 2, 2021 read with SEBI circular no. SEBI/HO/CFD/DIL2/CIR/P/2021/2480/1/M dated March 16, 2021 and SEBI circular no. SEBI/HO/CFD/DIL2/CIR/P/2022/51 dated April 20, 2022.

Separately, pursuant to the March 2021 Circular, the following compensation mechanism shall be applicable for investor grievances in relation to Bids made through the UPI Mechanism, for which the relevant SCSBs shall be liable to compensate the investor:

Scenario	Compensation amount	Compensation period
Delayed unblock for cancelled / withdrawn / deleted applications	₹100 per day or 15% per annum of the Bid Amount, whichever is higher	From the date on which the request for cancellation / withdrawal / deletion is placed on the bidding platform of the Stock Exchanges till the date of actual unblock
Blocking of multiple amounts for the same Bid made through the UPI Mechanism	1. Instantly revoke the blocked funds other than the original application amount and 2. ₹100 per day or 15% per annum of the total cumulative blocked amount except the original Bid Amount, whichever is higher	From the date on which multiple amounts were blocked till the date of actual unblock
Blocking more amount than the Bid Amount	1. Instantly revoke the difference amount, i.e., the blocked amount less the Bid Amount and 2. ₹100 per day or 15% per annum of the difference amount, whichever is higher	From the date on which the funds to the excess of the Bid Amount were blocked till the date of actual unblock
Delayed unblock for non – Allotted/ partially Allotted applications	₹100 per day or 15% per annum of the Bid Amount, whichever is higher	From the Working Day subsequent to the finalisation of the Basis of Allotment till the date of actual unblock

Further, in the event there are any delays in resolving the investor grievance beyond the date of receipt of the complaint from the investor, for each day delayed, the post-Offer BRLM shall be liable to compensate the investor ₹100 per day or 15% per annum of the Bid Amount, whichever is higher. The compensation shall be payable for the period ranging from the day on which the investor grievance is received till the date of actual unblock.

The Registrar Agreement provides for retention of records with the Registrar to the Offer for a period of at least eight years from the date of listing and commencement of trading of the Equity Shares pursuant to the Offer, or such other period as may be prescribed under applicable law to enable the investors to approach the Registrar to the Offer for redressal of their grievances.

All grievances in relation to the Bidding process, other than of Anchor Investors, may be addressed to the Registrar to the Offer with a copy to the relevant Designated Intermediary to whom the Bid cum Application Form was submitted. The Bidder should give full details such as name of the sole or First Bidder, Bid cum Application Form number, Bidder DP ID, Client ID, UPI ID, PAN, date of the submission of Bid cum Application Form, address of the Bidder, number of the Equity Shares applied for and the name and address of the Designated Intermediary where the Bid cum Application Form was submitted by the Bidder. Further, the Bidder shall also enclose a copy of the Acknowledgment Slip duly received from the concerned Designated Intermediary in addition to the information mentioned hereinabove.

In terms of SEBI circular SEBI/HO/CFD/DIL2/CIR/P/2018/22 dated February 15, 2018 and the March 2021 Circular, any ASBA Bidder whose Bid has not been considered for Allotment, due to failure on the part of any

SCSB, shall have the option to seek redressal of the same by the concerned SCSB within three months of the date of listing of the Equity Shares. SCSBs are required to resolve these complaints within 15 days, failing which the concerned SCSB would have to pay interest at the rate of 15% per annum for any delay beyond this period of 15 days. Further, the investors shall be compensated by the SCSBs at the rate higher of ₹100 or 15% per annum of the application amount in the events of delayed or withdrawal of applications, blocking of multiple amounts for the same UPI application, blocking of more amount than the application amount, delayed unblocking of amounts for the stipulated period. In an event there is a delay in redressal of the investor grievance, the BRLMs shall compensate the investors at the rate higher of ₹100 or 15% per annum of the application amount. For helpline details of the Book Running Lead Managers pursuant to March 2021 Circular, see “**General Information – Book Running Lead Managers**” on page 79.

Further, the Bidder shall also enclose a copy of the Acknowledgment Slip duly received from the concerned Designated Intermediary in addition to the information mentioned hereinabove.

Anchor Investors are required to address all grievances in relation to the Offer to the BRLMs.

The Registrar to the Offer shall obtain the required information from the SCSBs for addressing any clarifications or grievances of ASBA Bidders.

Our Company, the BRLMs and the Registrar to the Offer accept no responsibility for errors, omissions, commission or any acts of SCSBs including any defaults in complying with their obligations under applicable SEBI ICDR Regulations.

Investors can contact the Compliance Officer, the BRLMs or the Registrar to the Offer in case of any pre-Offer or post-Offer related problems such as non-receipt of letters of Allotment, non-credit of allotted Equity Shares in the respective beneficiary account, non-receipt of refund intimations or non-receipt of funds by electronic mode.

#### **Disposal of Investor Grievances by our Company**

Our Company estimates that the average time required by our Company or the Registrar to the Offer or the SCSB in case of ASBA Bidders, for the redressal of routine investor grievances shall be seven Working Days from the date of receipt of the complaint. In case of non-routine complaints and complaints where external agencies are involved, our Company will seek to redress these complaints as expeditiously as possible.

Our Company shall obtain authentication on the SEBI SCORES platform and shall comply with the SEBI circulars in relation to redressal of investor grievances through SCORES.

Our Company, the Selling Shareholders, the Book Running Lead Managers and the Registrar to the Offer accept no responsibility for errors, omissions, commission of any acts of the Designated Intermediaries, including any defaults in complying with its obligations under the SEBI ICDR Regulations.

Our Company has constituted a Stakeholders’ Relationship Committee which is responsible for redressal of grievances of the security holders of our Company. For details, see “**Our Management**” on page 189.

Our Company has appointed Jatin Mahajan as the Company Secretary and Compliance Officer who may be contacted in case of any pre-Offer or post-Offer related grievances. Their contact details are as follows:

1<sup>st</sup> Floor, B208  
A1 & A2, Phase-II  
Noida 201 305  
Uttar Pradesh, India  
**Tel:** +91 120 458 1400  
**E-mail:** compliance.officer@unipartsgroup.com

Each of the Selling Shareholders have severally and not jointly authorised the Company to take all actions in respect of the Offer for Sale; and on its behalf in accordance with Section 28 of the Companies Act, 2013.

Our Company has not received any investor complaint during the three years preceding the date of this Draft Red Herring Prospectus. Further, no investor complaint in relation to our Company is pending as on the date of this Draft Red Herring Prospectus.

#### **Exemption from complying with any provisions of securities laws, if any, granted by SEBI**



Our Company, pursuant to a letter dated April 25, 2022 has sought an exemption from the inclusion of Navjit Bindra, sister of the spouse of our Promoter Paramjit Singh Soni, from inclusion in the “Promoter Group” on account of not receiving any information from Navjit Bindra and entities she may be interested in for inclusion in this Draft Red Herring Prospectus.

## SECTION VII – OFFER RELATED INFORMATION

### TERMS OF THE OFFER

The Equity Shares being offered and Allotted in the Offer will be subject to the provisions of the Companies Act, the SEBI ICDR Regulations, the SCRA, the SCRR, the Memorandum of Association, the Articles of Association, the SEBI Listing Regulations, the terms of this Draft Red Herring Prospectus, the Red Herring Prospectus and the Prospectus, the Bid cum Application Form, the Revision Form, the abridged prospectus and other terms and conditions as may be incorporated in the CAN (for Anchor Investors), Allotment Advice and other documents and certificates that may be executed in respect of the Offer. The Equity Shares shall also be subject to all applicable laws, guidelines, rules, notifications and regulations relating to the issue of capital and listing and trading of securities, issued from time to time, by SEBI, the Government of India, the Stock Exchange, the RoC, the RBI and/or other authorities, as in force on the date of the Offer and to the extent applicable or such other conditions as maybe prescribed by SEBI, the Government of India, the Stock Exchange, the RoC, the RBI and/or other authorities while granting approval for the Offer.

#### Ranking of Equity Shares

The Equity Shares being offered and transferred pursuant to the Offer shall be subject to the provisions of the Companies Act, SEBI Listing Regulations, SEBI ICDR Regulations, SCRA read with SCRR, the Memorandum of Association and the Articles of Association and will rank *pari passu* in all respects with the existing Equity Shares of our Company, including in respect of rights to receive dividends and other corporate benefits, if any, declared by our Company after the date of transfer in accordance with applicable law. For more information, see “*Main Provisions of the Articles of Association*” on page 436.

#### Mode of Payment of Dividend

Our Company will pay dividends, if declared, to the Shareholders, as per the provisions of the Companies Act 2013, the SEBI Listing Regulations, the Memorandum of Association and the Articles of Association, and any guidelines or directives that may be issued by the Government of India in this respect. Any dividends declared, after the date of Allotment (pursuant to the transfer of Equity Shares in the Offer for Sale) in this Offer, will be payable to the Allottees who have been Allotted Equity Shares in the Offer, for the entire year, in accordance with applicable laws. For more information, see “*Dividend Policy*” and “*Main Provisions of the Articles of Association*” on pages 211 and 436, respectively.

#### Face Value, Offer Price, Floor Price and Price Band

The face value of each Equity Share is ₹10 and the Offer Price at the lower end of the Price Band is ₹[●] per Equity Share and at the higher end of the Price Band is ₹[●] per Equity Share. The Anchor Investor Offer Price is ₹[●] per Equity Share.

The Offer Price, the Price Band, the minimum Bid Lot will be decided by our Company and the Investor Selling Shareholders in consultation with the BRLMs, after the Bid/ Offer Closing Date, on the basis of assessment of market demand for the Equity Shares offered by way of Book Building Process., and published by our Company in all editions of [●] (a widely circulated English national daily newspaper) and all editions of [●] (a widely circulated Hindi national daily newspaper, Hindi also being the regional language of New Delhi, where our Registered Office is located) at least two Working Days prior to the Bid/Offer Opening Date, in, and shall be made available to the Stock Exchanges for the purpose of uploading the same on their websites. The Price Band, along with the relevant financial ratios calculated at the Floor Price and at the Cap Price shall be pre-filled in the Bid-cum-Application Forms available at the respective websites of the Stock Exchanges.

At any given point in time there will be only one denomination for the Equity Shares.

#### Compliance with disclosure and accounting norms

Our Company shall comply with all disclosure and accounting norms as specified by SEBI from time to time.

#### The Offer

The Offer comprises of an Offer for Sale by the Selling Shareholders. Expenses for the Offer shall be shared amongst our Company and each of the Selling Shareholders in the manner specified in “*Objects of the Offer – Offer related expenses*” on page 103.

## **Rights of the Equity Shareholder**

Subject to applicable laws, rules, regulations and guidelines and the Articles of Association, the Equity Shareholders will have the following rights:

- Right to receive dividends, if declared;
- Right to attend general meetings and exercise voting powers, unless prohibited by law;
- Right to vote on a poll either in person or by proxy and e-voting;
- Right to receive offers for rights shares and be allotted bonus shares, if announced;
- Right to receive any surplus on liquidation subject to any statutory and preferential claims being satisfied;
- Right of free transferability of their Equity Shares, subject to applicable foreign exchange regulations and other applicable law; and
- Such other rights as may be available to a shareholder of a listed public company under the Companies Act, the terms of the SEBI Listing Regulations and our Memorandum of Association and Articles of Association.

For a detailed description of the main provisions of our Articles of Association relating to voting rights, dividend, forfeiture, lien, transfer, transmission, consolidation and splitting, see “*Main Provisions of the Articles of Association*” on page 436.

## **Allotment only in Dematerialised Form**

Pursuant to Section 29 of the Companies Act, 2013 the Equity Shares shall be allotted only in dematerialised form. As per the SEBI ICDR Regulations, the trading of the Equity Shares shall only be in dematerialised form on the Stock Exchanges.

In this context, two agreements have been signed amongst our Company, the respective Depositories and the Registrar to the Offer:

- Tripartite Agreement dated December 18, 2012 among NSDL, our Company and the Registrar to the Offer; and
- Tripartite Agreement dated August 25, 2014 among CDSL, our Company and Registrar to the Offer.

## **Market Lot and Trading Lot**

Since trading of the Equity Shares is in dematerialised form, the tradable lot is one Equity Share. Allotment in the Offer will be only in electronic form in multiples of one Equity Share, subject to a minimum Allotment of [●] Equity Shares. For the method of Basis of Allotment, see “*Offer Procedure*” on page 417.

## **Jurisdiction**

Exclusive jurisdiction for the purpose of the Offer is with the competent courts/authorities in New Delhi, India.

The Equity Shares offered in the Offer have not been and will not be registered under the U.S. Securities Act or any state securities laws in the United States, and may not be offered or sold within the United States, except pursuant to an exemption from, or in a transaction not subject to, the registration requirements of the U.S. Securities Act and applicable state securities laws in the United States. Accordingly, the Equity Shares are being offered and sold outside the United States in offshore transactions in compliance with Regulation S and the applicable laws of the jurisdiction where those offers and sales are made. The Equity Shares have not been and will not be registered, listed or otherwise qualified in any other jurisdiction outside India and may not be offered or sold, and Bids may not be made by persons in any such jurisdiction, except in compliance with the applicable laws of such jurisdiction.

## **Joint Holders**

Subject to the provisions of the Articles of Association, where two or more persons are registered as the holders of the Equity Shares, they will be deemed to hold such Equity Shares as joint tenants with benefits of survivorship.

## **Nomination Facility**

In accordance with Section 72 of the Companies Act 2013, read with Companies (Share Capital and Debentures)

Rules, 2014, as amended, the sole Bidder, or the first Bidder along with other joint Bidders, may nominate any one person in whom, in the event of the death of sole Bidder or in case of joint Bidders, death of all the Bidders, as the case may be, the Equity Shares Allotted, if any, shall vest. A person, being a nominee, entitled to the Equity Shares by reason of the death of the original holder(s), shall be entitled to the same advantages to which he or she would be entitled if he or she were the registered holder of the Equity Share(s). Where the nominee is a minor, the holder(s) may make a nomination to appoint, in the prescribed manner, any person to become entitled to Equity Share(s) in the event of his or her death during the minority. A nomination shall stand rescinded upon a sale, transfer or alienation of Equity Share(s) by the person nominating. A buyer will be entitled to make a fresh nomination in the manner prescribed. Fresh nomination can be made only on the prescribed form available on request at our Registered Office or to the registrar and transfer agents of our Company.

Further, any person who becomes a nominee by virtue of Section 72 of the Companies Act 2013, as amended, will, on the production of such evidence as may be required by our Board, elect either:

- to register himself or herself as holder of Equity Shares; or
- to make such transfer of the Equity Shares, as the deceased holder could have made.

Further, our Board may at any time give notice requiring any nominee to choose either to be registered himself or herself or to transfer the Equity Shares, and if the notice is not complied with within a period of 90 days, our Board may thereafter withhold payment of all dividend, interests, bonuses or other monies payable in respect of the Equity Shares, until the requirements of the notice have been complied with.

Since the Allotment of Equity Shares in the Offer will be made only in dematerialised form, there is no need to make a separate nomination with our Company. Nominations registered with the respective Depository Participant of the Bidder will prevail. If Bidders want to change their nomination, they are advised to inform their respective Depository Participants.

#### **Bid/Offer Period**

<b>BID/OFFER OPENS ON*</b>	[●]
<b>BID/OFFER CLOSES ON**</b>	[●]

\* Our Company and the Investor Selling Shareholders may, in consultation with the BRLMs, consider participation by Anchor Investors. The Anchor Investor Bid/Offer Period shall be one Working Day prior to the Bid/Offer Opening Date.

\*\* Our Company and the Investor Selling Shareholders may, in consultation with the BRLMs, consider closing the Bid/Offer Period for QIBs one Working Day prior to the Bid/Offer Closing Date in accordance with the SEBI ICDR Regulations.

An indicative timetable in respect of the Offer is set out below:

<b>BID/OFFER CLOSING DATE</b>	[●]
<b>FINALISATION OF BASIS OF ALLOTMENT WITH THE DESIGNATED STOCK EXCHANGE</b>	On or about [●]
<b>INITIATION OF REFUNDS FOR ANCHOR INVESTORS/ UNBLOCKING OF FUNDS FROM ASBA ACCOUNT*</b>	On or about [●]
<b>CREDIT OF EQUITY SHARES TO DEPOSITORY ACCOUNTS</b>	On or about [●]
<b>COMMENCEMENT OF TRADING OF THE EQUITY SHARES ON THE STOCK EXCHANGE</b>	On or about [●]

\* In case of any delay in unblocking of amounts in the ASBA Accounts (including amounts blocked through the UPI Mechanism) exceeding four Working Days from the Bid/Offer Closing Date for cancelled/ withdrawn/ deleted ASBA Forms, the Bidder shall be compensated at a uniform rate of ₹100 per day or 15% per annum of the Bid Amount, whichever is higher from the date on which the request for cancellation/ withdrawal/ deletion is placed in the Stock Exchanges bidding platform until the date on which the amounts are unblocked (ii) any blocking of multiple amounts for the same ASBA Form (for amounts blocked through the UPI Mechanism), the Bidder shall be compensated at a uniform rate ₹100 per day or 15% per annum of the total cumulative blocked amount except the original application amount, whichever is higher from the date on which such multiple amounts were blocked till the date of actual unblock; (iii) any blocking of amounts more than the Bid Amount, the Bidder shall be compensated at a uniform rate of ₹100 per day or 15% per annum of the difference in amount, whichever is higher from the date on which such excess amounts were blocked till the date of actual unblock; (iv) any delay in unblocking of non-allotted/ partially allotted Bids, exceeding four Working Days from the Bid/Offer Closing Date, the Bidder shall be compensated at a uniform rate of ₹100 per day or 15% per annum of the Bid Amount, whichever is higher for the entire duration of delay exceeding four Working Days from the Bid/Offer Closing Date by the SCSB responsible for causing such delay in unblocking. The BRLMs shall, in their sole discretion, identify and fix the liability on such intermediary or entity responsible for such delay in unblocking. The Bidder shall be compensated in the manner specified in the SEBI circular no. SEBI/HO/CFD/DIL1/CIR/P/2021/47 dated March 31, 2021 and SEBI circular no.

*SEBI/HO/CFD/DIL2/CIR/P/2021/2480/1/M dated March 16, 2021, as amended pursuant to SEBI circular no. SEBI/HO/CFD/DIL2/P/CIR/2021/570 dated June 2, 2021 and SEBI circular no. SEBI/HO/CFD/DIL2/CIR/P/2022/51 dated April 20, 2022, which for the avoidance of doubt, shall be deemed to be incorporated in the deemed agreement of the Company with the SCSBs, to the extent applicable.*

*The processing fees for applications made by UPI Bidders using the UPI Mechanism may be released to the remitter banks (SCSBs) only after such banks provide a written confirmation on compliance with SEBI circular no. SEBI/HO/CFD/DIL2/P/CIR/2021/570 dated June 2, 2021 read with SEBI circular no. SEBI/HO/CFD/DIL2/CIR/P/2021/2480/1/M dated March 16, 2021 and SEBI circular no. SEBI/HO/CFD/DIL2/CIR/P/2022/51 dated April 20, 2022.*

**The above timetable, other than the Bid/Offer Closing Date, is indicative and does not constitute any obligation on our Company or any of the Selling Shareholders or the BRLMs.**

**Whilst our Company shall ensure that all steps for the completion of the necessary formalities for the listing and the commencement of trading of the Equity Shares on the Stock Exchanges are taken within six Working Days of the Bid/Offer Closing Date or such period as may be prescribed, with reasonable support and co-operation of each of the Selling Shareholders, as may be required in respect of its respective portion of the Offered Shares, the timetable may change due to various factors, such as extension of the Bid/Offer Period by our Company and the Investor Selling Shareholders, in consultation with the BRLMs, revision of the Price Band or any delay in receiving the final listing and trading approval from the Stock Exchanges. Our Company shall within four days from the closure of the Offer, refund the subscription amount received in case of non-receipt of minimum subscription or in case our Company fails to obtain listing or trading permission from the Stock Exchanges for the Equity Shares. The commencement of trading of the Equity Shares will be entirely at the discretion of the Stock Exchanges and in accordance with the applicable laws. Each of the Selling Shareholders, severally and not jointly, confirms that it shall extend reasonable co-operation to the Company, as may be required in relation to their respective Offered Shares, in accordance with applicable law, to facilitate the process of listing the Equity Shares on the Stock Exchanges.**

**In terms of the UPI Circulars, in relation to the Offer, the BRLMs will be required to submit reports of compliance with timelines and activities prescribed by SEBI in connection with the allotment and listing procedure within six Working Days from the Bid/Offer Closing Date, identifying non-adherence to timelines and processes and an analysis of entities responsible for the delay and the reasons associated with it.**

**SEBI is in the process of streamlining and reducing the post issue timeline for IPOs. Any circulars or notifications from SEBI after the date of this Draft Red Herring Prospectus may result in changes to the above mentioned timelines. Further, the offer procedure is subject to change basis any revised SEBI circulars to this effect.**

**Submission of Bids (other than Bids from Anchor Investors):**

<b>Bid/Offer Period (except the Bid/Offer Closing Date)</b>	
Submission and Revision in Bids	Only between 10.00 a.m. and 5.00 p.m. (Indian Standard Time (“IST”))
<b>Bid/Offer Closing Date</b>	
Submission and Revision in Bids	Only between 10.00 a.m. and 3.00 p.m. IST

**On the Bid/Offer Closing Date, the Bids shall be uploaded until:**

- (i) 4.00 p.m. IST in case of Bids by QIBs and Non-Institutional Investors, and
- (ii) until 5.00 p.m. IST or such extended time as permitted by the Stock Exchanges, in case of Bids by Retail Individual Investors.

On Bid/Offer Closing Date, extension of time will be granted by Stock Exchanges only for uploading Bids received by Retail Individual Investors after taking into account the total number of Bids received up to closure of timings for acceptance of Bid cum Application Forms as stated herein and as reported by the BRLMs to the Stock Exchanges.

The Registrar to the Offer shall submit the details of cancelled/ withdrawn/ deleted applications to the SCSBs on a daily basis within 60 minutes of the bid closure time from the Bid/ Offer Opening Date till the Bid/Offer Closing Date by obtaining such information from the Stock Exchanges. The SCSBs shall unblock such applications by the closing hours of the Working Day.

To avoid duplication, the facility of re-initiation provided to Syndicate Members shall preferably be allowed only once per bid/batch and as deemed fit by the Stock Exchanges, after closure of the time for uploading Bids.

**It is clarified that Bids not uploaded on the electronic bidding system or in respect of which the full Bid Amount is not blocked by SCSBs, or not blocked under the UPI Mechanism in the relevant ASBA Account, as the case may be, would be rejected. The Registrar to the Offer shall submit the details of cancelled/withdrawn/deleted applications to the SCSBs on daily basis within 60 minutes of the Bid closure time from the Bid/ Offer Opening Date till the Bid/ Offer Closing Date by obtaining the same from the Stock Exchanges. The SCSBs shall unblock such applications by the closing hours of the Working Day.**

Due to limitation of time available for uploading the Bids on the Bid/Offer Closing Date, Bidders are advised to submit their Bids one day prior to the Bid/Offer Closing Date. Any time mentioned in this Draft Red Herring Prospectus is IST. Bidders are cautioned that, in the event a large number of Bids are received on the Bid/Offer Closing Date, some Bids may not get uploaded due to lack of sufficient time. Such Bids that cannot be uploaded will not be considered for allocation under the Offer. Bids will be accepted on the Stock Exchange platform only during Working Days, during the Bid/ Offer Period and revisions shall not be accepted on Saturdays and public holidays. It is clarified that Bids not uploaded on the electronic bidding system or in respect of which the full Bid Amount is not blocked by SCSBs or not blocked under the UPI Mechanism in the relevant ASBA Account, as the case may be, would be rejected.

Our Company and the Investor Selling Shareholders in consultation with the BRLMs, reserve the right to revise the Price Band during the Bid/Offer Period in accordance with the SEBI ICDR Regulations. The revision in the Price Band shall not exceed 20% on either side, i.e. the Floor Price may move up or down to the extent of 20% of the Floor Price and the Cap Price will be revised accordingly, but the Floor Price shall not be less than the face value of the Equity Shares. In all circumstances, the Cap Price shall be at least 105% of the Floor Price and less than or equal to 120% of the Floor Price.

**In case of any revision to the Price Band, the Bid/Offer Period will be extended by at least three additional Working Days following such revision of the Price Band, subject to the Bid/Offer Period not exceeding 10 Working Days. In cases of force majeure, banking strike or similar circumstances, our Company and the Investor Selling Shareholders, in consultation with the Book Running Lead Managers may, for reasons to be recorded in writing, extend the Bid/Offer Period for a minimum of three Working Days, subject to the Bid/Offer Period not exceeding 10 Working Days. Any revision in the Price Band and the revised Bid/Offer Period, if applicable, will be widely disseminated by notification to the Stock Exchanges, by issuing a public notice, and also by indicating the change on the respective websites of the BRLMs and at the terminals of the Syndicate Members and by intimation to the Designated Intermediaries and the Sponsor Bank, as applicable. In case of revision of price band, the Bid lot shall remain the same.**

In case of discrepancy in data entered in the electronic book vis-vis data contained in the Bid cum Application Form for a particular Bidder, the details as per the Bid file received from the Stock Exchanges shall be taken as the final data for the purpose of Allotment.

### **Minimum Subscription**

The requirement of minimum subscription is not applicable to the Offer in accordance with the SEBI ICDR Regulations. However, if our Company does not make the minimum Allotment as specified under terms of the Rule 19(2)(b) of the SCRR, including devolvement of Underwriters, if any, the Selling Shareholders, to the extent applicable, or fails to obtain listing or trading permission from the Stock Exchanges for the Equity Shares, our Company shall within four days from the closure of the Offer, refund the entire subscription amount received. If there is a delay beyond four days, interest at the rate of 15% per annum shall be paid by our Company and each of our Directors, in accordance SEBI circular bearing no. SEBI/HO/CFD/DIL2/CIR/P/2021/2480/1/M dated March 16, 2021, including the SEBI circular bearing no. SEBI/HO/CFD/DIL1/CIR/P/2021/47 dated March 31, 2021.

Further, in terms of Regulation 49(1) of the SEBI ICDR Regulations, our Company shall ensure that the number of Bidders to whom the Equity Shares will be Allotted will be not less than 1,000. It is clarified that, subject to applicable laws, none of the Selling Shareholders shall be liable to pay any amounts as interest for any delay, unless such default or delay is solely and directly attributable to an act or omission of such Selling Shareholders.

In the event of under subscription in the Offer, the Equity Shares will be allotted in the following order:

- (i) all the Equity Shares offered by the Investor Selling Shareholders will be allotted;
- (ii) next, the Equity Shares offered by the Individual Selling Shareholders will be allotted; and
- (iii) next, the Equity Shares offered by the Promoter Group Selling Shareholders will be allotted.

#### **Arrangements for Disposal of Odd Lots**

Since the Equity Shares will be treated in dematerialised form only, and the market lot for the Equity Shares will be one Equity Share, there are no arrangements for disposal of odd lots.

#### **New Financial Instruments**

Our Company is not issuing any new financial instruments through this Offer.

#### **Option to receive Equity Shares in Dematerialized Form**

Allotment of Equity Shares to successful Bidders will only be in the dematerialized form. Bidders will not have the option of Allotment of the Equity Shares in physical form. The Equity Shares on Allotment will be traded only in the dematerialized segment of the Stock Exchanges.

#### **Restrictions, if any on Transfer and Transmission of Equity Shares**

Except for lock-in of pre-Offer equity shareholding of our Company, lock-in of our Promoters' contribution and Anchor Investor lock-in, as detailed in "*Capital Structure*" on page 87 and as provided in our Articles as detailed in "*Main Provisions of the Articles of Association*" on page 436, there are no restrictions on transfers and transmission of shares/debentures and on their consolidation or splitting.

#### **Withdrawal of the Offer**

Our Company and the Investor Selling Shareholders, in consultation with the BRLMs, reserves the right not to proceed with the Offer after the Bid/ Offer Opening Date but before the Allotment. In such an event, our Company would issue a public notice in the newspapers in which the pre-Offer advertisements were published, within two days of the Bid/ Offer Closing Date or such other time as may be prescribed by SEBI, providing reasons for not proceeding with the Offer. The BRLMs, through the Registrar to the Offer, shall notify the SCSBs and the Sponsor Bank, in case of UPI Bidders using the UPI Mechanism, to unblock the bank accounts of the ASBA Bidders and the BRLMs shall notify the Escrow Collection Bank to release the Bid Amounts to the Anchor Investors, within one Working Day from the date of receipt of such notification. Our Company shall also inform the same to the Stock Exchanges on which Equity Shares are proposed to be listed.

Notwithstanding the foregoing, the Offer is also subject to obtaining the final listing and trading approvals of the Stock Exchanges, which our Company shall apply for after Allotment and within six Working Days of the Bid/ Offer Closing Date or such other time period as prescribed under Applicable Law and also inform the Bankers to the Offer to process refunds to the Anchor Investors, as the case may be. If our Company withdraws the Offer after the Bid/ Offer Closing Date and thereafter determines that it will proceed with an issue or offer for sale of the Equity Shares, our Company shall file a fresh draft red herring prospectus with SEBI and the Stock Exchanges. The notice of withdrawal will be issued in the same newspapers where the pre-Offer advertisements have appeared, and the Stock Exchanges will also be informed promptly.

## OFFER STRUCTURE

Initial public offering of up to 15,731,942 Equity Shares of face value of ₹10 each, for cash at a price of ₹[●] per Equity Share comprising an Offer for Sale by the Selling Shareholders.

In terms of Rule 19(2) (b) of the SCRR, the Offer is being made through the Book Building Process, in compliance with Regulation 31 of the SEBI ICDR Regulations.

Particulars	QIBs <sup>(1)</sup>	Non-Institutional Investors	Retail Individual Investors
Number of Equity Shares available for Allotment or allocation <sup>*(2)</sup>	Not more than 7,865,970 Equity Shares aggregating up to ₹ [●] million	Not less than 2,359,792 Equity Shares aggregating up to ₹ [●] million.	Not less than 5,506,180 Equity Shares aggregating up to ₹ [●] million.
Percentage of Offer Size available for Allotment or allocation	Not more than 50% of the Offer shall be available for allocation to QIB Bidders. However, up to 5% of the QIB Portion will be available for allocation proportionately to Mutual Funds only. Mutual Funds participating in the Mutual Fund Portion will also be eligible for allocation in the remaining QIB Portion (excluding the Anchor Investor portion). The unsubscribed portion in the Mutual Fund Portion will be available for allocation to other QIBs.	Not less than 15% of the Offer or the Offer less allocation to QIB Bidders and RIIs will be available for allocation. One-third of the Non-Institutional Category will be available for allocation to Bidders with an application size of more than ₹ 200,000 and up to ₹ 1,000,000 and two-thirds of the Non-Institutional Category will be available for allocation to Bidders with an application size of more than ₹ 1,000,000.	Not less than 35% of the Offer or the Offer less allocation to QIB Bidders and Non-Institutional Investors will be available for allocation.
Basis of Allotment if respective category is oversubscribed*	Proportionate as follows (excluding the Anchor Investor Portion): a) up to 157,319 Equity Shares shall be available for allocation on a proportionate basis to Mutual Funds only; b) up to 2,989,069 Equity Shares shall be available for allocation on a proportionate basis to all QIBs, including Mutual Funds receiving allocation as per (a) above; and c) up to 4,719,582 Equity Shares may be allocated on a discretionary basis to Anchor Investors.	Proportionate, however, the allotment of specified securities to each Non-Institutional Investor shall not be less than the minimum application size, subject to availability in the Non-Institutional Category, and the remainder, if any, shall be allotted on a proportionate basis in accordance with the conditions specified in the SEBI ICDR Regulations	The allotment to each RII shall not be less than the minimum Bid Lot, subject to availability of Equity Shares in the Retail Portion and the remaining available Equity Shares if any, shall be Allotted on a proportionate basis. For further details, see “ <i>Offer Procedure</i> ” beginning on page 417.
Mode of Bid	Through ASBA Process only (except in case of Anchor Investors, which shall include the UPI Mechanism for UPI Bidders). In case of UPI Bidders through the UPI Mechanism.		
Minimum Bid	Such number of Equity Shares in multiples of [●] Equity Shares such that the Bid Amount exceeds ₹ 200,000	Such number of Equity Shares in multiples of [●] Equity Shares such that the Bid Amount exceeds ₹ 200,000	[●] Equity Shares and in multiples of [●] Equity Shares thereafter
Maximum Bid	Such number of Equity Shares in multiples of [●] Equity Shares not exceeding the size of the Offer, subject to applicable limits	Such number of Equity Shares in multiples of [●] Equity Shares not exceeding the size of the Offer, (excluding the QIB Portion) subject to limits applicable to the Bidder	Such number of Equity Shares in multiples of [●] Equity Shares so that the Bid Amount does not exceed ₹ 200,000
Mode of Allotment	Compulsorily in dematerialised form		
Bid Lot	[●] Equity Shares and in multiples of [●] Equity Shares thereafter		
Allotment Lot	[●] Equity Shares and in multiples of one Equity Share thereafter		



Particulars	QIBs <sup>(1)</sup>	Non-Institutional Investors	Retail Individual Investors
Trading Lot	One Equity Share		
Who can apply <sup>(3)(5)(6)</sup>	Public financial institutions of the Companies Act, scheduled commercial banks, multilateral and bilateral development financial institutions, Mutual Funds, FPIs other than individuals, corporate bodies and family offices, VCFs, AIFs, FVCIs, state industrial development corporation, insurance company registered with IRDAI, provident funds with minimum corpus of ₹250 million, pension funds with minimum corpus of ₹250 million, National Investment Fund set up by the GoI, insurance funds set up and managed by army, navy or air force of the Union of India, insurance funds set up and managed by the Department of Posts, India and Systemically Important NBFCs.	Resident Indian individuals, Eligible NRIs, HUFs (in the name of the karta), companies, corporate bodies, scientific institutions, societies, and trusts and any individuals, corporate bodies and family offices which are re-categorised as category II FPI (as defined in the SEBI FPI Regulations) and registered with SEBI.	Resident Indian individuals, Eligible NRIs and HUFs (in the name of the Karta)
Terms of Payment	<p><b>In case of Anchor Investors:</b> Full Bid Amount shall be payable by the Anchor Investors at the time of submission of their Bids<sup>(4)</sup></p> <p><b>In case of all other Bidders:</b> Full Bid Amount shall be blocked in the bank account of the ASBA Bidder (other than Anchor Investors), or by the Sponsor Bank through the UPI Mechanism, that is specified in the ASBA Form at the time of submission of the ASBA Form</p>		

\* Assuming full subscription in the Offer.

- (1) Our Company and the Investor Selling Shareholders may, in consultation with the BRLMs, allocate up to 60% of the QIB Portion to Anchor Investors at the Anchor Investor Offer Price, on a discretionary basis, subject to there being (i) a maximum of two Anchor Investors, where allocation in the Anchor Investor Portion is up to ₹100 million, (ii) minimum of two and maximum of 15 Anchor Investors, where the allocation under the Anchor Investor Portion is more than ₹100 million but up to ₹2,500 million under the Anchor Investor Portion, subject to a minimum Allotment of ₹50 million per Anchor Investor, and (iii) in case of allocation above ₹2,500 million under the Anchor Investor Portion, a minimum of five such investors and a maximum of 15 Anchor Investors for allocation up to ₹2,500 million, and an additional 10 Anchor Investors for every additional ₹2,500 million or part thereof will be permitted, subject to minimum allotment of ₹50 million per Anchor Investor. An Anchor Investor will make a minimum Bid of such number of Equity Shares, that the Bid Amount is at least ₹100 million. One-third of the Anchor Investor Portion will be reserved for domestic Mutual Funds, subject to valid Bids being received at or above the price at which allocation is made to Anchor Investors, which price shall be determined by the Company and the Investor Selling Shareholders in consultation with the BRLMs.
- (2) Subject to valid Bids being received at or above the Offer Price. This Offer is being made in accordance with Rule 19(2)(b) of the SCRR and Regulation 6(1) of the SEBI ICDR Regulations.
- (3) In case of joint Bids, the Bid cum Application Form should contain only the name of the first Bidder whose name should also appear as the first holder of the beneficiary account held in joint names. The signature of only such first Bidder would be required in the Bid cum Application Form and such first Bidder would be deemed to have signed on behalf of the joint holders.
- (4) Full Bid Amount shall be payable by the Anchor Investors at the time of submission of the Anchor Investor Application Forms provided that any difference between the Anchor Investor Allocation Price and the Anchor Investor Offer Price shall be payable by the Anchor Investor pay-in date as indicated in the CAN.
- (5) Bids by FPIs with certain structures as described under “Offer Procedure – Bids by FPIs” on page 422 and having the same PAN may be collated and identified as a single Bid in the Bidding process. The Equity Shares Allocated and Allotted to such successful Bidders (with the same PAN) may be proportionately distributed.
- (6) Bidders will be required to confirm and will be deemed to have represented to our Company, the Selling Shareholders, the Underwriters, their respective directors, officers, agents, affiliates and representatives that they are eligible under applicable law, rules, regulations, guidelines and approvals to acquire the Equity Shares.

Subject to valid Bids being received at or above the Offer Price, under-subscription, if any, in the Non-Institutional Category or the Retail Portion would be allowed to be met with spill over from any other category or a combination of categories at the discretion of our Company in consultation with the BRLMs and the Designated Stock

Exchange. However, under-subscription, if any, in the QIB Portion will not be allowed to be met with spill-over from other categories or a combination of categories. For further details, see “*Terms of the Offer*” on page 408.

## OFFER PROCEDURE

All Bidders should read the General Information Document for Investing in Public Issues prepared and issued in accordance with the circular no. SEBI/HO/CFD/DIL1/CIR/P/2020/37 dated March 17, 2020 and the UPI Circulars (the “**General Information Document**”) which highlights the key rules, processes and procedures applicable to public issues in general in accordance with the provisions of the Companies Act, 2013, the SCRA, the SCRR and the SEBI ICDR Regulations. The General Information Document is available on the websites of the Stock Exchanges and the BRLMs. Please refer to the relevant provisions of the General Information Document which are applicable to the Offer, especially in relation to the process for Bids by UPI Bidders through the UPI Mechanism. The investors should note that the details and process provided in the General Information Document should be read along with this section.

Additionally, all Bidders may refer to the General Information Document for information in relation to (i) category of investors eligible to participate in the Offer; (ii) maximum and minimum Bid size; (iii) price discovery and allocation; (iv) payment instructions for ASBA Bidders; (v) issuance of Confirmation of Allocation Note (“**CAN**”) and Allotment in the Offer; (vi) general instructions (limited to instructions for completing the Bid cum Application Form); (vii) Designated Date; (viii) disposal of applications; (ix) submission of Bid cum Application Form; (x) other instructions (limited to joint bids in cases of individual, multiple bids and instances when an application would be rejected on technical grounds); (xi) applicable provisions of Companies Act, 2013 relating to punishment for fictitious applications; (xii) mode of making refunds; and (xiii) interest in case of delay in Allotment or refund.

SEBI through its circular (SEBI/HO/CFD/DIL2/CIR/P/2018/138) dated November 1, 2018 as amended from time to time, including pursuant to circular (SEBI/HO/CFD/DIL2/CIR/P/2019/50) dated April 3, 2019 has proposed to introduce an alternate payment mechanism using Unified Payments Interface (“**UPI**”) and consequent reduction in timelines for listing in a phased manner. UPI has been introduced in a phased manner as a payment mechanism with the ASBA for applications by Retail Individual Investors through intermediaries from January 1, 2019. The UPI Mechanism for Retail Individual Investors applying through Designated Intermediaries, in phase I, was effective along with the prior process and existing timeline of T+6 days (“**UPI Phase I**”), until June 30, 2019. Subsequently, for applications by Retail Individual Investors through Designated Intermediaries, the process of physical movement of forms from Designated Intermediaries to SCSBs for blocking of funds has been discontinued and only the UPI Mechanism with existing timeline of T+6 days is applicable for a period of three months or launch of five main board public issues, whichever is later (“**UPI Phase II**”), with effect from July 1, 2019, by SEBI circular (SEBI/HO/CFD/DIL2/CIR/P/2019/76) dated June 28, 2019, read with circular (SEBI/HO/CFD/DIL2/CIR/P/2019/85) dated July 26, 2019. Further, as per the SEBI circular (SEBI/HO/CFD/DCR2/CIR/P/2019/133) dated November 8, 2019, the UPI Phase II had been extended until March 31, 2020. However, due to the outbreak of COVID-19 pandemic, UPI Phase II has been further extended by SEBI until further notice, by its circular (SEBI/HO/CFD/DIL2/CIR/P/2020/50) dated March 30, 2020. Thereafter, the final reduced timeline of T+3 days may be made effective using the UPI Mechanism for applications by Retail Individual Investors (“**UPI Phase III**”), as may be prescribed by SEBI. Accordingly, the Offer will be undertaken pursuant to the processes and procedures under UPI Phase II, subject to any circulars, clarification or notification issued by the SEBI from time to time. Further, SEBI vide its circular no. SEBI/HO/CFD/DIL2/CIR/P/2021/2480/1/M dated March 16, 2021 read with circular no. SEBI/HO/CFD/DIL2/P/CIR/2021/570 dated June 2, 2021 and SEBI circular no. SEBI/HO/CFD/DIL2/CIR/P/2022/51 dated April 20, 2022 has introduced certain additional measures for streamlining the process of initial public offers and redressing investor grievances. Furthermore, pursuant to SEBI circular no. SEBI/HO/CFD/DIL2/P/CIR/P/2022/45 dated April 5, 2022, all individual bidders in initial public offerings (opening on or after May 1, 2022) whose application sizes are up to ₹500,000 shall use the UPI Mechanism. These circular have come into force for initial public offers opening on or after May 1, 2021 and the provisions of these circular are deemed to form part of this Draft Red Herring Prospectus.

In case of any delay in unblocking of amounts in the ASBA Accounts (including amounts blocked through the UPI Mechanism) exceeding four Working Days from the Bid/Offer Closing Date, the Bidder shall be compensated at a uniform rate of ₹100 per day for the entire duration of delay exceeding four Working Days from the Bid/Offer Closing Date by the intermediary responsible for causing such delay in unblocking. The BRLMs shall, in their sole discretion, identify and fix the liability on such intermediary or entity responsible for such delay in unblocking. Further, SEBI vide its circular no. SEBI/HO/CFD/DIL1/CIR/P/2021/47 dated March 31, 2021, has reduced the timelines for refund of Application money to four days.

The BRLMs shall be the nodal entity for any issues arising out of public issuance process.

*Our Company, the Selling Shareholders, the BRLMs and the members of the Syndicate do not accept any responsibility for the completeness and accuracy of the information stated in this section and the General Information Document and are not liable for any amendment, modification or change in the applicable law which may occur after the date of this Draft Red Herring Prospectus and the Red Herring Prospects. Bidders are advised to make their independent investigations and ensure that their Bids are submitted in accordance with applicable laws and do not exceed the investment limits or maximum number of Equity Shares that can be held by them under applicable law or as specified in this Draft Red Herring Prospectus, the Red Herring Prospectus and the Prospectus.*

### **Book Building Procedure**

The Offer is being made through the Book Building Process in accordance with Regulation 6(1) of the SEBI ICDR Regulations wherein not more than 50% of the Offer shall be available for allocation to QIBs on a proportionate basis, provided that our Company and the Investor Selling Shareholders in consultation with the BRLMs may allocate up to 60% of the QIB Portion to Anchor Investors on a discretionary basis in accordance with the SEBI ICDR Regulations, of which one-third shall be reserved for domestic Mutual Funds, subject to valid Bids being received from them at or above the Anchor Investor Allocation Price. 5% of the net QIB Portion (excluding the Anchor Investor Portion) shall be available for allocation on a proportionate basis to Mutual Funds only, and the remainder of the QIB Portion shall be available for allocation on a proportionate basis to all QIB Bidders (other than Anchor Investors), including Mutual Funds, subject to valid Bids being received at or above the Offer Price. Further, not less than 15% of the Offer shall be available for allocation to Non-Institutional Investors of which one-third of the Non-Institutional Category will be available for allocation to Bidders with an application size of more than ₹ 200,000 and up to ₹ 1,000,000 and two-thirds of the Non-Institutional Category will be available for allocation to Bidders with an application size of more than ₹ 1,000,000 and under-subscription in either of these two sub-categories of Non-Institutional Category may be allocated to Bidders in the other sub-category of Non-Institutional Category. Further, not less than 35% of the Offer shall be available for allocation to Retail Individual Bidders in accordance with the SEBI ICDR Regulations, subject to valid Bids being received at or above the Offer Price.

Under-subscription, if any, in any category, except in the QIB Portion, would be allowed to be met with spill over from any other category or combination of categories, at the discretion of our Company in consultation with the BRLMs and the Designated Stock Exchange. The Equity Shares, on Allotment, shall be traded only in the dematerialized segment of the Stock Exchanges. Investors should note that the Equity Shares will be Allotted to all successful Bidders only in dematerialised form. The Bid cum Application Forms which do not have the details of the Bidders' depository account, including DP ID, Client ID and PAN, shall be treated as incomplete and will be rejected. Bidders will not have the option of being Allotted Equity Shares in physical form. However, they may get the Equity Shares rematerialized subsequent to Allotment of the Equity Shares in the IPO.

The Equity Shares, on Allotment, shall be traded only in the dematerialised segment of the Stock Exchanges.

Investors should note that the Equity Shares will be Allotted to all successful Bidders only in dematerialised form. The Bid cum Application Forms which do not have the details of the Bidders' depository account, including DP ID, Client ID, PAN and UPI ID, as applicable, shall be treated as incomplete and will be rejected. Bidders will not have the option of being Allotted Equity Shares in physical form. However, they may get the Equity Shares rematerialized subsequent to Allotment of the Equity Shares offered in the Offer, subject to applicable laws.

### **Phased implementation of Unified Payments Interface**

SEBI has issued the UPI Circulars in relation to streamlining the process of public issue of *inter alia* equity shares. Pursuant to the UPI Circulars, the UPI Mechanism has been introduced in a phased manner as a payment mechanism (in addition to mechanism of blocking funds in the account maintained with SCSBs under ASBA) for applications by RIIs through Designated Intermediaries with the objective to reduce the time duration from public issue closure to listing from six Working Days up to three Working Days. Considering the time required for making necessary changes to the systems and to ensure complete and smooth transition to the UPI payment mechanism, the UPI Circulars have introduced the UPI Mechanism in three phases in the following manner:

**Phase I:** This phase was applicable from January 1, 2019 until March 31, 2019 or floating of five main board public issues, whichever was later. Subsequently, the timeline for implementation of Phase I was extended till June 30, 2019. Under this phase, an RII had the option to submit the ASBA Form with any of the Designated Intermediary and use his/her UPI ID for the purpose of blocking of funds. The time duration from public issue closure to listing continued to be six Working Days.

**Phase II:** This phase has become applicable from July 1, 2019 and was to initially continue for a period of three months or floating of five main board public issues, whichever is later. SEBI vide its circular no. SEBI/HO/CFD/DCR2/CIR/P/2019/133 dated November 8, 2019 has decided to extend the timeline for implementation of UPI Phase II until March 31, 2020. Subsequently, SEBI vide its circular no. SEBI/HO/CFD/DIL2/CIR/P/2020/50 dated March 30, 2020 extended the timeline for implementation of UPI Phase II till further notice. Under this phase, submission of the ASBA Form by RIBs through Designated Intermediaries (other than SCSBs) to SCSBs for blocking of funds has been discontinued and replaced by the UPI Mechanism. However, the time duration from public issue closure to listing continues to be six Working Days during this phase.

**Phase III:** The commencement period of Phase III is yet to be notified. In this phase, the time duration from public issue closure to listing is proposed to be reduced to three Working Days. Accordingly, upon commencement of Phase III, the reduced time duration shall be applicable for the Offer.

The Offer will be made under UPI Phase II of the UPI Circulars, unless UPI Phase III of the UPI Circulars becomes effective and applicable on or prior to the Bid/Offer Opening Date. If the Offer is made under UPI Phase III of the UPI Circulars, the same will be advertised in shall be advertised in all editions of [●] (a widely circulated English national daily newspaper) and all editions of [●] (a widely circulated Hindi national daily newspaper, Hindi also being the regional language of New Delhi, where our Registered Office is located), on or prior to the Bid/Offer Opening Date and such advertisement shall also be made available to the Stock Exchanges for the purpose of uploading on their websites.

All SCSBs offering the facility of making application in public issues shall also provide facility to make application using UPI. Our Company will be required to appoint one of the SCSBs as a sponsor bank to act as a conduit between the Stock Exchanges and NPCI in order to facilitate collection of requests and/or payment instructions of the Retail Individual Investors using the UPI.

Pursuant to the UPI Circulars, SEBI has set out specific requirements for redressal of investor grievances for applications that have been made through the UPI Mechanism. The requirements of the UPI Circular include, appointment of a nodal officer by the SCSB and submission of their details to SEBI, the requirement for SCSBs to send SMS alerts for the blocking and unblocking of UPI mandates, the requirement for the Registrar to submit details of cancelled, withdrawn or deleted applications, and the requirement for the bank accounts of unsuccessful Bidders to be unblocked no later than one Working Day from the date on which the Basis of Allotment is finalised. Failure to unblock the accounts within the timeline would result in the SCSBs being penalised under the relevant securities law. Additionally, if there is any delay in the redressal of investors' complaints, the relevant SCSB as well as the post – Offer BRLMs will be required to compensate the concerned investor.

For further details, refer to the General Information Document available on the websites of the Stock Exchanges and the BRLMs.

### **Electronic registration of Bids**

- a) The Designated Intermediary may register the Bids using the online facilities of the Stock Exchanges. The Designated Intermediaries can also set up facilities for off-line electronic registration of Bids, subject to the condition that they may subsequently upload the off-line data file into the online facilities for Book Building on a regular basis before the closure of the Offer.
- b) On the Bid/Offer Closing Date, the Designated Intermediaries may upload the Bids till such time as may be permitted by the Stock Exchanges and as disclosed in the Red Herring Prospectus.
- c) Only Bids that are uploaded on the Stock Exchanges Platform are considered for allocation/Allotment.

### **Bid cum Application Form**

Copies of the Bid cum Application Form (other than for Anchor Investors) and the abridged prospectus will be available with the Designated Intermediaries at the Bidding Centres, and our Registered Office. An electronic copy of the Bid cum Application Form will also be available for download on the websites of BSE ([www.bseindia.com](http://www.bseindia.com)) and NSE ([www.nseindia.com](http://www.nseindia.com)) at least one day prior to the Bid/Offer Opening Date.

Copies of the Anchor Investor Application Form will be available at the offices of the BRLMs.

All Bidders (other than Anchor Investors) shall mandatorily participate in the Offer only through the ASBA process, which shall include the UPI Mechanism in the case of UPI Bidders.

ASBA Bidders must provide either (i) the bank account details and authorisation to block funds in the ASBA Form, or (ii) the UPI ID, as applicable, in the relevant space provided in the ASBA Form. The ASBA Forms that do not contain such details are liable to be rejected. Applications made by the RIIs using third party bank account or using third party linked bank account UPI ID are liable for rejection. Anchor Investors are not permitted to participate in the Offer through the ASBA process. ASBA Bidders shall ensure that the Bids are made on ASBA Forms bearing the stamp of the relevant Designated Intermediary, submitted at the relevant Bidding Centres only (except in case of electronic ASBA Forms) and the ASBA Forms not bearing such specified stamp are liable to be rejected. Since the Offer is made under Phase II of the UPI Circulars, ASBA Bidders may submit the ASBA Form in the manner below:

- (i) RIIs (other than the RIIs using UPI Mechanism) may submit their ASBA Forms with SCSBs (physically or online, as applicable), or online using the facility of linked online trading, demat and bank account (3 in 1 type accounts), provided by certain brokers.
- (ii) UPI Bidders using the UPI Mechanism may submit their ASBA Forms with the Syndicate, sub-syndicate members, Registered Brokers, RTAs or CDPs, or online using the facility of linked online trading, demat and bank account (3 in 1 type accounts), provided by certain brokers.
- (iii) QIBs and NIIs may submit their ASBA Forms with SCSBs, Syndicate, sub-syndicate members, Registered Brokers, RTAs or CDPs.

ASBA Bidders, including UPI Bidders, are also required to ensure that the ASBA Account has sufficient credit balance as an amount equivalent to the full Bid Amount which can be blocked by the SCSB.

For Anchor Investors, the Anchor Investor Application Form will be available at the offices of the BRLMs.

The prescribed colour of the Bid cum Application Form for the various categories is as follows:

Category	Colour of Bid cum Application Form*
Resident Indians, including resident QIBs, Non-Institutional Investors, Retail Individual Investors and Eligible NRIs applying on a non-repatriation basis <sup>^</sup>	[●]
Eligible NRIs, FVCIs, FPIs and registered bilateral and multilateral institutions applying on a repatriation basis	[●]
Anchor Investors	[●]

<sup>\*</sup>Excluding the electronic Bid cum Application Form.

<sup>^</sup>Electronic Bid cum Application Form will be made available for download on the website of the BSE ([www.bseindia.com](http://www.bseindia.com)) and NSE ([www.nseindia.com](http://www.nseindia.com)).

<sup>^^</sup>Bid cum Application Forms for Anchor Investors were made available at the offices of the BRLMs.

In case of ASBA forms, the relevant Designated Intermediaries shall upload the relevant bid details (including UPI ID in case of ASBA Forms under the UPI Mechanism) in the electronic bidding system of the Stock Exchanges. For UPI Bidders using the UPI Mechanism, the Stock Exchanges shall share the Bid details (including UPI ID) with the Sponsor Bank on a continuous basis to enable the Sponsor Bank to initiate UPI Mandate Request to UPI Bidders for blocking of funds. For ASBA Forms (other than UPI Bidders) Designated Intermediaries (other than SCSBs) shall submit/ deliver the ASBA Forms to the respective SCSB where the Bidder has an ASBA bank account and shall not submit it to any non-SCSB bank or any Escrow Collection Bank. Stock Exchanges shall validate the electronic bids with the records of the CDP for DP ID / Client ID and PAN, on a real time basis and bring inconsistencies to the notice of the relevant Designated Intermediaries, for rectification and re-submission within the time specified by Stock Exchanges. Stock Exchanges shall allow modification of either DP ID / Client ID or PAN ID, bank code and location code in the Bid details already uploaded.

For UPI Bidders using UPI Mechanism, the Stock Exchanges shall share the Bid details (including UPI ID) with the Sponsor Bank on a continuous basis through API integration to enable the Sponsor Bank to initiate UPI Mandate Request to the UPI Bidders, for blocking of funds. The Sponsor Bank shall initiate request for blocking of funds through NPCI to the UPI Bidders, who shall accept the UPI Mandate Request for blocking of funds on their respective mobile applications associated with UPI ID linked bank account. The NPCI shall maintain an audit trail for every Bid entered in the Stock Exchanges bidding platform, and the liability to compensate UPI Bidders in case of failed transactions shall be with the concerned entity (i.e. the Sponsor Bank, NPCI or the issuer bank) at whose end the lifecycle of the transaction has come to a halt. The NPCI shall share the audit trail of all

disputed transactions/ investor complaints to the Sponsor Banks and the issuer bank. The Sponsor Banks and the Bankers to the Issue shall provide the audit trail to the BRLMs for analysing the same and fixing liability. For ensuring timely information to investors, SCSBs shall send SMS alerts for mandate block and unblock including details specified in SEBI circular no. SEBI/HO/CFD/DIL2/CIR/P/2021/2480/1/M dated March 16, 2021 as amended pursuant to SEBI circular no. SEBI/HO/CFD/DIL2/P/CIR/2021/570 dated June 2, 2021 and SEBI circular no. SEBI/HO/CFD/DIL2/CIR/P/2022/51 dated April 20, 2022. For all pending UPI Mandate Requests, the Sponsor Bank shall initiate requests for blocking of funds in the ASBA Accounts of relevant Bidders with a confirmation cut-off time of 12:00 pm on the first Working Day after the Bid/Issue Closing Date (“**Cut-Off Time**”). Accordingly, UPI Bidders Bidding using through the UPI Mechanism should accept UPI Mandate Requests for blocking off funds prior to the Cut-Off Time and all pending UPI Mandate Requests at the Cut-Off Time shall lapse.

The Sponsor Bank will undertake a reconciliation of Bid responses received from Stock Exchanges and sent to NPCI and will also ensure that all the responses received from NPCI are sent to the Stock Exchanges platform with detailed error code and description, if any. Further, the Sponsor Bank will undertake reconciliation of all Bid requests and responses throughout their lifecycle on daily basis and share reports with the BRLMs in the format and within the timelines as specified under the UPI Circulars. Sponsor Bank and issuer banks shall download UPI settlement files and raw data files from the NPCI portal after every settlement cycle and do a three-way reconciliation with UPI switch data, CBS data and UPI raw data. NPCI is to coordinate with issuer banks and Sponsor Banks on a continuous basis.

**The Equity Shares offered in the Offer have not been and will not be registered under the U.S. Securities Act or any state securities laws in the United States, and may not be offered or sold within the United States, except pursuant to an exemption from, or in a transaction not subject to, the registration requirements of the U.S. Securities Act and applicable state securities laws in the United States. Accordingly, the Equity Shares are being offered and sold outside the United States in offshore transactions in compliance with Regulation S and the applicable laws of the jurisdiction where those offers and sales are made.**

**The Equity Shares have not been and will not be registered, listed or otherwise qualified in any other jurisdiction outside India and may not be offered or sold, and Bids may not be made by persons in any such jurisdiction, except in compliance with the applicable laws of such jurisdiction.**

**Participation by Promoter and Members of the Promoter Group, the BRLMs, associates and affiliates of the BRLMs and the Syndicate Members and the persons related to BRLMs and the Syndicate Member**

The BRLMs and the Syndicate Members shall not be allowed to purchase Equity Shares in this Offer in any manner, except towards fulfilling their respective underwriting obligations. However, the respective associates and affiliates of the BRLMs and the Syndicate Members may Bid for Equity Shares in the Offer, either in the QIB Portion or in the Non-Institutional Category as may be applicable to such Bidders, where the allocation is on a proportionate basis, and such subscription may be on their own account or on behalf of their clients. All categories of investors, including associates or affiliates of the BRLMs and Syndicate Members, shall be treated equally for the purpose of allocation to be made on a proportionate basis.

Except as stated below, neither the BRLMs nor any persons related to the BRLMs can apply in the Offer under the Anchor Investor Portion:

- (i) mutual funds sponsored by entities which are associate of the BRLMs;
- (ii) insurance companies promoted by entities which are associate of the BRLMs;
- (iii) AIFs sponsored by the entities which are associate of the BRLMs; or
- (iv) FPIs other than individuals, corporate bodies and family offices sponsored by the entities which are associate of the BRLMs.

For the purposes of the above, a QIB who has any of the following rights shall be deemed to be a “person related to the Promoter or Promoter Group”: (a) rights under a shareholders’ agreement or voting agreement entered into with the Promoter or Promoter Group; (b) veto rights; or (c) right to appoint any nominee director on our Board.

Further, an Anchor Investor shall be deemed to be an “associate of the BRLM” if:

- (i) either of them controls, directly or indirectly through its subsidiary or holding company, not less than

15% of the voting rights in the other; or

- (ii) either of them, directly or indirectly, by itself or in combination with other persons, exercises control over the other; or
- (iii) there is a common director, excluding nominee director, amongst the Anchor Investors and the BRLMs.

The Promoters and the members of the Promoter Group, except to the extent of their respective Offered Shares, will not participate in the Offer. Further, persons related to our Promoter and Promoter Group shall not apply in the Offer under the Anchor Investor Portion.

### **Bids by Mutual Funds**

With respect to Bids by Mutual Funds, a certified copy of their SEBI registration certificate must be lodged along with the Bid cum Application Form. Failing this, our Company and the Investor Selling Shareholders, in consultation with the BRLMs, reserve the right to reject any Bid without assigning any reason thereof.

Bids made by asset management companies or custodians of Mutual Funds shall specifically state names of the concerned schemes for which such Bids are made.

In case of a Mutual Fund, a separate Bid can be made in respect of each scheme of the Mutual Fund registered with SEBI and such Bids in respect of more than one scheme of the Mutual Fund will not be treated as multiple Bids provided that the Bids clearly indicate the scheme concerned for which the Bid has been made.

No Mutual Fund scheme shall invest more than 10% of its NAV in equity shares or equity related instruments of any single company provided that the limit of 10% shall not be applicable for investments in case of index funds or sector or industry specific schemes. No Mutual Fund under all its schemes should own more than 10% of any company's paid-up share capital carrying voting rights.

### **Bids by Eligible NRIs**

Eligible NRIs may obtain copies of Bid cum Application Form from the Designated Intermediaries. Eligible NRI Bidders bidding on a repatriation basis by using the Non-Resident forms should authorise their SCSB to block their Non-Resident External (“NRE”) accounts (including UPI ID, if activated), or Foreign Currency Non-Resident (“FCNR”) accounts, and eligible NRI Bidders bidding on a non-repatriation basis by using resident forms should authorise their SCSB to block their Non-Resident Ordinary (“NRO”) accounts for the full Bid Amount, at the time of the submission of the Bid cum Application Form. NRIs applying in the Offer through the UPI Mechanism are advised to enquire with the relevant bank, whether their account is UPI linked, prior to submitting a Bid cum Application Form.

Eligible NRIs Bidding on non-repatriation basis are advised to use the Bid cum Application Form for residents (white in colour). Eligible NRIs Bidding on a repatriation basis are advised to use the Bid cum Application Form meant for Non-Residents (blue in colour).

Participation of Eligible NRIs in the Offer shall be subject to the FEMA Rules. Only bids accompanied by payment in Indian rupees or fully convertible foreign exchange will be considered for allotment.

For details of restrictions on investment by NRIs, see “*Restrictions on Foreign Ownership of Indian Securities*” on page 435.

### **Bids by HUFs**

Bids by Hindu Undivided Families or HUFs, in the individual name of the Karta. The Bidder should specify that the Bid is being made in the name of the HUF in the Bid cum Application Form as follows: “Name of sole or First Bidder: XYZ Hindu Undivided Family applying through XYZ, where XYZ is the name of the Karta”. Bids by HUFs may be considered at par with Bids from individuals.

### **Bids by FPIs**

In terms of the SEBI FPI Regulations, the issue of Equity Shares to a single FPI or an investor group (which means the same multiple entities having common ownership directly or indirectly of more than 50% or common control) must be below 10% of our post-Offer Equity Share capital. Further, in terms of the FEMA Rules, the total holding



by each FPI, of an investor group, shall be below 10% of the total paid-up Equity Share capital of our Company on a fully diluted basis and the aggregate limit for FPI investments shall be the sectoral caps applicable to our Company, which is 100% of the total paid-up Equity Share capital of our Company on a fully diluted basis. In case the total holding of an FPI or investor group increases beyond 10% of the total paid-up Equity Share capital of our Company, on a fully diluted basis, the total investment made by the FPI or investor group will be re-classified as FDI subject to the conditions as specified by SEBI and the RBI in this regard and our Company and the investor will be required to comply with applicable reporting requirements. Further, the total holdings of all FPIs put together, with effect from April 1, 2020, can be up to the sectoral cap applicable to the sector in which our Company operates (i.e., up to 100% under the automatic route).

In terms of the FEMA Rules, for calculating the aggregate holding of FPIs in a company, holding of all registered FPIs shall be included. Bids by FPIs which utilise the multi investment manager structure, submitted with the same PAN but with different beneficiary account numbers, Client IDs and DP IDs may not be treated as multiple Bids.

FPIs are permitted to participate in the Offer subject to compliance with conditions and restrictions which may be specified by the Government from time to time. In terms of the FEMA Rules, for calculating the aggregate holding of FPIs in a company, holding of all registered FPIs shall be included.

Subject to compliance with all applicable Indian laws, rules, regulations, guidelines and approvals in terms of Regulation 22 of the SEBI FPI Regulations, an FPI, may issue, subscribe to or otherwise deal in offshore derivative instruments (as defined under the SEBI FPI Regulations as any instrument, by whatever name called, which is issued overseas by a FPI against securities held by it in India, as its underlying) directly or indirectly, only in the event (i) such offshore derivative instruments are issued only by persons registered as Category I FPIs; (ii) such offshore derivative instruments are issued only to persons eligible for registration as Category I FPIs; (iii) such offshore derivative instruments are issued after compliance with 'know your client' norms; and (iv) such other conditions as may be specified by SEBI from time to time.

An FPI issuing offshore derivative instruments is also required to ensure that any transfer of offshore derivative instruments issued by, or on behalf of it subject to, inter alia, the following conditions:

- (a) such offshore derivative instruments are transferred to persons subject to fulfilment of SEBI FPI Regulations; and
- (b) prior consent of the FPI is obtained for such transfer, except when the persons to whom the offshore derivative instruments are to be transferred are pre-approved by the FPI.

The FPIs who wish to participate in the Offer are advised to use the Bid cum Application Form for non-residents.

Bids received from FPIs bearing the same PAN shall be treated as multiple Bids and are liable to be rejected, except for Bids from FPIs that utilize the multiple investment manager structure in accordance with the operational guidelines for FPIs and designated Depository Participants issued to facilitate implementation of SEBI FPI Regulations (such structure referred to as "**MIM Structure**"), provided such Bids have been made with different beneficiary account numbers, Client IDs and DP IDs.

Accordingly, it should be noted that multiple Bids received from FPIs, who do not utilize the MIM Structure, and bear the same PAN, are liable to be rejected. In order to ensure valid Bids, FPIs making multiple Bids using the same PAN, and with different beneficiary account numbers, Client IDs and DP IDs, are required to provide a confirmation in the Bid cum Application Forms that the relevant FPIs making multiple Bids utilize the MIM Structure. In the absence of such confirmation from the relevant FPIs, such multiple Bids shall be rejected.

Further, in the following cases, Bids by FPIs shall not be treated as multiple Bids:

- FPIs which utilise the MIM structure, indicating the name of their respective investment managers in such confirmation;
- Offshore derivative instruments which have obtained separate FPI registration for ODI and proprietary derivative investments;
- Sub funds or separate class of investors with segregated portfolio who obtain separate FPI registration;
- FPI registrations granted at investment strategy level/sub fund level where a collective investment scheme or fund has multiple investment strategies/sub-funds with identifiable differences and managed by a single investment manager;

- Multiple branches in different jurisdictions of foreign bank registered as FPIs;
- Government and Government related investors registered as Category 1 FPIs; and
- Entities registered as collective investment scheme having multiple share classes.

The Bids belonging to any of the above mentioned seven structures and having same PAN may be collated and identified as a single Bid in the Bidding process. The Equity Shares allotted in the Bid may be proportionately distributed to the applicant FPIs (with same PAN). In order to ensure valid Bids, FPIs making multiple Bids using the same PAN, and with different beneficiary account numbers, Client IDs and DP IDs, are required to provide a confirmation along with each of their Bid cum Application Forms that the relevant FPIs making multiple Bids utilize any of the above-mentioned structures and indicate the name of their respective investment managers in such confirmation. In the absence of such confirmation from the relevant FPIs, such multiple Bids shall be rejected.

#### **Bids by SEBI registered VCFs, AIFs and FVCIs**

The SEBI VCF Regulations, amongst others, prescribe the investment restrictions on VCFs, registered with SEBI. The SEBI AIF Regulations, amongst others, prescribe the investment restrictions on AIFs. The SEBI FVCI Regulations prescribe the investment restrictions on FVCIs.

Accordingly, the holding in any company by any individual VCF or FVCIs registered with SEBI should not exceed 25% of the corpus of the VCF or FVCI. Further, VCFs and FVCIs can invest only up to 33.33% of the investible funds in various prescribed instruments, including in public offering.

Category I and II AIFs cannot invest more than 25% of the investible funds in one investee company. A Category III AIF cannot invest more than 10% of the investible funds in one investee company. A VCF registered as a Category I AIF, as defined in the SEBI AIF Regulations, cannot invest more than one-third of its investible funds by way of subscription to an initial public offering of a venture capital undertaking whose shares are proposed to be listed. Additionally, the VCFs which have not re-registered as an AIF under the SEBI AIF Regulations shall continue to be regulated by the SEBI VCF Regulations until the existing fund or scheme managed by the fund is wound up and such funds shall not launch any new scheme after the notification of the SEBI AIF Regulations.

**All non-resident investors should note that refunds (in case of Anchor Investors), dividends and other distributions, if any, will be payable in Indian Rupees only and net of bank charges and commission.**

**Our Company, the Selling Shareholders or the BRLMs will not be responsible for loss, if any, incurred by the Bidder on account of conversion of foreign currency.**

Participation of AIFs, VCFs and FVCIs shall also be subject to the FEMA Rules.

#### **Bids by Limited Liability Partnerships**

In case of Bids made by limited liability partnerships registered under the Limited Liability Partnership Act, 2008, a certified copy of certificate of registration issued under the Limited Liability Partnership Act, 2008, must be attached to the Bid cum Application Form. Failing this, our Company and the Investor Selling Shareholders, in consultation with the BRLMs, reserve the right to reject any Bid without assigning any reason thereof.

#### **Bids by banking companies**

In case of Bids made by banking companies registered with the RBI, certified copies of (i) the certificate of registration issued by the RBI, and (ii) the approval of such banking company's investment committee are required to be attached to the Bid cum Application Form. Failing this, our Company and the Investor Selling Shareholders, in consultation with the BRLMs, reserves the right to reject any Bid without assigning any reason thereof, subject to applicable law.

The investment limit for banking companies in non-financial services companies as per the Banking Regulation Act, 1949, as amended (the "**Banking Regulation Act**"), and Master Direction – Reserve Bank of India (Financial Services provided by Banks) Directions, 2016, as amended, is 10% of the paid-up share capital of the investee company or 10% of the bank's own paid-up share capital and reserves, whichever is lower. Further, the aggregate equity investments in subsidiaries and other entities engaged in financial and non-financial services, including overseas investments, cannot exceed 20% of the bank's paid-up share capital and reserves. However, a banking company may hold up to 30% of the paid-up share capital of the investee company with the prior approval of the

RBI, provided that the investee company is engaged in non-financial activities in which banking companies are permitted to engage under the Banking Regulation Act or the additional acquisition is through restructuring of debt, or to protect the bank's interest on loans/investments made to a company.

### **Bids by SCSBs**

SCSBs participating in the Offer are required to comply with the terms of the circulars bearing numbers CIR/CFD/DIL/12/2012 and CIR/CFD/DIL/1/2013 dated September 13, 2012 and January 2, 2013, respectively, issued by SEBI. Such SCSBs are required to ensure that for making applications on their own account using ASBA, they should have a separate account in their own name with any other SEBI registered SCSBs. Further, such account shall be used solely for the purpose of making application in public issues and clear demarcated funds should be available in such account for such applications.

### **Bids by Insurance Companies**

In case of Bids made by insurance companies registered with the IRDAI, a certified copy of certificate of registration issued by IRDAI must be attached to the Bid cum Application Form. Failing this, our Company and the Investor Selling Shareholders, in consultation with the BRLMs, reserve the right to reject any Bid without assigning any reason thereof, subject to applicable law.

The exposure norms for insurers, prescribed under the Insurance Regulatory and Development Authority of India (Investment) Regulations, 2016, as amended, are broadly set forth below:

- (a) equity shares of a company: the lower of 10%\* of the outstanding equity shares (face value) or 10% of the respective fund in case of life insurer or 10% of investment assets in case of general insurer or reinsurer or health insurer;
- (b) the entire group of the investee company: not more than 15% of the respective fund in case of a life insurer or 15% of investment assets in case of a general insurer or reinsurer or health insurer or 15% of the investment assets in all companies belonging to the group, whichever is lower; and
- (c) the industry sector in which the investee company operates: not more than 15% of the fund of a life insurer or a general insurer or a reinsurer or health insurer or 15% of the investment asset, whichever is lower.

The maximum exposure limit, in the case of an investment in equity shares, cannot exceed the lower of an amount of 10% of the investment assets of a life insurer or general insurer and the amount calculated under (a), (b) and (c) above, as the case may be.

*\*The above limit of 10% shall stand substituted as 15% of outstanding equity shares (face value) for insurance companies with investment assets of ₹2,500,000 million or more and 12% of outstanding equity shares (face value) for insurers with investment assets of ₹500,000 million or more but less than ₹2,500,000 million.*

Insurance companies participating in the Offer shall comply with all applicable regulations, guidelines and circulars issued by IRDAI from time to time.

### **Bids by Provident Funds/Pension Funds**

In case of Bids made by provident funds/pension funds with minimum corpus of ₹250 million, subject to applicable law, a certified copy of a certificate from a chartered accountant certifying the corpus of the provident fund/pension fund must be attached to the Bid cum Application Form. Failing this, our Company and the Investor Selling Shareholders, in consultation with the BRLMs reserve the right to reject any Bid, without assigning any reason thereof.

### **Bids under Power of Attorney**

In case of Bids made pursuant to a power of attorney by limited companies, corporate bodies, registered societies, eligible FPIs, AIFs, Mutual Funds, insurance companies, NBFC-SI, insurance funds set up by the army, navy or air force of the India, insurance funds set up by the Department of Posts, India or the National Investment Fund and provident funds with a minimum corpus of ₹250 million (subject to applicable laws) and pension funds with a minimum corpus of ₹250 million, a certified copy of the power of attorney or the relevant resolution or authority, as the case may be, along with a certified copy of the memorandum of association and articles of association and/or bye laws must be lodged along with the Bid cum Application Form. Failing this, our Company and the Investor Selling Shareholders reserve the right to accept or reject any Bid in whole or in part, in either case, without assigning any reason thereof.

Our Company and the Investor Selling Shareholders in consultation with the BRLMs, in their absolute discretion, reserve the right to relax the above condition of simultaneous lodging of the power of attorney along with the Bid cum Application Form, subject to such terms and conditions that our Company and the Investor Selling Shareholders in consultation with the BRLMs, may deem fit.

### **Bids by Anchor Investors**

In accordance with the SEBI ICDR Regulations, in addition to details and conditions mentioned in this section, the key terms for participation by Anchor Investors are provided below:

- (a) Anchor Investor Application Forms will be made available for the Anchor Investor Portion at the offices of the BRLMs.
- (b) The Bid must be for a minimum of such number of Equity Shares so that the Bid Amount exceeds ₹100 million. A Bid cannot be submitted for over 60% of the QIB Portion. In case of a Mutual Fund, separate bids by individual schemes of a Mutual Fund will be aggregated to determine the minimum application size of ₹100 million.
- (c) One-third of the Anchor Investor Portion will be reserved for allocation to domestic Mutual Funds.
- (d) Bidding for Anchor Investors will open one Working Day before the Bid/Offer Opening Date, and will be completed on the same day.
- (e) Our Company and Selling Shareholders may finalise allocation to the Anchor Investors and the basis of such allocation will be on a discretionary basis by the Company, and the Investor Selling Shareholders, in consultation with the BRLMs, provided that the minimum number of Allottees in the Anchor Investor Portion will not be less than:
  - (i) maximum of two Anchor Investors, where allocation under the Anchor Investor Portion is up to ₹100 million;
  - (ii) minimum of two and maximum of 15 Anchor Investors, where the allocation under the Anchor Investor Portion is more than ₹100 million but up to ₹2,500 million, subject to a minimum Allotment of ₹50 million per Anchor Investor; and
  - (iii) in case of allocation above ₹2,500 million under the Anchor Investor Portion, a minimum of five such investors and a maximum of 15 Anchor Investors for allocation up to ₹2,500 million, and an additional 10 Anchor Investors for every additional ₹2,500 million, subject to minimum Allotment of ₹50 million per Anchor Investor.
- (f) Allocation to Anchor Investors will be completed on the Anchor Investor Bid/Offer Period. The number of Equity Shares allocated to Anchor Investors and the price at which the allocation is made, will be made available in the public domain by the BRLMs before the Bid/Offer Opening Date, through intimation to the Stock Exchanges.
- (g) Anchor Investors cannot withdraw or lower the size of their Bids at any stage after submission of the Bid.
- (h) If the Offer Price is greater than the Anchor Investor Allocation Price, the additional amount being the difference between the Offer Price and the Anchor Investor Offer Price will be payable by the Anchor Investors on the Anchor Investor pay-in date specified in the CAN. If the Offer Price is lower than the Anchor Investor Offer Price, Allotment to successful Anchor Investors will be at the higher price.
- (i) 50% Equity Shares Allotted to Anchor Investors in the Anchor Investor Portion shall be locked-in for a period of 90 days from the date of Allotment and the remaining 50% shall be locked-in for a period of 30 days from the date of Allotment.
- (j) Neither the BRLMs nor any associate of the BRLMs (except Mutual Funds sponsored by entities which are associates of the BRLMs or insurance companies promoted by entities which are associate of BRLMs or AIFs sponsored by the entities which are associate of the BRLMs or FPIs, other than individuals, corporate bodies and family offices sponsored by the entities which are associate of the and BRLMs) shall apply in the Offer under the Anchor Investor Portion.

- (k) Bids made by QIBs under both the Anchor Investor Portion and the QIB Portion will not be considered multiple Bids.

### **Bids by Systemically Important Non-Banking Financial Companies**

In case of Bids made by NBFC-SI registered with RBI, certified copies of: (i) the certificate of registration issued by RBI, (ii) certified copy of its last audited financial statements on a standalone basis, (iii) a net worth certificate from its statutory auditor, and (iv) such other approval as may be required by the NBFC-SI, are required to be attached to the Bid cum Application Form. Failing this, our Company and the Investor Selling Shareholders, in consultation with the BRLMs, reserves the right to reject any Bid without assigning any reason thereof, subject to applicable law. NBFC-SI participating in the Offer shall comply with all applicable regulations, guidelines and circulars issued by RBI from time to time.

The investment limit for NBFC-SI shall be as prescribed by RBI from time to time.

For more information, please read the General Information Document.

In accordance with existing regulations issued by the RBI, OCBs cannot participate in the Offer.

**The above information is given for the benefit of the Bidders. Our Company, the Selling Shareholders and the BRLMs are not liable for any amendments or modification or changes in applicable laws or regulations, which may occur after the date of this Draft Red Herring Prospectus. Bidders are advised to make their independent investigations and ensure that any single Bid from them does not exceed the applicable investment limits or maximum number of the Equity Shares that can be held by them under applicable law or regulation or as specified in this Draft Red Herring Prospectus, the Red Herring Prospectus and the Prospectus.**

### **Information for Bidders**

The relevant Designated Intermediary will enter a maximum of three Bids at different price levels opted in the Bid cum Application Form and such options are not considered as multiple Bids. It is the Bidder's responsibility to obtain the acknowledgment slip from the relevant Designated Intermediary. The registration of the Bid by the Designated Intermediary does not guarantee that the Equity Shares shall be allocated/Allotted. Such Acknowledgement Slip will be non-negotiable and by itself will not create any obligation of any kind. When a Bidder revises his or her Bid, he /she shall surrender the earlier Acknowledgement Slip and may request for a revised acknowledgment slip from the relevant Designated Intermediary as proof of his or her having revised the previous Bid. In relation to electronic registration of Bids, the permission given by the Stock Exchanges to use their network and software of the electronic bidding system should not in any way be deemed or construed to mean that the compliance with various statutory and other requirements by our Company, the Selling Shareholders and/or the Book Running Lead Managers are cleared or approved by the Stock Exchanges; nor does it in any manner warrant, certify or endorse the correctness or completeness of compliance with the statutory and other requirements, nor does it take any responsibility for the financial or other soundness of our Company, the management or any scheme or project of our Company; nor does it in any manner warrant, certify or endorse the correctness or completeness of any of the contents of the Red Herring Prospectus or the Red Herring Prospectus; nor does it warrant that the Equity Shares will be listed or will continue to be listed on the Stock Exchanges.

### **General Instructions**

Please note that QIBs and Non-Institutional Investors are not permitted to withdraw their Bid(s) or lower the size of their Bid(s) (in terms of quantity of Equity Shares or the Bid Amount) at any stage. RIIs can revise their Bid(s) during the Bid/Offer Period and withdraw or lower the size of their Bid(s) until Bid/Offer Closing Date. Anchor Investors are not allowed to withdraw their Bids after the Anchor Investor Bid/Offer Period.

#### ***Do's:***

1. Check if you are eligible to apply as per the terms of this Draft Red Herring Prospectus and under applicable law, rules, regulations, guidelines and approvals. All Bidders (other than Anchor Investors) should submit their Bids through the ASBA process only;
2. Ensure that you have Bid within the Price Band;
3. Read all the instructions carefully and complete the Bid cum Application Form, as the case may be, in

the prescribed form;

4. Ensure that you (other than the Anchor Investors) have mentioned the correct details of ASBA Account (i.e. bank account number or UPI ID, as applicable) and PAN in the Bid cum Application Form and if you are a UPI Bidder ensure that you have mentioned the correct UPI ID (with maximum length of 45 characters including the handle), in the Bid cum Application Form;
5. Ensure that your Bid cum Application Form bearing the stamp of a Designated Intermediary is submitted to the Designated Intermediary at the relevant Bidding Centre (except in case of electronic Bids) within the prescribed time;
6. UPI Bidders Bidding in the Offer shall ensure that they use only their own ASBA Account or only their own bank account linked UPI ID (only for UPI Bidders) to make an application in the Offer and not ASBA Account or bank account linked UPI ID of any third party;
7. Ensure that you have funds equal to the Bid Amount in the ASBA Account maintained with the SCSB before submitting the ASBA Form to the relevant Designated Intermediaries;
8. Ensure that you have accepted the UPI Mandate Request received from the Sponsor Bank prior to 12:00 pm of the Working Day immediately after the Bid/ Offer Closing Date;
9. Ensure that the signature of the first Bidder in case of joint Bids, is included in the Bid cum Application Forms. If the first Bidder is not the ASBA Account holder, ensure that the Bid cum Application Form is also signed by the ASBA Account holder;
10. Ensure that the names given in the Bid cum Application Form is/are exactly the same as the names in which the beneficiary account is held with the Depository Participant. In case of joint Bids, the Bid cum Application Form should contain the name of only the first Bidder whose name should also appear as the first holder of the beneficiary account held in joint names;
11. Ensure that you request for and receive a stamped acknowledgement in the form of a counterfoil of the Bid cum Application Form for all your Bid options from the concerned Designated Intermediary;
12. Ensure that you submit the revised Bids to the same Designated Intermediary, through whom the original Bid was placed and obtain a revised acknowledgment;
13. Except for Bids (i) on behalf of the Central or State Governments and the officials appointed by the courts, who, in terms of the circular no. MRD/DoP/Cir-20/2008 dated June 30, 2008 issued by SEBI, may be exempt from specifying their PAN for transacting in the securities market, (ii) Bids by persons resident in the state of Sikkim, who, in terms of the circular dated July 20, 2006 issued by SEBI, may be exempted from specifying their PAN for transacting in the securities market, and (iii) persons/entities exempt from holding a PAN under applicable law, all Bidders should mention their PAN allotted under the IT Act. The exemption for the Central or the State Government and officials appointed by the courts and for investors residing in the State of Sikkim is subject to (a) the Demographic Details received from the respective depositories confirming the exemption granted to the beneficial owner by a suitable description in the PAN field and the beneficiary account remaining in "active status"; and (b) in the case of residents of Sikkim, the address as per the Demographic Details evidencing the same. All other applications in which PAN is not mentioned will be rejected;
14. Ensure that thumb impressions and signatures other than in the languages specified in the Eighth Schedule to the Constitution of India are attested by a Magistrate or a Notary Public or a Special Executive Magistrate under official seal;
15. FPIs making MIM Bids using the same PAN, and different beneficiary account numbers, Client IDs and DP IDs, are required to submit a confirmation that their Bids are under the MIM structure and indicate the name of their investment managers in such confirmation which shall be submitted along with each of their Bid cum Application Forms. In the absence of such confirmation from the relevant FPIs, such MIM Bids shall be rejected;
16. Investors must ensure that their PAN is linked with Aadhaar and is in compliance with the Central Board of Direct Taxes notification dated February 13, 2020 bearing notification number 11/2020 and press release dated June 25, 2021.

17. Ensure that the category and the investor status is indicated in the Bid cum Application Form to ensure proper upload of your Bid in the electronic Bidding system of the Stock Exchanges;
18. Ensure that in case of Bids under power of attorney or by limited companies, corporates, trust, etc., relevant documents including a copy of the power of attorney, if applicable, are submitted;
19. Ensure that Bids submitted by any person outside India is in compliance with applicable foreign and Indian laws; Bids received from FPIs bearing the same PAN shall not be treated as multiple Bids in the event such FPIs utilise the MIM Structure and such Bids have been made with different beneficiary account numbers, Client IDs and DP IDs.
20. Since the Allotment will be in dematerialised form only, ensure that the depository account is active, the correct DP ID, Client ID, UPI ID (for UPI Bidders) and the PAN are mentioned in their Bid cum Application Form and that the name of the Bidder, the DP ID, Client ID, UPI ID (for UPI Bidders) and the PAN entered into the online IPO system of the Stock Exchanges by the relevant Designated Intermediary, as applicable, matches with the name, DP ID, Client ID, UPI ID (for UPI Bidders) and PAN available in the Depository database;
21. In case of QIBs and NIIs, ensure that while Bidding through a Designated Intermediary, the ASBA Form is submitted to a Designated Intermediary in a Bidding Centre and that the SCSB where the ASBA Account, as specified in the ASBA Form, is maintained has named at least one branch at that location for the Designated Intermediary to deposit ASBA Forms (a list of such branches is available on the website of SEBI at [http:// www.sebi.gov.in](http://www.sebi.gov.in));
22. Ensure that you have correctly signed the authorisation/undertaking box in the Bid cum Application Form, or have otherwise provided an authorisation to the SCSB or the Sponsor Bank, as applicable, via the electronic mode, for blocking funds in the ASBA Account equivalent to the Bid Amount mentioned in the Bid cum Application Form at the time of submission of the Bid. In case of UPI Bidders, ensure that you authorise the UPI Mandate Request raised by the Sponsor Bank for blocking of funds equivalent to Bid Amount and subsequent debit of funds in case of Allotment;
23. Ensure that the Demographic Details are updated, true and correct in all respects;
24. The ASBA Bidders shall use only their own bank account or only their own bank account linked UPI ID for the purposes of making Application in the Offer, which is UPI 2.0 certified by NPCI;
25. Bidders (except UPI Bidders) should instruct their respective banks to release the funds blocked in the ASBA account under the ASBA process. In case of UPI Bidders, once the Sponsor Bank issues the Mandate Request, the UPI Bidders would be required to proceed to authorise the blocking of funds by confirming or accepting the UPI Mandate Request to authorise the blocking of funds equivalent to application amount and subsequent debit of funds in case of Allotment, in a timely manner;
26. Bidding through UPI Mechanism shall ensure that details of the Bid are reviewed and verified by opening the attachment in the UPI Mandate Request and then proceed to authorise the UPI Mandate Request using their UPI PIN. Upon the authorisation of the mandate using their UPI PIN, a UPI Bidder shall be deemed to have verified the attachment containing the application details of the UPI Bidder in the UPI Mandate Request and have agreed to block the entire Bid Amount and authorised the Sponsor Bank issue a request to block the Bid Amount specified in the Bid cum Application Form in his/her ASBA Account;
27. UPI Bidders should mention valid UPI ID of only the Bidder (in case of single account) and of the first Bidder (in case of joint account) in the Bid cum Application Form;
28. UPI Bidders who have revised their Bids subsequent to making the initial Bid should also approve the revised UPI Mandate Request generated by the Sponsor Bank to authorise blocking of funds equivalent to the revised Bid Amount and subsequent debit of funds in case of Allotment in a timely manner.
29. Bids by Eligible NRIs HUFs and any individuals, corporate bodies and family offices which are re-categorised as Category II FPI and registered with SEBI for a Bid Amount of less than ₹200,000 would be considered under the Retail Category for the purposes of allocation and Bids for a Bid Amount exceeding ₹200,000 would be considered under the Non-Institutional Category for allocation in the Offer; and

30. Ensure that Anchor Investors submit their Bid cum Application Forms only to the BRLMs.

The Bid cum Application Form is liable to be rejected if the above instructions, as applicable, are not complied with. Application made using incorrect UPI handle or using a bank account of an SCSB or SCSBs which is not mentioned in the Annexure 'A' to the SEBI circular no. SEBI/HO/CFD/DIL2/CIR/P/2019/85 dated July 26, 2019 is liable to be rejected.

***Don'ts:***

1. Do not Bid for lower than the minimum Bid Lot;
2. Do not submit a Bid using UPI ID, if you are not a UPI Bidder;
3. Do not Bid for a Bid Amount exceeding ₹200,000 for Bids by Retail Individual Investors;
4. Do not Bid on another Bid cum Application Form and the Anchor Investor Application Form, as the case may be, after you have submitted a Bid to any of the Designated Intermediary;
5. Do not Bid/revise the Bid amount to less than the floor price or higher than the cap price;
6. Do not pay the Bid Amount in cheques, demand drafts or by cash, money order, postal order or by stock invest;
7. Do not send Bid cum Application Forms by post; instead submit the same to the Designated Intermediary only;
8. Do not Bid at Cut-off Price (for Bids by QIBs and Non-Institutional Investors);
9. Do not instruct your respective banks to release the funds blocked in the ASBA Account under the ASBA process;
10. Do not submit the Bid for an amount more than funds available in your ASBA account;
11. Do not submit Bids on plain paper or on incomplete or illegible Bid cum Application Forms or on Bid cum Application Forms in a colour prescribed for another category of Bidder;
12. Do not submit a Bid in case you are not eligible to acquire Equity Shares under applicable law or your relevant constitutional documents or otherwise;
13. Do not Bid if you are not competent to contract under the Indian Contract Act, 1872 (other than minors having valid depository accounts as per Demographic Details provided by the depository);
14. Do not fill up the Bid cum Application Form such that the Equity Shares Bid for exceeds the Offer size and/or investment limit or maximum number of the Equity Shares that can be held under the applicable laws or regulations or maximum amount permissible under the applicable regulations or under the terms of this Draft Red Herring Prospectus;
15. Do not Bid for Equity Shares more than specified by the respective Stock Exchanges for each category;
16. In case of ASBA Bidders (other than UPI Bidders), do not submit more than one Bid cum Application Form per ASBA Account;
17. If you are a UPI Bidder, do not submit more than one Bid cum Application Form for each UPI ID;
18. Do not make the Bid cum Application Form using third party bank account or using third party linked bank account UPI ID;
19. Anchor Investors should not bid through the ASBA process;
20. Do not submit the Bid cum Application Form to any non-SCSB bank or our Company;
21. Do not Bid on another Bid cum Application Form and the Anchor Investor Application Form, as the case may be, after you have submitted a Bid to any of the Designated Intermediaries;



22. Do not submit the GIR number instead of the PAN;
23. Anchor Investors should submit Anchor Investor Application Form only to the BRLMs;
24. Do not Bid on a Bid cum Application Form that does not have the stamp of a Designated Intermediary;
25. If you are a QIB, do not submit your Bid after 3 p.m. on the QIB Bid/Offer Closing Date;
26. Do not withdraw your Bid or lower the size of your Bid (in terms of quantity of the Equity Shares or the Bid Amount) at any stage, if you are a QIB or a Non-Institutional Investor. Retail Individual Investors can revise or withdraw their Bids on or before the Bid/Offer Closing Date;
27. Do not submit Bids to a Designated Intermediary at a location other than at the relevant Bidding Centres. If you are a UPI Bidder, do not submit the ASBA Form directly with SCSBs;
28. Do not submit incorrect details of the DP ID, Client ID, PAN and UPI ID details if you are a UPI Bidder. Further, do not provide details for a beneficiary account which is suspended or for which details cannot be verified to the Registrar to the Offer;
29. Do not submit the Bid without ensuring that funds equivalent to the entire Bid Amount are available for blocking in the relevant ASBA account;
30. Do not link the UPI ID with a bank account maintained with a bank that is not UPI 2.0 certified by the NPCI in case of Bids submitted by UPI Bidders;
31. UPI Bidders using the incorrect UPI handle or using a bank account of an SCSB or a banks which is not mentioned in the list provided in the SEBI website is liable to be rejected; and
32. Do not submit more than one Bid cum Application Form for each UPI ID in case of UPI Bidders.

**The Bid cum Application Form is liable to be rejected if the above instructions, as applicable, are not complied with.**

For helpline details of the BRLMs pursuant to the SEBI/HO.CFD.DIL2/CIR/P/2021/2480/1/M dated March 16, 2021, see “*General Information – Book Running Lead Managers*” on page 79.

Further, in case of any pre-Offer or post Offer related issues regarding share certificates/demat credit/refund orders/unblocking etc., investors shall reach out the Company Secretary and Compliance Officer. For details of the Company Secretary and Compliance Officer, see “*General Information – Company Secretary and Compliance Officer*” on page 79.

For details of grounds for technical rejections of a Bid cum Application Form, please see the General Information Document.

#### **Names of entities responsible for finalising the basis of allotment in a fair and proper manner**

The authorised employees of the Stock Exchanges, along with the BRLMs and the Registrar to the Offer, shall ensure that the Basis of Allotment is finalised in a fair and proper manner in accordance with the procedure specified in SEBI ICDR Regulations.

#### **Method of allotment as may be prescribed by SEBI from time to time**

Our Company will not make any Allotment in excess of the Equity Shares offered through the Offer through the Offer document except in case of oversubscription for the purpose of rounding off to make Allotment, in consultation with the Designated Stock Exchange. Further, upon oversubscription, an Allotment of not more than 1% of the Offer to public may be made for the purpose of making Allotment in minimum lots.

The Allotment of Equity Shares to Bidders other than to the RIIs, NIIs and Anchor Investors shall be on a proportionate basis within the respective investor categories and the number of securities Allotted shall be rounded off to the nearest integer, subject to minimum Allotment being equal to the minimum application size as determined and disclosed. The allotment of specified securities to each NII shall not be less than the minimum application size, subject to availability in the Non-Institutional Category, and the remainder, if any, shall be allotted on a proportionate basis in accordance with the conditions specified in the SEBI ICDR Regulations.

The Allotment of Equity Shares to each RII shall not be less than the minimum Bid lot, subject to the availability of shares in RII category, and the remaining available shares, if any, shall be allotted on a proportionate basis.

### **Payment into Anchor Investor Escrow Account**

Our Company and the Investor Selling Shareholders, in consultation with the BRLMs, will decide the list of Anchor Investors to whom the CAN will be sent, pursuant to which, the details of the Equity Shares allocated to them in their respective names will be notified to such Anchor Investors. For Anchor Investors, the payment instruments for payment into the Anchor Investor Escrow Account should be drawn in favour of:

- (a) In case of resident Anchor Investors: “[●]”
- (b) In case of Non-Resident Anchor Investors: “[●]”

Anchor Investors should note that the escrow mechanism is not prescribed by SEBI and has been established as an arrangement between our Company, the Selling Shareholders, the Syndicate, the Escrow Collection Bank and the Registrar to the Offer to facilitate collections of Bid amounts from Anchor Investors.

### **Pre-Offer Advertisement**

Subject to Section 30 of the Companies Act, 2013, our Company shall, after filing the Red Herring Prospectus with the RoC, publish a pre-Offer advertisement, in the form prescribed under the SEBI ICDR Regulations, in all editions of [●] (a widely circulated English national daily newspaper) and all editions of [●] (a widely circulated Hindi national daily newspaper, Hindi also being the regional language of New Delhi, where our Registered Office is located). In the pre-Offer advertisement, our Company shall state the Bid/Offer Opening Date and the Bid/Offer Closing Date. This advertisement, subject to the provisions of Section 30 of the Companies Act, 2013, shall be in the format prescribed in part A of Schedule X of the SEBI ICDR Regulations.

**The information set out above is given for the benefit of the Bidders/applicants. Our Company, the Selling Shareholders, and the BRLMs are not liable for any amendments or modification or changes in applicable laws or regulations, which may occur after the date of this Draft Red Herring Prospectus. Bidders/applicants are advised to make their independent investigations and ensure that the number of Equity Shares Bid for do not exceed the prescribed limits under applicable laws or regulations.**

### **Allotment Advertisement**

Our Company, the BRLMs and the Registrar shall publish an allotment advertisement before commencement of trading, disclosing the date of commencement of trading in all editions of [●] (a widely circulated English national daily newspaper) and all editions of [●] (a widely circulated Hindi national daily newspaper, Hindi also being the regional language of New Delhi, where our Registered Office is located).

### **Signing of the Underwriting Agreement and filing with the RoC**

Our Company and the Selling Shareholders intend to enter into an Underwriting Agreement after the finalisation of the Offer Price. After signing the Underwriting Agreement, our Company will file the Prospectus with the RoC. The Prospectus will contain details of the Offer Price, the Anchor Investor Offer Price, the Offer size, and underwriting arrangements and will be complete in all material respects.

### **Impersonation**

Attention of the applicants is specifically drawn to the provisions of sub-section (1) of Section 38 of the Companies Act, 2013, which is reproduced below:

“Any person who:

- (a) *makes or abets making of an application in a fictitious name to a company for acquiring, or subscribing for, its securities; or*
- (b) *makes or abets making of multiple applications to a company in different names or in different combinations of his name or surname for acquiring or subscribing for its securities; or*
- (c) *otherwise induces directly or indirectly a company to allot, or register any transfer of, securities to him, or to any other person in a fictitious name,*

*shall be liable for action under Section 447.”*

The liability prescribed under Section 447 of the Companies Act, 2013, for fraud involving an amount of at least ₹1 million or 1% of the turnover of the Company, whichever is lower, includes imprisonment for a term which shall not be less than six months extending up to 10 years and fine of an amount not less than the amount involved in the fraud, extending up to three times such amount (provided that where the fraud involves public interest, such term shall not be less than three years.) Further, where the fraud involves an amount less than ₹1 million or one per cent of the turnover of the company, whichever is lower, and does not involve public interest, any person guilty of such fraud shall be punishable with imprisonment for a term which may extend to five years or with fine which may extend to ₹5 million or with both.

### **Undertakings by our Company**

Our Company undertakes the following:

- the complaints received in respect of the Offer shall be attended to by our Company expeditiously and satisfactorily;
- if Allotment is not made within the prescribed timelines under applicable laws, the application monies will be refunded/unblocked within the time prescribed under applicable laws. If there is a delay beyond such prescribed time, our Company shall pay interest prescribed under the Companies Act, 2013, the SEBI ICDR Regulations and other applicable laws for the delayed period;
- all steps will be taken for completion of the necessary formalities for listing and commencement of trading at all the Stock Exchanges where the Equity Shares are proposed to be listed are taken within such period as may be prescribed under applicable law;
- the funds required for making refunds/unblocking (to the extent applicable) as per the mode(s) disclosed shall be made available to the Registrar to the Offer by our Company;
- where refunds (to the extent applicable) are made through electronic transfer of funds, a suitable communication shall be sent to the Bidder within time prescribed under applicable laws, giving details of the bank where refunds shall be credited along with amount and expected date of electronic credit of refund;
- Promoters' contribution, if any, shall be brought in advance before the Bid/Offer Opening Date and the balance, if any, shall be brought in on a pro rata basis before calls are made on the Allottees;
- no further issue of the Equity Shares shall be made till the Equity Shares offered through the Red Herring Prospectus are listed or until the Bid monies are refunded/unblocked in the relevant ASBA Accounts on account of non-listing, undersubscription, etc. and
- adequate arrangements shall be made to collect all Bid cum Application Forms from Bidders.

### **Undertakings by the Selling Shareholders**

Each of the Selling Shareholder, severally and not jointly, specifically undertakes and/or confirms the following in respect to itself as a Selling Shareholder and its respective portion of the Offered Shares:

- (i) it is the legal and beneficial holder and has full title to its respective portion of the Offered Shares;
- (ii) its respective portion of the Offered Shares shall be transferred pursuant to the Offer, free and clear of any encumbrances;
- (iii) it shall not offer any incentive, whether direct or indirect, in any manner, whether in cash or kind or services or otherwise to any Bidder for making a Bid in the Offer; and
- (iv) it shall not have recourse to the proceeds from the Offer for Sale until receipt by our Company of the final listing and trading approvals from all the Stock Exchanges.

### **Utilisation of Offer Proceeds**

Our Board, specifically confirms that all monies received out of the Offer shall be credited/transferred to a separate bank account other than the bank account referred to in sub-section (3) of Section 40 of the Companies Act, 2013.

## RESTRICTIONS ON FOREIGN OWNERSHIP OF INDIAN SECURITIES

Foreign investment in Indian securities is regulated through the Industrial Policy, 1991 of the Government of India and FEMA. While the Industrial Policy, 1991 prescribes the limits and the conditions subject to which foreign investment can be made in different sectors of the Indian economy, FEMA regulates the precise manner in which such investment may be made. Foreign investment is permitted (except in the prohibited sectors) in Indian companies, either through the automatic route or the approval route, depending upon the sector in which foreign investment is sought to be made.

The Government of India makes policy announcements on FDI through press notes and press releases. The regulatory framework, over a period of time, thus, consists of acts, regulations, press notes, press releases, and clarifications among other amendments. The DPIIT (formerly Department of Industrial Policy & Promotion) issued the Consolidated FDI Policy Circular dated October 15, 2020, with effect from October 15, 2020 (the “**FDI Circular**”), which consolidates and supersedes all previous press note, press releases and clarifications on FDI issued by the DPIIT that were in force and effect prior to October 15, 2020. The transfer of shares between an Indian resident and a non-resident does not require the prior approval of the RBI, provided that (i) the activities of the investee company are under the automatic route under the FDI Circular and transfer does not attract the provisions of the SEBI Takeover Regulations; (ii) the non-resident shareholding is within the sectoral limits under the FDI Circular; and (iii) the pricing is in accordance with the guidelines prescribed by the SEBI/RBI. The RBI and the concerned ministry/ department are responsible for granting the approval for foreign investment under the FDI Circular and FEMA.

All investments under the foreign direct investment route by entities of a country which shares land border with India or where the beneficial owner of an investment into India is situated in or is a citizen of any such country will require prior approval of the Government of India. Further, in the event of transfer of ownership of any existing or future foreign direct investment in an entity in India, directly or indirectly, resulting in the beneficial ownership falling within the aforesaid restriction/purview, such subsequent change in the beneficial ownership will also require approval of the Government of India.

For details of the aggregate limit for investments by NRIs and FPIs in our Company, see “*Offer Procedure – Bids by Eligible NRIs*” and “*Offer Procedure – Bids by FPIs*” on pages 422 and 422.

As per the existing policy of the Government of India, OCBs cannot participate in this Offer.

**The above information is given for the benefit of the Bidders. Our Company, the Selling Shareholders and the BRLMs are not liable for any amendments or modification or changes in applicable laws or regulations, which may occur after the date of this Draft Red Herring Prospectus. Bidders are advised to make their independent investigations and ensure that the number of Equity Shares Bid for do not exceed the applicable limits under laws or regulations.**

**The Equity Shares offered in the Offer have not been and will not be registered under the U.S. Securities Act or any state securities laws in the United States, and may not be offered or sold within the United States, except pursuant to an exemption from, or in a transaction not subject to, the registration requirements of the U.S. Securities Act and applicable state securities laws in the United States. Accordingly, the Equity Shares are being offered and sold outside the United States in offshore transactions in compliance with Regulation S and the applicable laws of the jurisdiction where those offers and sales are made.**

**The Equity Shares have not been and will not be registered, listed or otherwise qualified in any other jurisdiction outside India and may not be offered or sold, and Bids may not be made by persons in any such jurisdiction, except in compliance with the applicable laws of such jurisdiction.**

## **SECTION VIII - MAIN PROVISIONS OF THE ARTICLES OF ASSOCIATION**

The Articles of Association of the Company consist of two parts, Part I and Part II. The provisions of Part I shall apply to all the matters to which they pertain, to the extent, and only in so far, as they are not inconsistent with the provisions of Part II. Until the listing and commencement of trading of equity shares of the Company on a recognized stock exchange pursuant to the Offer, the provisions of Part II shall be applicable. However, on and from the date of listing and commencement of trading of the equity shares of the Company pursuant to the Offer, Part II shall automatically stand terminated, not have any force and be deemed to be removed from the Articles of Association and the provisions of Part I shall come into effect and be in force, without any further corporate or other action by the Company or its shareholders, unless specified otherwise in the Articles of Association. As long as Part II remains a part of the Articles of Association, in the event of any conflict or inconsistency, the provisions of Part II shall prevail over the provisions of Part I to the maximum extent permitted under the Act.

Capitalized terms used in this section have the meanings that have been given to such terms in the Articles of Association of the Company. Pursuant to Schedule I of the Companies Act and the SEBI ICDR Regulations, the main provisions of the Articles of Association of our Company are detailed below:

### **PART I**

#### **Share Capital**

The authorised share capital of the Company shall be such as given in clause V of the Memorandum of Association or as altered from time to time, thereat payable in the manner as may be determined by the Board, with the power to increase, reduce, sub-divide or to repay the same or to divide the same into several classes and to attach thereto any rights and to consolidate or sub-divide or re-organize the shares and subject to the provisions of the Companies Act, to vary such rights as may be determined in accordance with the regulations of the Company.

#### **Allotment of Shares**

Subject to the provisions of the Companies Act and the Articles of Association, the shares in the capital of the Company for the time being shall be under the control of the Board who may issue, allot or otherwise dispose of the same or any of them to such persons, in such proportion and on such terms and conditions and either at a premium or at par or (subject to the compliance with the provisions of sections 53 and 54 of the Companies Act) at a discount and at such time as they may from time to time think fit and with the sanction of the Company in the general meeting to give to any person or persons the option or right to call for any shares either at par or premium during such time and for such consideration as the Board think fit, and may issue and allot shares in the capital of the Company on payment in full or part of any property sold and transferred or for any services rendered to the Company in the conduct of its business and any shares which may so be allotted may be issued as fully paid up shares and if so issued, shall be deemed to be fully paid shares. Provided that option or right to call of shares shall not be given to any person or persons without the sanction of the Company in the general meeting. As regards all allotments, from time to time made, the Board shall duly comply with sections 23 and 39 of the Companies Act, as the case may be.

#### **Further Issue of Shares**

Where at any time, in terms of the provisions of the Companies Act, the Company proposes to increase the subscribed capital of the Company by issue and allotment of further shares either out of the unissued capital or out of the increased share capital, such shares shall be offered:

- a) To the persons who at the date of the offer, are holders of the equity shares of the Company, in proportion, as nearly as circumstances admit, to the capital paid up on those shares at that date by sending a letter of offer, subject to the following conditions:
  - (i) Such offer shall be made by a notice specifying the number of shares offered and limiting a time not being less than 15 (fifteen) days and not exceeding 30 (thirty) days from the date of offer within which the offer, if not accepted, will be deemed to have been declined. Provided that the notice shall be dispatched through registered post or speed post or through electronic mode or courier or any other mode having proof of delivery to all the existing shareholders at least three days before the opening of the issue

- (ii) The aforesaid offer shall be deemed to include a right exercisable by the person concerned to renounce the shares offered to him or any one of them in favour of any other person and the notice referred to in the article above shall contain a statement of this right. Nothing in this article shall be deemed to extend the time within which the offer should be accepted; or to authorize any person to exercise the right of renunciation for a second time on the ground that the person in whose favour the renunciation was first made has declined to take the shares comprised in the renunciation.

Provided that the Board may decline, without assigning any reason to allot any shares to any person in whose favour any member may renounce the shares offered to him.

- (iii) After the expiry of the time specified in the notice aforesaid or on receipt of earlier intimation from the person to whom such notice is given that he declines to accept the shares offered, the Board may dispose of them in such manner as it thinks most beneficial to the Company.

- b) To employees under a scheme of employees' stock option, subject to a special resolution passed by the Company and subject to the conditions in the Companies Act and other applicable law.
- c) To any persons, if authorized by a special resolution, whether those persons include the persons referred to in sub-clause (a) or sub-clause (b) hereof, either for cash or for a consideration other than cash, subject to compliance with the applicable laws.

Nothing contained in this Article shall apply to the increase of the subscribed capital of the Company caused by the exercise of an option as a term attached to the debentures issued or loans raised by the Company to convert such debentures or loans into shares in the Company.

Provided that the terms of issue of such debentures or the terms of such loans containing an option have been approved before the issue of such debentures or the raising of loan by a special resolution passed by the Company in the general meeting.

### **Certificate**

If any certificate of any shares or shares be surrendered to the Company for sub-division or consolidation or if any certificate be defaced, mutilated, torn or old, decrepit, worn-out or where the pages on the reverse for recording transfer have been duly utilized, or where there is no further space on the back thereof for endorsement of transfer then upon production and surrender thereof to the Company, the Board may order the same to be cancelled and may issue new certificate in lieu thereof and if any certificate be lost or destroyed then upon proof thereof to the satisfaction of the Company and on such indemnity as the Company think adequate being given a new certificate in lieu thereof shall be given to a party entitled to the shares of such lost or destroyed certificate relates. Where a new certificate has been issued, it shall state on the face of it and against the stub or counterfoil that it is issued in lieu of a share certificate or is a duplicate issued for the one so replaced and, in the case, certificate issued in place of one which has been lost or destroyed the word 'duplicate' shall be stamped or punched in bold letters across the face thereof. Every certificate under the Articles of Association shall be issued on payment of fees of ₹20 for each certificate as may be fixed by the Board and as per the applicable law.

No fee shall be charged for sub-division and consolidation of share / debenture certificates and for sub-division of letters of allotment, split and consolidation. Renewal and transfer receipts into denominations corresponding to the market units of trading, for sub-division of renounceable letters of rights. Provided that the Company may charge such fees as may be agreed by it with the stock exchange with which its shares may be listed for the time being for issue of new certificate in replacement of those that are torn defaced, lost or destroyed and for sub-division and consolidation of share and debenture certificates and for sub-division of letter of allotment and split consolidation, renewal and transfer receipts into denominations other than those fixed for the market units of trading.

### **Transfer and Transmission of Shares**

The instrument of transfer shall be in writing and all the provisions of section 56 of the Companies Act and

of any statutory modification thereof for the time being shall be duly complied with in respect of all transfer of shares and the registration thereof. A common form of transfer shall be used.

#### Execution of transfer

Subject to the provisions of the Companies Act and the Articles of Association, no transfer of shares shall be registered unless a proper instrument of transfer duly stamped and executed by or on behalf of the transferor or transferee has been delivered to the Company within a period of 60 (sixty) days from the date of the execution together with the certificate or certificates of the shares or if no such certificate is in existence along with the letter of allotment of shares. The instrument of transfer of any shares shall be signed both by or on behalf of the transferor and by or on behalf of the transferee and the transferor shall be deemed to remain the holder of such share until the name of the transferee is entered in the register in respect thereof.

#### Application for transfer

Application for the registration of the transfer of a share may be made either by the transferor or the transferee provided that where such application is made by the transferor, no registration shall in the case of partly paid shares be effected unless the Company gives notice of the application to the transferee in the manner prescribed by the Companies Act, and subject to the Articles of Association, the Company shall unless objection is made by the transferee within two weeks from the date of receipt of the notice enter in the register the name of the transferee in the same manner and subject to the same conditions as if the application for registration was made by the transferee.

#### Notice of transfer to registered holder

Before registering any transfer tender for registration, the Company, may if it thinks fit give notice by letter posted in the ordinary course to the registered holder that such transfer deed has been lodged and that unless objection is taken, the transfer will be registered and if such registered holder fails to lodge an objection in writing at the Office of the Company within two weeks from the posting of such notice to him he shall be deemed to have admitted the validity of the said transfer.

#### Register of transfers

The Company shall keep a 'register of transfer' and therein shall have recorded fairly and distinctly particulars of every transfer or transmission of any share, debenture or other securities held in a material form.

#### Decline to register transfer of shares

Subject to the provisions of sections 58 and 59 of the Companies Act, section 22A of the SCRA, any listing agreement entered into with any recognized stock exchange and other applicable provisions of the Companies Act or any other applicable law for the time being in force as amended, the Board may, whether in pursuance of any power of the Company under the Articles of Association or otherwise refuse to register the transfer of, or the transmission by operation of applicable law of the right to, any securities or interest of a shareholder in the Company. The Company shall, within 30 (thirty) days from the date on which the instrument of transfer, or the intimation of such transmission, as the case may be, was delivered to the Company, send a notice of refusal to the transferee and transferor or to the person giving notice of such transmission, as the case may be, giving reasons for such refusal. However, no transfer of shares/debentures shall be refused on the ground of them not being held in marketable lots.

No transfer shall be made to a minor or a person of unsound mind.

#### No fee for registration for transfer

No fee shall be charged for registration for transfer, transmission, probate, succession certificate, grant, letter of administration, succession certificate, certificate of death or marriage, power of attorney or similar other documents.

#### When instrument of transfer to be retained



All instruments of transfer duly approved shall be retained by the Company and in case of refusal, instruments of transfer shall be returned to the person who lodged the transfer deeds.

#### Power to close transfer book & register

Subject to the provisions of the Companies Act, the register of members may be closed for any period or periods not exceeding in the aggregate forty-five days in each year, but not exceeding thirty days at any one time, subject to giving of previous notice of at least seven days or such lesser period as may be specified by SEBI for listed companies or the companies which intend to get their securities listed.

#### Transmission of registered shares

The executors or administrators or nominees or legal representatives or the holder of succession certificate in respect of shares of a deceased member (not being one of several joint holders) shall be the only person whom the Company shall recognize as having any title to the shares registered in the name of such member and, in case of the death of any one or more of the joint- holders of any registered shares the survivors shall be only persons recognized by the Company as having any title to or interest in such share but nothing contained in this article shall be taken to release the estate of a deceased joint- holder from any liability on shares held by him jointly with any other person. Before recognizing any legal representative or heir or a person otherwise claiming title to the shares the Company may require him to obtain a grant of probate or letters of administration or succession certificate or other legal representation as the case may be from a competent court, provided nevertheless that in any case where the Board in its absolute discretion think fit, it shall be lawful for the Board to dispense with production of the probate or letter of administration or a succession certificate or such other legal representation upon such terms as to indemnity or otherwise as the Board may consider desirable.

#### Transfer of shares deceased or insolvent members

Any person becoming entitled to transfer shares in consequence of the death or insolvency of any member, upon producing such evidence that he sustains the character in respect of which he proposes to act under this article, or of his title as the Board think sufficient, may with the consent of the Board (which they shall not be under any obligation to give), be registered as a member in respect of such shares or may, subject to the regulations as to transfer hereinbefore contained, transfer such shares as the deceased or insolvent person could have transferred.

#### Rights to executors and trustees

Subject to any other provisions of the Articles of Association, if the Board in its sole direction is satisfied in regard thereof, a person becoming entitled to a share in consequence of the death or insolvency of a member may receive and give a discharge for any dividends or other money payable in respect of the share

#### **Calls**

The Board may from time to time, subject to the provisions of the Companies Act and the terms on which any shares may have been issued make such calls as it thinks fit upon the members in respect of all monies unpaid on the shares held by them respectively, and not by the conditions of allotment thereto made payable at fixed times, and each member shall pay the amount of every call so made on him to the persons and at the times and places appointed by the Board. Provided that no call shall exceed one-fourth of the nominal value of the share or be payable at less than one month from the date fixed for the payment of the last preceding call. A call may be made payable by instalments.

#### When call deemed to have been made

That the option or right to call of shares shall not be given to any person except with the sanction of the Company in a general meeting.

A call shall be deemed to have been made at the time when the resolution of the Board authorizing the call was passed.

#### Notice to call

Not less than 30 (thirty) days' notice of any call shall be given specifying the time and place of payment and to whom such call shall be paid.

#### Amount payable

If the terms of issue of any share or otherwise, the whole or part of the amount of issue price thereof is made payable at any fixed time or by instalments at fixed times, every such amount of issue price or instalment thereof shall be payable as if it was a call duly made by the Board and of which due notice had been given and all the provisions herein contained in respect of calls shall apply to such amount of issue price or instalments accordingly.

#### Interest to be charged on non-payment of calls

If the sum payable in respect of any call or instalment be not paid on or before the day appointed for the payment thereof the holder for the time being of the share in respect of which the call shall have been made or the instalment shall be due, shall pay interest for the same at the rate of 10 (ten) percent per annum, from the day appointed for the payment thereof to the actual payment in accordance with the applicable law or at such other lower rate as the Board may determine but they shall have the power to waive the payment thereof wholly or in part. Provided that moneys paid in advance of calls shall not in respect thereof confer a right to dividend or to participate in the profits of the Company.

#### Evidence in actions by Company against shareholders

On the trial, at hearing of any action or suit brought by the Company against any member or his representative to recover any debt or money claimed to be due to the Company in respect of his shares, it shall be sufficient to prove that the name of the defendant is, or was when the claim arose, on the register of the Company as a holder, or one of the holders of the number of shares in respect of which such claim is made, that the resolution making the call is duly recorded in the minute book and that the amount claimed is not entered as paid in the books of the Company, and it shall not be necessary to prove the appointment of the directors who made any call or that a quorum of directors was present at the meeting at which any call was made or that such meeting was duly convened or constituted, or any other matter whatsoever, but the proof of such matters shall be conclusive evidence of the debts.

#### Payment of calls in advance

The Board may, if it thinks fit, subject to the provisions of section 50 of the Companies Act, agree to and receive from any member willing to advance the same, all or any part of the money due upon the shares held by him beyond the sums actually called for and upon the amount so paid or satisfied in advance or so much thereof as from time to time exceeds the amount of calls then made, upon the shares in respect of which such advance has been made, the Company may pay interest at such rate not exceeding, unless the Company in general meeting shall otherwise direct, 12 (twelve) percent per annum to the member paying such sum as advance and the Board agrees upon money so paid in excess of amount of call shall not rank for dividends or confer a right to participate in profits. The Board may at any time repay the amount so advanced upon giving such member notice in writing.

The members shall not be entitled to any voting rights in respect of the money so paid by them until the same would but for such payment, become presently payable.

Neither a judgment nor a decree in favour of the Company for calls or other monies due in respect of any share, nor any part payment or satisfaction thereunder, nor the receipt by the Company of a portion of any money which shall from, time to time, be due from any member in respect of any share, either by way of principal or interest nor any indulgency granted by the Company in respect of the payment of any such money shall preclude the Company from thereafter proceeding to enforce a forfeiture of such shares as herein after provided The provisions of the Articles of Association shall mutatis mutandis apply to the calls on debentures of the Company.

#### **Forfeiture and Lien**

#### Notice may be given for calls or installment not paid

If a member fails to pay any call, or instalment on or before the day appointed for the payment of the same, the Board may at any time thereafter, during such time as the call or instalment remain unpaid, serve notice on such member requiring him to pay the same together with any interest that may have accrued and expenses that may have been incurred by the Company by reasons of such non-payment.

#### Form of notice

The notice shall name a further day (not being earlier than the expiry of 14 (fourteen) days from the date of service of the notice) and a place or places on and at which such call or instalment and such interest and expenses as aforesaid are to be paid. The notice shall also state that in the event of non-payment on or before the time, and at the place or places appointed, the shares in respect of which such call was made or instalment is payable will be liable to be forfeited.

#### If notice not complied with shares may be forfeited

If the requirement of any such notice as aforesaid to be not complied with, any shares in respect of which such notice has been given may, at any time thereafter before payment of all calls or instalments, interest and expenses due in respect thereof, be forfeited by a resolution of the Board to that effect. Such forfeiture shall include all dividends declared in respect of the forfeited shares not actually paid before the forfeiture. Subject to section 123 of the Companies Act, neither the receipt by the Company of a portion of any money which shall, from time to time, be due from any member of the Company in respect of his shares, either by way of principal or interest, nor any indulgency granted by the Company in respect of the payment of any such money shall preclude the Company from thereafter proceeding to enforce a forfeiture of such share as herein provided.

#### Notice after forfeiture

When any shares shall have been so forfeited, notice of the forfeiture shall be given to the member in whose name it stood immediately prior to the forfeiture, and an entry of the forfeiture with the date thereof, shall forthwith be made in the register but no forfeiture shall be in any manner invalidated by any omission or neglect to give such notice or to make such entry.

#### Forfeited shares to become property of the Company

Any share so forfeited shall be deemed to be the property of the Company and the Board may sell, re-allot or otherwise dispose of the same in such manner as they think fit.

#### Power to annul forfeiture

The Board may, at any time before any share so forfeited shall be sold, re-allotted or otherwise disposed of annul the forfeiture thereof upon such conditions as they think fit.

#### Arrears to be paid notwithstanding forfeiture

A person whose shares have been forfeited shall cease to be a member in respect of the forfeited shares, but shall, notwithstanding the forfeiture, remain liable to pay to the Company all moneys, which, at the date of the forfeiture, were presently payable by him to the Company in respect of the shares. The liability of such person shall cease if the Company receives payment in full of all such monies in respect of the shares.

#### Effect of forfeiture

The forfeiture of a share shall involve the extinction of all interest in and also of all claims and demands against the Company in respect of the share, and all other rights incidental to the share, except only such of those rights as by the Articles of Association are expressly saved.

#### Evidence of forfeiture

A duly verified declaration in writing that the declarant is a director, the manager or the secretary of the Company and that certain shares in the Company have been duly forfeited on a date stated in the declaration shall be conclusive evidence of the facts therein stated as against all persons claiming to be entitled to the shares and the receipt of the Company for the consideration, if any, given for the shares on the sale or disposition thereof, shall constitute a written title to such share.

#### Company lien on shares and debentures

The Company shall have a first and paramount lien upon all the shares/debentures registered in the name of such member (whether solely or jointly) with others and upon the proceeds of sale thereof for all moneys (whether presently payable or not) called or payable at a fixed time in respect of such shares/debentures and no equitable interest in any shares shall be created except on the footing and condition that this article will have full effect. That fully paid shares/debentures shall be free from all lien and that in the case of partly paid shares, the Company's lien shall be restricted to money called or payable at a fixed time in respect of such shares. Such lien shall extend to all dividends and bonuses from time to time declared in respect of such shares/debentures. Unless otherwise agreed, the registration of a transfer of shares/debentures shall operate as a waiver of the Company's lien, if any, on such shares/debentures. The Board may at any time declare any shares/debentures wholly or in part to be exempt from the provision of this clause.

#### Intention as to enforcing lien by sale, application of proceeds of sale

For the purpose of enforcing such lien, the Board may sell the shares subject thereto in such manner as they think fit, but no sale shall be made until such period as aforesaid shall have elapsed and until notice in writing of the intention to sell shall have been served on such member, his committee, *curator bonis* or other person recognized by the Company as entitled to represent such member and default shall have been made by him or them in the payment of the sum payable as aforesaid for 30 (thirty) days after such notice. The net proceeds of any such sale shall be applied in or towards satisfaction of such part of the amount in respect of which the lien exists as is presently payable by such member and the residue (if any) be paid to such member, his executors, administrator, or other representatives or persons so recognized as aforesaid.

#### Validity of shares

Upon any sale after forfeiture or for enforcing a lien in purported exercise of the powers by these presents given the Board may appoint some person to execute an instrument of transfer of the shares sold and cause the purchaser's name to be entered in the register in respect of the shares sold and after his name has been entered in the register in respect of such shares his title to such shares shall not be affected by any irregularity or invalidity in the proceedings in reference to such forfeiture, sale or disposition, nor impeached by any person and the remedy of any person aggrieved by the sale shall be in damages only and against the Company exclusively. The proceeds of the sale shall be received by the Company and applied in payment of such part of the amount in respect of which the lien exists as is presently payable. The residue, if any, shall, subject to a like lien for sums not presently payable as existed upon the shares before the sale, be paid to the person entitled to the shares at the date of the sale.

#### Power to issue new certificate

Where any shares under the powers in that behalf herein contained are sold by the Board and the certificate thereof has not been delivered to the Company by the former holders of the said shares the Board may issue new certificate in lieu of certificate not so delivered up.

#### General Meetings

All general meetings of the Company other than the Annual General Meeting shall be called an extra ordinary general meeting.

#### Extra-ordinary general meeting

The Board may, whenever they think fit, call an extra ordinary general meeting. If at any time Directors capable of acting who are sufficient in number to form a quorum are not within India, any Director or any two members of the Company may call an extraordinary general meeting in the same manner, as nearly as possible, as that in which such a meeting may be called by the Board.

#### Calling of extra-ordinary general meeting on requisition

The Board of the Company shall on the requisition of such member or members of the Company as is specified in sub section (2) of section 100 of the Companies Act forthwith proceed to call an extra-ordinary general meeting of the Company and in respect of any such requisition and of any meeting to be called pursuant thereto, all the other provisions of section 100 of the Companies Act and of any statutory modification thereof for the time being shall apply.

#### Quorum

The quorum for a general meeting shall be as provided in section 103 of the Companies Act.

#### Chairman

At every general meeting, the 'Chair' shall be taken by the Chairman of the Board. If at any meeting, the Chairman of the Board is not present within fifteen minutes after the time appointed for holding the meeting or, though present be unwilling to act as chairman, the members present shall choose one of the Directors present to be Chairman or if no Directors shall be present or through present be unwilling to take the Chair then the members present shall choose one of their members being a member, entitled to vote, to be Chairman.

#### Sufficiency of ordinary resolution

Any act or resolution which, under the provisions of this article or of the Companies Act, is permitted shall be sufficiently so done or passed if effected by an ordinary resolution unless either the Companies Act or the Articles specifically require such act to be done or resolution passed as a special resolution.

#### When Quorum not present, meeting to be dissolve and when adjourned

Subject to the provisions of the Companies Act, if within half an hour from the time appointed for the meeting a quorum be not present, the meeting, if converted upon a resolution of the shareholders shall be dissolved but in any other case it shall stand adjourned to the same day in the next week at same time and place, unless the same shall be public holiday when the meeting shall stand adjourned to the next day not being a public holiday at the same time and place and if at such adjourned meeting a quorum be not present within half an hour from the time appointed for the meeting, those members who are present shall be a quorum and may transact the business for which the meeting was called.

#### Power to adjourn general meeting

The chairman of a general meeting may, with the consent of any members of the meeting at which a quorum is present, and shall, if so, directed by the meeting adjourn the same, from time to time and from place to place, but no business shall be transacted at any adjourned meeting other than the business left unfinished at the meeting from which the adjournment took place. When a meeting is adjourned for thirty (30) days or more, notice of the adjourned meeting shall be given as in the case of an original meeting. Save as aforesaid, and as provided in section 103 of the Companies Act, it shall not be necessary to give notice to the members of such adjournment or of the time, date and place appointed for the holding of the adjourned meeting.

#### Business may proceed notwithstanding demand of poll

If a poll be demanded, the demand of a poll shall not prevent the continuance of a meeting or the transaction of any business other than the question on which a poll has been demanded.

## PART II

Part II of the Articles of Association provide for, among other things, the rights of certain shareholders pursuant to the SHA. For more details on the SHA, see "*History and Certain Corporate Matters – Shareholders' Agreements and Other Agreements*" on page 187.

## SECTION IX – OTHER INFORMATION

### MATERIAL CONTRACTS AND DOCUMENTS FOR INSPECTION

The following documents and subsisting contracts (not being contracts entered into in the ordinary course of business carried on by our Company and includes contracts entered into until the date of this Draft Red Herring Prospectus) which are, or may be deemed material, have been entered or to be entered into by our Company. These documents and contracts, copies of which will be attached to the copy of the Red Herring Prospectus and the Prospectus and filed with the RoC, and also the documents for inspection referred to hereunder may be inspected at our Registered Office, from 10.00 am to 4.00 pm on Working Days and on the website of the Company at <https://www.unipartsgroup.com/ipo-material-contracts.asp?links=inv53> from the date of the Red Herring Prospectus until the Bid/Offer Closing Date (except for such contracts and documents that will be executed subsequent to the completion of the Bid/Offer Closing Date).

#### *Material Contracts to the Offer*

1. Offer Agreement dated April 25, 2022 entered into among our Company, the Selling Shareholders and the BRLMs.
2. Registrar Agreement dated April 25, 2022 entered into among our Company, the Selling Shareholders and the Registrar to the Offer.
3. Cash Escrow and Sponsor Bank Agreement dated [●] entered into among our Company, the Selling Shareholders, the BRLMs, the Syndicate Members, Banker(s) to the Offer and the Registrar to the Offer.
4. Share Escrow Agreement dated [●] entered into among the Selling Shareholders, our Company and the Share Escrow Agent.
5. Syndicate Agreement dated [●] entered into among the members of the Syndicate, our Company, the Selling Shareholders and the Registrar to the Offer.
6. Underwriting Agreement dated [●] entered into among our Company, the Selling Shareholders and the Underwriters.

#### *Material Documents*

1. Certified copies of our Memorandum of Association and Articles of Association, as amended until date.
2. Certificate of incorporation dated September 26, 1994 and a certificate of commencement of business dated September 7, 1998.
3. Resolutions of the Board of Directors dated March 30, 2022 approving the Offer and other related matters.
4. Resolution of the Board of Directors of our Company dated April 25, 2022 approving this Draft Red Herring Prospectus for filing with SEBI and the Stock Exchanges.
5. Copies of annual reports for the last three Fiscals, i.e., Fiscal 2021, 2020, 2019.
6. Shareholders' Agreement dated September 25, 2007, entered into by and amongst our Promoters, Ambadevi, Ashoka and our Company as amended by letter agreements dated September 7, 2010 and February 18, 2013.
7. Deed of accession dated May 31, 2012 by which Karan Soni became a party to the Shareholders' Agreement dated September 25, 2007.
8. Deeds of accession each dated July 4, 2012 by which Meher Soni became a party to the Shareholders' Agreement dated September 25, 2007.
9. Supplemental deed dated January 30, 2014 to the Shareholders' Agreement dated September 25, 2007 entered into by and amongst our Promoters, Ambadevi, Ashoka, Karan Soni, Meher Soni and

our Company.

10. Shareholders' Agreement dated May 25, 2007, entered into by and amongst our Promoters, Olsen Investors and our Company.
11. Trust agreements each dated November 15, 2018, deeds of accession each dated December 27, 2018, a supplemental deed (to the Shareholders' Agreement) dated December 27, 2018 and letter agreement dated October 10, 2019 entered into among the SHA Parties and Peak Trust Company-NV.
12. Supplemental deed dated December 7, 2020 entered into amongst Sarabjit Soni, Shrikant Nadkarni, Peak Trust Company – NV, Angad Soni, Arjun Soni, Pamela Soni, Tanya Kohli and the SHA Parties.
13. Amendment and Termination Agreement dated April 19, 2022 entered into amongst Sarabjit Soni Shrikant Nadkarni, Peak Trust Company – NV, Angad Soni, Arjun Soni, Pamela Soni, Tanya Kohli and the SHA Parties.
14. Employment agreement dated April 1, 2016 entered into amongst Gurdeep Soni and GFPL, as last amended on April 1, 2021, and the letter dated April 23, 2022, issued by the Company to him.
15. Employment agreement dated August 27, 2014 entered into amongst Paramjit Singh Soni and UUL, as last amended on April 21, 2022, and the letter dated April 23, 2022, issued by the Company to him.
16. Employment agreement dated January 1, 2012 entered into amongst Herbert Coenen and UIG, as amended by letter dated April 1, 2014 and November 20, 2015.
17. Statement of possible special tax benefits dated April 25, 2022 from the Statutory Auditors included in this Draft Red Herring Prospectus.
18. The examination report of the Statutory Auditor dated March 22, 2022 on the Restated Financial Statements.
19. Consent of the Statutory Auditors dated April 25, 2022 to include their name as required under Section 26(5) of the Companies Act read with SEBI ICDR Regulations and referred to as an “expert” as defined under Section 2(38) of the Companies Act, 2013 to the extent and in their capacity as the Statutory Auditor, and for inclusion of their examination report dated March 22, 2022 on examination of our Restated Financial Statements and the statement of possible special tax benefits dated April 25, 2022 in the form and context in which it appears in this Draft Red Herring Prospectus.
20. Consent dated March 2, 2022, from the chartered engineer, namely D.V Mehta, to include their name in this Draft Red Herring Prospectus and as an “expert” as defined under Section 2(38) of the Companies Act, 2013.
21. Consents dated (i) March 2, 2022, from an independent architect, namely ADI Designs Private Limited, (ii) March 7, 2022 from an independent architect, namely M/S Nirmaan Architects; and (iii) March 3, 2022 from an independent architect, namely, Architects Bureau, to include their names in this Draft Red Herring Prospectus and as “experts” as defined under Section 2(38) of the Companies Act, 2013.
22. Consents of the Selling Shareholders, our Directors, Bankers to our Company, the BRLMs, Registrar to the Offer, Banker(s) to the Offer, Syndicate Members, legal counsels, lenders to the Company, Company Secretary and Compliance Officer of our Company, as referred to act, in their respective capacities.
23. Industry report titled “Global market assessment of 3PL and PMP products in Agriculture and Construction Equipment” dated April, 2022 prepared by CRISIL, commissioned and paid for by our Company, consent letter dated April 22, 2022 issued by CRISIL and engagement letter dated December 15, 2021 amongst the Company and CRISIL.
24. In-principle listing approvals dated [●] and [●] from BSE and NSE, respectively.

25. Tripartite Agreement dated December 18, 2012, among our Company, NSDL and the Registrar to the Offer.
26. Tripartite Agreement dated August 25, 2014, among our Company, CDSL and the Registrar to the Offer.
27. Due diligence certificate to SEBI from the BRLMs, dated April 25, 2022.
28. SEBI final observation letter number [●] dated [●].

Any of the contracts or documents mentioned in this Draft Red Herring Prospectus may be amended or modified at any time if so required in the interest of our Company or if required by the other parties, without reference to the shareholders, subject to compliance with the provisions contained in the Companies Act, 2013 and other applicable law.



## **DECLARATION BY THE COMPANY**

I hereby certify and declare that all relevant provisions of the Companies Act, 2013, the rules, regulations and guidelines issued by the Government of India, or the regulations, rules or guidelines issued by SEBI, established under Section 3 of the SEBI Act, as the case may be, have been complied with and no statement made in this Draft Red Herring Prospectus is contrary to the provisions of the Companies Act, 2013, the SCRA, the SCRR, the SEBI Act, each as amended, or the rules, regulations and guidelines issued thereunder, as the case may be. I further certify that all the disclosures and statements in this Draft Red Herring Prospectus are true and correct.

### **SIGNED BY THE DIRECTOR OF OUR COMPANY**

**Sd.**

\_\_\_\_\_

**Gurdeep Soni**

**(Chairman and Managing Director)**

**Date:** April 25, 2022

**Place:** New Delhi

### **DECLARATION BY THE COMPANY**

I hereby certify and declare that all relevant provisions of the Companies Act, 2013, the rules, regulations and guidelines issued by the Government of India, or the regulations, rules or guidelines issued by SEBI, established under Section 3 of the SEBI Act, as the case may be, have been complied with and no statement made in this Draft Red Herring Prospectus is contrary to the provisions of the Companies Act, 2013, the SCRA, the SCRR, the SEBI Act, each as amended, or the rules, regulations and guidelines issued thereunder, as the case may be. I further certify that all the disclosures and statements in this Draft Red Herring Prospectus are true and correct.

### **SIGNED BY THE DIRECTOR OF OUR COMPANY**

**Sd.** \_\_\_\_\_  
**Paramjit Singh Soni**

**(Executive Director and Vice Chairman)**

**Date:** April 25, 2022

**Place:** U.S.A

### **DECLARATION BY THE COMPANY**

I hereby certify and declare that all relevant provisions of the Companies Act, 2013, the rules, regulations and guidelines issued by the Government of India, or the regulations, rules or guidelines issued by SEBI, established under Section 3 of the SEBI Act, as the case may be, have been complied with and no statement made in this Draft Red Herring Prospectus is contrary to the provisions of the Companies Act, 2013, the SCRA, the SCRR, the SEBI Act, each as amended, or the rules, regulations and guidelines issued thereunder, as the case may be. I further certify that all the disclosures and statements in this Draft Red Herring Prospectus are true and correct.

### **SIGNED BY THE DIRECTOR OF OUR COMPANY**

**Sd.** \_\_\_\_\_  
**Herbert Coenen**

**(Non-Executive Director)**

**Date:** April 25, 2022

**Place:** Germany

### **DECLARATION BY THE COMPANY**

I hereby certify and declare that all relevant provisions of the Companies Act, 2013, the rules, regulations and guidelines issued by the Government of India, or the regulations, rules or guidelines issued by SEBI, established under Section 3 of the SEBI Act, as the case may be, have been complied with and no statement made in this Draft Red Herring Prospectus is contrary to the provisions of the Companies Act, 2013, the SCRA, the SCRR, the SEBI Act, each as amended, or the rules, regulations and guidelines issued thereunder, as the case may be. I further certify that all the disclosures and statements in this Draft Red Herring Prospectus are true and correct.

### **SIGNED BY THE DIRECTOR OF OUR COMPANY**

**Sd.**

\_\_\_\_\_ **Harjit Singh Bhatia**

**(Nominee Director)**

**Date:** April 25, 2022

**Place:** Singapore

### **DECLARATION BY THE COMPANY**

I hereby certify and declare that all relevant provisions of the Companies Act, 2013, the rules, regulations and guidelines issued by the Government of India, or the regulations, rules or guidelines issued by SEBI, established under Section 3 of the SEBI Act, as the case may be, have been complied with and no statement made in this Draft Red Herring Prospectus is contrary to the provisions of the Companies Act, 2013, the SCRA, the SCRR, the SEBI Act, each as amended, or the rules, regulations and guidelines issued thereunder, as the case may be. I further certify that all the disclosures and statements in this Draft Red Herring Prospectus are true and correct.

### **SIGNED BY THE DIRECTOR OF OUR COMPANY**

**Sd.**

\_\_\_\_\_

**Alok Nagory**

**(Independent Director)**

**Date:** April 25, 2022

**Place:** Kanpur

### **DECLARATION BY THE COMPANY**

I hereby certify and declare that all relevant provisions of the Companies Act, 2013, the rules, regulations and guidelines issued by the Government of India, or the regulations, rules or guidelines issued by SEBI, established under Section 3 of the SEBI Act, as the case may be, have been complied with and no statement made in this Draft Red Herring Prospectus is contrary to the provisions of the Companies Act, 2013, the SCRA, the SCRR, the SEBI Act, each as amended, or the rules, regulations and guidelines issued thereunder, as the case may be. I further certify that all the disclosures and statements in this Draft Red Herring Prospectus are true and correct.

### **SIGNED BY THE DIRECTOR OF OUR COMPANY**

**Sd.**

\_\_\_\_\_

**Sharat Krishan Mathur**

**(Independent Director)**

**Date:** April 25, 2022

**Place:** Australia

### **DECLARATION BY THE COMPANY**

I hereby certify and declare that all relevant provisions of the Companies Act, 2013, the rules, regulations and guidelines issued by the Government of India, or the regulations, rules or guidelines issued by SEBI, established under Section 3 of the SEBI Act, as the case may be, have been complied with and no statement made in this Draft Red Herring Prospectus is contrary to the provisions of the Companies Act, 2013, the SCRA, the SCRR, the SEBI Act, each as amended, or the rules, regulations and guidelines issued thereunder, as the case may be. I further certify that all the disclosures and statements in this Draft Red Herring Prospectus are true and correct.

### **SIGNED BY THE DIRECTOR OF OUR COMPANY**

**Sd.** \_\_\_\_\_  
**Shradha Suri**

**(Independent Director)**

**Date:** April 25, 2022

**Place:** New Delhi

### **DECLARATION BY THE COMPANY**

I hereby certify and declare that all relevant provisions of the Companies Act, 2013, the rules, regulations and guidelines issued by the Government of India, or the regulations, rules or guidelines issued by SEBI, established under Section 3 of the SEBI Act, as the case may be, have been complied with and no statement made in this Draft Red Herring Prospectus is contrary to the provisions of the Companies Act, 2013, the SCRA, the SCRR, the SEBI Act, each as amended, or the rules, regulations and guidelines issued thereunder, as the case may be. I further certify that all the disclosures and statements in this Draft Red Herring Prospectus are true and correct.

### **SIGNED BY THE DIRECTOR OF OUR COMPANY**

**Sd.**

\_\_\_\_\_

**Sanjeev Kumar Chanana**

**(Independent Director)**

**Date:** April 25, 2022

**Place:** New Delhi



### **DECLARATION BY THE COMPANY**

I hereby certify and declare that all relevant provisions of the Companies Act, 2013, the rules, regulations and guidelines issued by the Government of India, or the regulations, rules or guidelines issued by SEBI, established under Section 3 of the SEBI Act, as the case may be, have been complied with and no statement made in this Draft Red Herring Prospectus is contrary to the provisions of the Companies Act, 2013, the SCRA, the SCRR, the SEBI Act, each as amended, or the rules, regulations and guidelines issued thereunder, as the case may be. I further certify that all the disclosures and statements in this Draft Red Herring Prospectus are true and correct.

### **SIGNED BY THE CHIEF FINANCIAL OFFICER OF OUR COMPANY**

**Sd.**

\_\_\_\_\_

**Munish Sapra**

**(Chief Financial Officer)**

**Date:** April 25, 2022

**Place:** New Delhi

## **DECLARATION BY SELLING SHAREHOLDER**

We, **Ashoka Investment Holdings Limited**, hereby confirm that all statements and undertakings specifically made by us in this Draft Red Herring Prospectus in relation to ourselves, as a Selling Shareholder and the Equity Shares being offered by us in the Offer for Sale, are true and correct. We assume no responsibility for any other statements, disclosures or undertakings, including any of the statements, disclosures or undertakings made or confirmed by the Company, any other Selling Shareholder or any other person(s) in this Draft Red Herring Prospectus.

**For and on behalf of Ashoka Investment Holdings Limited**

**Sd.** \_\_\_\_\_  
**Authorised Signatory**

**Name: Sangeeta Bissessur**

**Designation:** Director

**Date:** April 25, 2022

**Place:** Mauritius

## **DECLARATION BY SELLING SHAREHOLDER**

We, **Ambadevi Mauritius Holding Limited**, hereby confirm that all statements and undertakings specifically made by us in this Draft Red Herring Prospectus in relation to ourselves, as a Selling Shareholder and the Equity Shares being offered by us in the Offer for Sale, are true and correct. We assume no responsibility for any other statements, disclosures or undertakings, including any of the statements, disclosures or undertakings made or confirmed by the Company, any other Selling Shareholder or any other person(s) in this Draft Red Herring Prospectus.

**For and on behalf of Ambadevi Mauritius Holding Limited**

**Sd.** \_\_\_\_\_  
**Authorised Signatory**

**Name:** Fareed Soreefan

**Designation:** Director

**Date:** April 25, 2022

**Place:** Mauritius

## DECLARATION BY SELLING SHAREHOLDER

We, **Karan Soni 2018 CG-NG Nevada Trust (through Peak Trust Company-NV)**, hereby confirm that all statements and undertakings specifically made by us in this Draft Red Herring Prospectus in relation to ourselves, as a Selling Shareholder and the Equity Shares being offered by us in the Offer for Sale, are true and correct. We assume no responsibility for any other statements, disclosures or undertakings, including any of the statements, disclosures or undertakings made or confirmed by the Company, any other Selling Shareholder or any other person(s) in this Draft Red Herring Prospectus.

**For and on behalf of Karan Soni 2018 CG-NG Nevada Trust (through Peak Trust Company-NV)**

**Sd.** \_\_\_\_\_

**Name:** Brandon J. Cintula

**Designation:** Chief Operating Officer and Chief Fiduciary Officer  
Peak Trust Company-NV, Trustee

**Date:** April 25, 2022

**Place:** Las Vegas, Nevada

## DECLARATION BY SELLING SHAREHOLDER

We, **Meher Soni 2018 CG-NG Nevada Trust (through Peak Trust Company-NV)**, hereby confirm that all statements and undertakings specifically made by us in this Draft Red Herring Prospectus in relation to ourselves, as a Selling Shareholder and the Equity Shares being offered by us in the Offer for Sale, are true and correct. We assume no responsibility for any other statements, disclosures or undertakings, including any of the statements, disclosures or undertakings made or confirmed by the Company, any other Selling Shareholder or any other person(s) in this Draft Red Herring Prospectus.

**For and on behalf of Meher Soni 2018 CG-NG Nevada Trust (through Peak Trust Company-NV)**

**Sd.**

\_\_\_\_\_  
**Name:** Brandon J. Cintula

**Designation:** Chief Operating Officer and Chief Fiduciary Officer  
Peak Trust Company-NV, Trustee

**Date:** April 25, 2022

**Place:** Las Vegas, Nevada

## **DECLARATION BY SELLING SHAREHOLDER**

I, **Pamela Soni**, hereby confirm that all statements and undertakings specifically made by me in this Draft Red Herring Prospectus in relation to myself, as a Selling Shareholder and the Equity Shares being offered by me in the Offer for Sale, are true and correct. I assume no responsibility for any other statements, disclosures or undertakings, including any of the statements, disclosures or undertakings made or confirmed by the Company, any other Selling Shareholder or any other person(s) in this Draft Red Herring Prospectus.

**Pamela Soni**

**Sd.** \_\_\_\_\_

**Name: Pamela Soni**

**Date:** April 25, 2022

**Place:** New Delhi

## DECLARATION BY SELLING SHAREHOLDER

I, **Andrew Warren Code**, hereby confirm that all statements and undertakings specifically made by me in this Draft Red Herring Prospectus in relation to myself, as a Selling Shareholder and the Equity Shares being offered by me in the Offer for Sale, are true and correct. I assume no responsibility for any other statements, disclosures or undertakings, including any of the statements, disclosures or undertakings made or confirmed by the Company, any other Selling Shareholder or any other person(s) in this Draft Red Herring Prospectus.

**Sd.** \_\_\_\_\_

**Name:** Andrew Warren Code

**Date:** April 25, 2022

**Place:** Illinois

## DECLARATION BY SELLING SHAREHOLDER

I, **James Norman Hallene**, hereby confirm that all statements and undertakings specifically made by me in this Draft Red Herring Prospectus in relation to myself, as a Selling Shareholder and the Equity Shares being offered by me in the Offer for Sale, are true and correct. I assume no responsibility for any other statements, disclosures or undertakings, including any of the statements, disclosures or undertakings made or confirmed by the Company, any other Selling Shareholder or any other person(s) in this Draft Red Herring Prospectus.

**Sd.** \_\_\_\_\_

**Name:** James Norman Hallene

**Date:** April 25, 2022

**Place:** Florida



## DECLARATION BY SELLING SHAREHOLDER

I, **Kevin John Code**, hereby confirm that all statements and undertakings specifically made by me in this Draft Red Herring Prospectus in relation to myself, as a Selling Shareholder and the Equity Shares being offered by me in the Offer for Sale, are true and correct. I assume no responsibility for any other statements, disclosures or undertakings, including any of the statements, disclosures or undertakings made or confirmed by the Company, any other Selling Shareholder or any other person(s) in this Draft Red Herring Prospectus.

**Sd.** \_\_\_\_\_

**Name:** Kevin John Code

**Date:** April 25, 2022

**Place:** Florida

## DECLARATION BY SELLING SHAREHOLDER

I, **Dennis Francis DeDecker**, hereby confirm that all statements and undertakings specifically made by me in this Draft Red Herring Prospectus in relation to myself, as a Selling Shareholder and the Equity Shares being offered by me in the Offer for Sale, are true and correct. I assume no responsibility for any other statements, disclosures or undertakings, including any of the statements, disclosures or undertakings made or confirmed by the Company, any other Selling Shareholder or any other person(s) in this Draft Red Herring Prospectus.

**Sd.** \_\_\_\_\_

**Name:** Dennis Francis DeDecker

**Date:** April 25, 2022

**Place:** Illinois

### **DECLARATION BY SELLING SHAREHOLDER**

I, **Melvin Keith Gibbs**, hereby confirm that all statements and undertakings specifically made by me in this Draft Red Herring Prospectus in relation to myself, as a Selling Shareholder and the Equity Shares being offered by me in the Offer for Sale, are true and correct. I assume no responsibility for any other statements, disclosures or undertakings, including any of the statements, disclosures or undertakings made or confirmed by the Company, any other Selling Shareholder or any other person(s) in this Draft Red Herring Prospectus.

**Sd.** \_\_\_\_\_

**Name:** Melvin Keith Gibbs

**Date:** April 25, 2022

**Place:** Illinois

## DECLARATION BY SELLING SHAREHOLDER

I, **Walter James Gruber**, hereby confirm that all statements and undertakings specifically made by me in this Draft Red Herring Prospectus in relation to myself, as a Selling Shareholder and the Equity Shares being offered by me in the Offer for Sale, are true and correct. I assume no responsibility for any other statements, disclosures or undertakings, including any of the statements, disclosures or undertakings made or confirmed by the Company, any other Selling Shareholder or any other person(s) in this Draft Red Herring Prospectus.

**Sd.** \_\_\_\_\_

**Name:** Walter James Gruber

**Date:** April 25, 2022

**Place:** Iowa

## DECLARATION BY SELLING SHAREHOLDER

I, **Wendy Reichard Hammen**, hereby confirm that all statements and undertakings specifically made by me in this Draft Red Herring Prospectus in relation to myself, as a Selling Shareholder and the Equity Shares being offered by me in the Offer for Sale, are true and correct. I assume no responsibility for any other statements, disclosures or undertakings, including any of the statements, disclosures or undertakings made or confirmed by the Company, any other Selling Shareholder or any other person(s) in this Draft Red Herring Prospectus.

**Sd.** \_\_\_\_\_

**Name:** Wendy Reichard Hammen

**Date:** April 25, 2022

**Place:** Iowa

## **DECLARATION BY SELLING SHAREHOLDER**

I, **Mark Louis Dawson**, hereby confirm that all statements and undertakings specifically made by me in this Draft Red Herring Prospectus in relation to myself, as a Selling Shareholder and the Equity Shares being offered by me in the Offer for Sale, are true and correct. I assume no responsibility for any other statements, disclosures or undertakings, including any of the statements, disclosures or undertakings made or confirmed by the Company, any other Selling Shareholder or any other person(s) in this Draft Red Herring Prospectus.

**Sd.** \_\_\_\_\_

**Name:** Mark Louis Dawson

**Date:** April 25, 2022

**Place:** Iowa

## DECLARATION BY SELLING SHAREHOLDER

I, **Bradley Lorenz Miller**, hereby confirm that all statements and undertakings specifically made by me in this Draft Red Herring Prospectus in relation to myself, as a Selling Shareholder and the Equity Shares being offered by me in the Offer for Sale, are true and correct. I assume no responsibility for any other statements, disclosures or undertakings, including any of the statements, disclosures or undertakings made or confirmed by the Company, any other Selling Shareholder or any other person(s) in this Draft Red Herring Prospectus.

**Sd.** \_\_\_\_\_

**Name:** Bradley Lorenz Miller

**Date:** April 25, 2022

**Place:** Iowa

### **DECLARATION BY SELLING SHAREHOLDER**

I, **Mary Louise Arp**, hereby confirm that all statements and undertakings specifically made by me in this Draft Red Herring Prospectus in relation to myself, as a Selling Shareholder and the Equity Shares being offered by me in the Offer for Sale, are true and correct. I assume no responsibility for any other statements, disclosures or undertakings, including any of the statements, disclosures or undertakings made or confirmed by the Company, any other Selling Shareholder or any other person(s) in this Draft Red Herring Prospectus.

**Sd.** \_\_\_\_\_

**Name:** Mary Louise Arp

**Date:** April 25, 2022

**Place:** Iowa



## **DECLARATION BY SELLING SHAREHOLDER**

I, **Diana Lynn Craig**, hereby confirm that all statements and undertakings specifically made by me in this Draft Red Herring Prospectus in relation to myself, as a Selling Shareholder and the Equity Shares being offered by me in the Offer for Sale, are true and correct. I assume no responsibility for any other statements, disclosures or undertakings, including any of the statements, disclosures or undertakings made or confirmed by the Company, any other Selling Shareholder or any other person(s) in this Draft Red Herring Prospectus.

**Sd.**

\_\_\_\_\_  
**Name: Diana Lynn Craig**

**Date:** April 25, 2022

**Place:** Iowa

## **DECLARATION BY SELLING SHAREHOLDER**

I, **Marc Christopher Dorau**, hereby confirm that all statements and undertakings specifically made by me in this Draft Red Herring Prospectus in relation to myself, as a Selling Shareholder and the Equity Shares being offered by me in the Offer for Sale, are true and correct. I assume no responsibility for any other statements, disclosures or undertakings, including any of the statements, disclosures or undertakings made or confirmed by the Company, any other Selling Shareholder or any other person(s) in this Draft Red Herring Prospectus.

**Sd.** \_\_\_\_\_

**Name:** Marc Christopher Dorau

**Date:** April 25, 2022

**Place:** California

### **DECLARATION BY SELLING SHAREHOLDER**

I, **Craig A Johnson**, hereby confirm that all statements and undertakings specifically made by me in this Draft Red Herring Prospectus in relation to myself, as a Selling Shareholder and the Equity Shares being offered by me in the Offer for Sale, are true and correct. I assume no responsibility for any other statements, disclosures or undertakings, including any of the statements, disclosures or undertakings made or confirmed by the Company, any other Selling Shareholder or any other person(s) in this Draft Red Herring Prospectus.

**Sd.** \_\_\_\_\_

**Name: Craig A Johnson**

**Date: April 25, 2022**

**Place: Illinois**

### **DECLARATION BY SELLING SHAREHOLDER**

I, **Misty Marie Garcia**, hereby confirm that all statements and undertakings specifically made by me in this Draft Red Herring Prospectus in relation to myself, as a Selling Shareholder and the Equity Shares being offered by me in the Offer for Sale, are true and correct. I assume no responsibility for any other statements, disclosures or undertakings, including any of the statements, disclosures or undertakings made or confirmed by the Company, any other Selling Shareholder or any other person(s) in this Draft Red Herring Prospectus.

**Sd.** \_\_\_\_\_

**Name:** Misty Marie Garcia

**Date:** April 25, 2022

**Place:** Iowa